

## TRANSISTOR(NPN)

### FEATURE

- Complementary NPN Type available ( 2N2907A)

### TO-92

- EMITTER
- BASE
- COLLECTOR

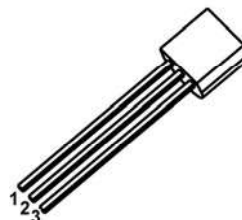

### MARKING

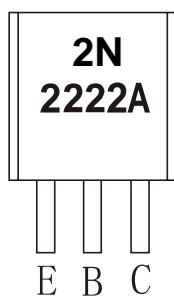

2N2222A=Device code

### Equivalent Circuit

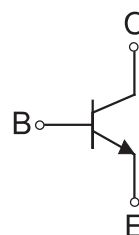

### ORDERING INFORMATION

Part Number	Package	Packing Method	Pack Quantity
2N2222A	TO-92	Bulk	1000pcs/Bag
2N2222A-TA	TO-92	Tape	2000pcs/Box

### MAXIMUM RATINGS (T<sub>a</sub>=25°C unless otherwise noted)

Symbol	Parameter	Value	Unit
V <sub>CB0</sub>	Collector-Base Voltage	75	V
V <sub>CEO</sub>	Collector-Emitter Voltage	40	V
V <sub>EB0</sub>	Emitter-Base Voltage	6	V
I <sub>C</sub>	Collector Current -Continuous	0.6	A
P <sub>D</sub>	Collector Power Dissipation	625	mW
R <sub>θJA</sub>	Thermal Resistance from Junction to Ambient	200	°C /W
T <sub>J</sub> ,T <sub>stg</sub>	Operation Junction and Storage Temperature Range	-55~+150	°C

## ELECTRICAL CHARACTERISTICS

$T_a=25^\circ\text{C}$  unless otherwise specified

Parameter	Symbol	Test conditions	Min	Max	Unit
Collector-base breakdown voltage	$V_{(BR)CBO}$	$I_C=10\mu\text{A}, I_E=0$	75		V
Collector-emitter breakdown voltage	$V_{(BR)CEO}$	$I_C=10\text{mA}, I_B=0$	40		V
Emitter-base breakdown voltage	$V_{(BR)EBO}$	$I_E=10\mu\text{A}, I_C=0$	6		V
Collector cut-off current	$I_{CBO}$	$V_{CB}=60\text{V}, I_E=0$		10	nA
Collector cut-off current	$I_{CEX}$	$V_{CE}=60\text{V}, V_{EB(Off)}=3\text{V}$		10	nA
Emitter cut-off current	$I_{EBO}$	$V_{EB}=3\text{V}, I_C=0$		100	nA
DC current gain	$h_{FE(1)}$	$V_{CE}=10\text{V}, I_C=150\text{mA}$	100	300	
	$h_{FE(2)}$	$V_{CE}=10\text{V}, I_C=0.1\text{mA}$	40		
	$h_{FE(3)}$ *	$V_{CE}=10\text{V}, I_C=500\text{mA}$	42		
Collector-emitter saturation voltage	$V_{CE(sat)(1)}$ *	$I_C=500\text{mA}, I_B=50\text{mA}$		0.6	V
	$V_{CE(sat)(2)}$ *	$I_C=150\text{mA}, I_B=15\text{mA}$		0.3	V
Base-emitter saturation voltage	$V_{BE(sat)}$ *	$I_C=500\text{mA}, I_B=50\text{mA}$		1.2	V
Delay time	$t_d$	$V_{CC}=30\text{V}, V_{EB(Off)}=-0.5\text{V},$		10	nS
Rise time	$t_r$	$I_C=150\text{mA}, I_{B1}=15\text{mA}$		25	nS
Storage time	$t_s$	$V_{CC}=30\text{V}, I_C=150\text{mA}, I_{B1}=I_{B2}=15\text{mA}$		225	nS
Fall time	$t_f$		60	nS	
Transition frequency	$f_T$	$V_{CE}=20\text{V}, I_C=20\text{mA}, f=100\text{MHz}$	300		MHz

\* pulse test

**Typical Characteristics**

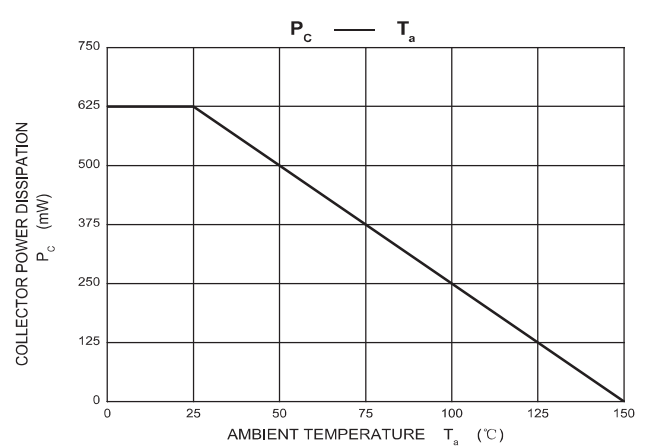
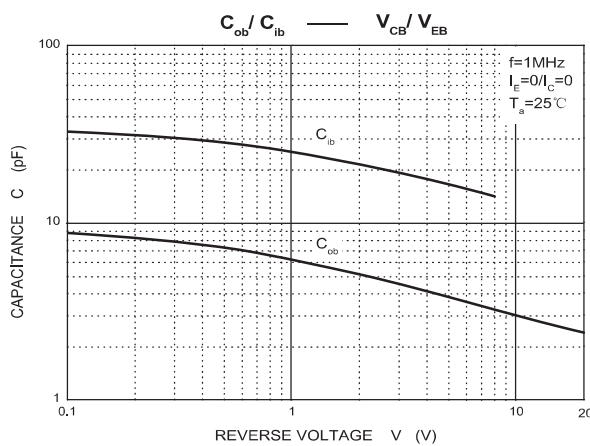
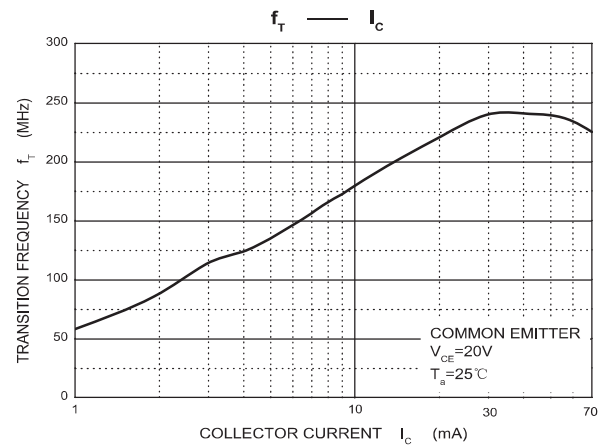
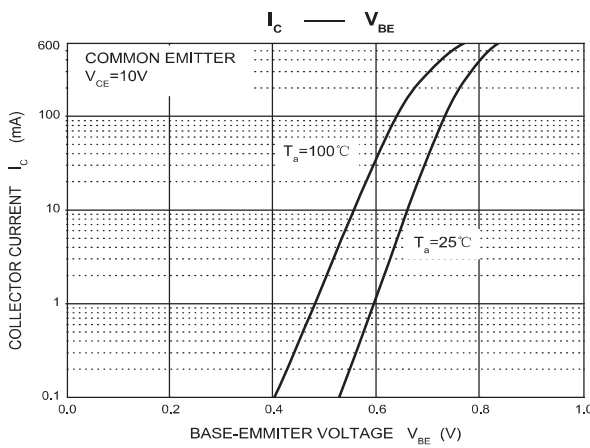
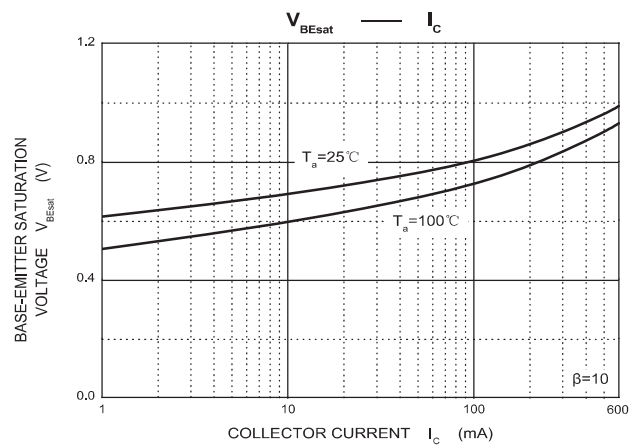
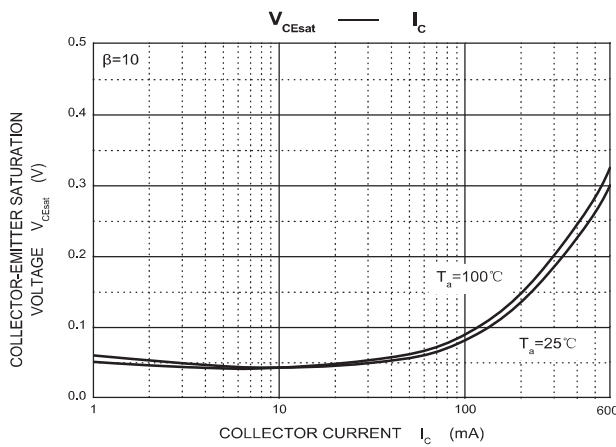
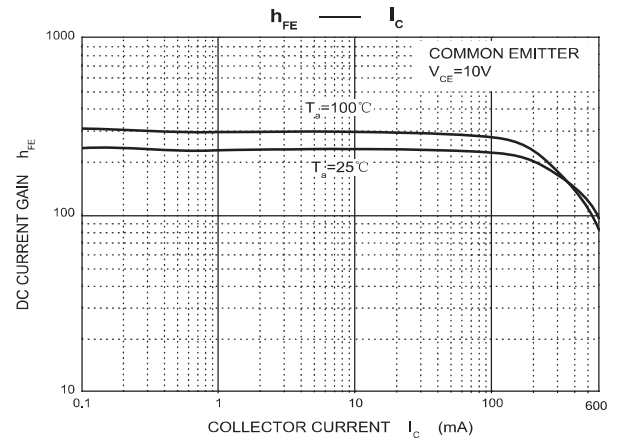
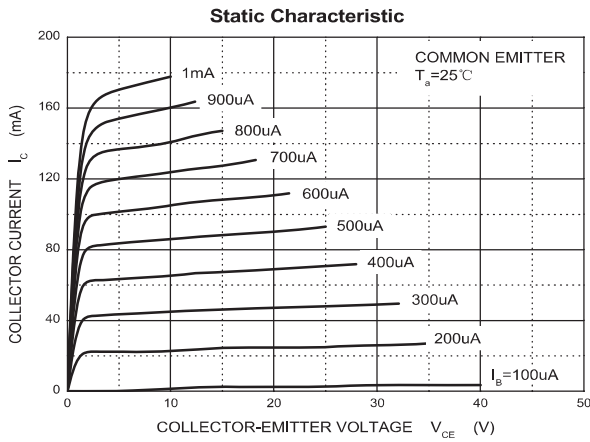

**TO-92 Package Outline Dimensions**

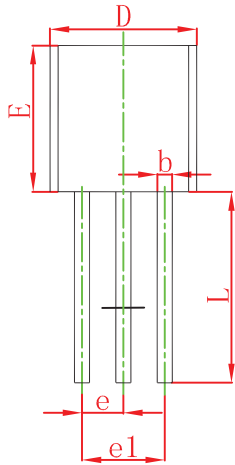
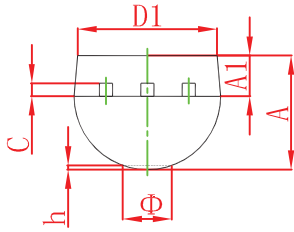

Symbol	Dimensions In Millimeters		Dimensions In Inches	
	Min	Max	Min	Max
A	3.300	3.700	0.130	0.146
A1	1.100	1.400	0.043	0.055
b	0.380	0.550	0.015	0.022
c	0.360	0.510	0.014	0.020
D	4.300	4.700	0.169	0.185
D1	3.430		0.135	
E	4.300	4.700	0.169	0.185
e	1.270 TYP		0.050 TYP	
e1	2.440	2.640	0.096	0.104
L	14.100	14.500	0.555	0.571
Φ		1.600		0.063
h	0.000	0.380	0.000	0.015

**TO-92 Suggested Pad Layout**

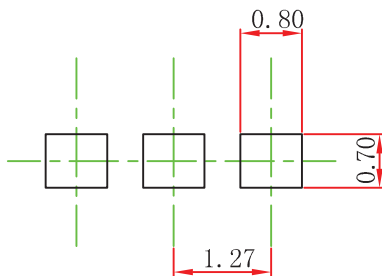

- Note:
1. Controlling dimension: in millimeters.
  2. General tolerance: ± 0.05mm.
  3. The pad layout is for reference purposes only.

**TO-92 Tape and Reel**

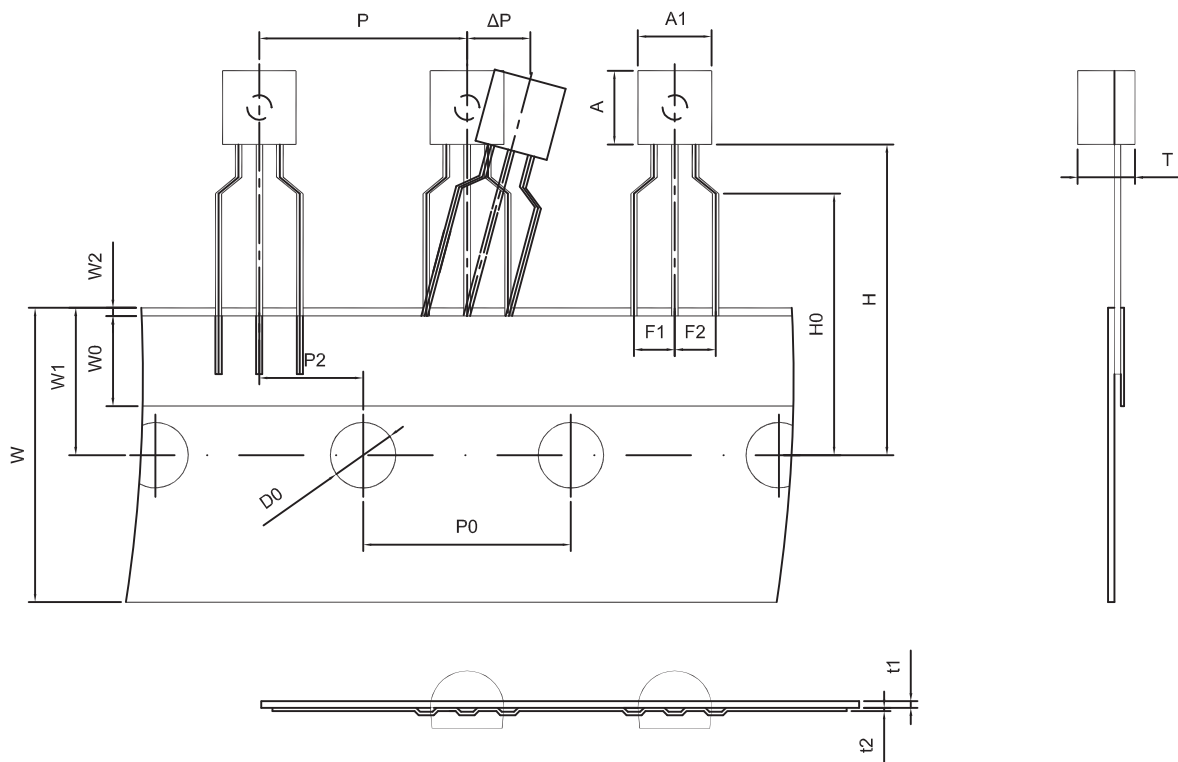

Dimensions are in millimeter								
A1	A	T	P	P0	P2	F1	F2	W
4.5	4.5	3.5	12.7	12.7	6.35	2.5	2.5	18.0
W0	W1	W2	H	H0	D0	t1	t2	$\Delta P$
6.0	9.0	1.0 MAX.	19.0	16.0	4.0	0.4	0.2	0

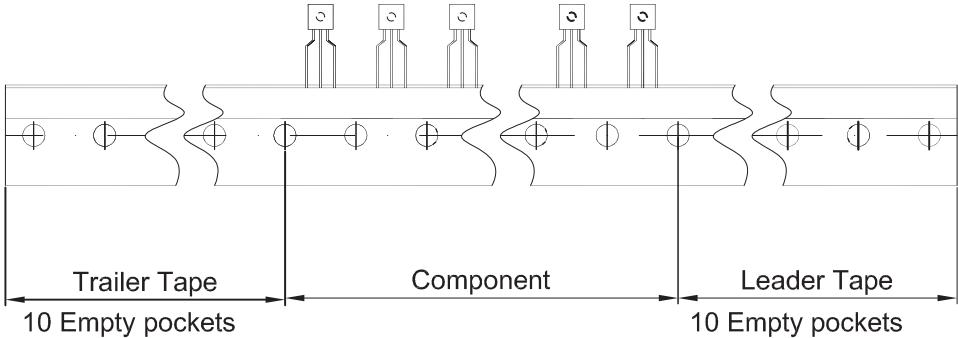

Package	Box	Box Size(mm)	Carton	Carton Size(mm)
TO-92	2000 pcs	333×162×43	20,000 pcs	350×340×250