

TO-92L Plastic-Encapsulate Transistors TRANSISTOR (NPN)

FEATURES

- Low Saturation Voltage: $V_{CE(sat)}=0.5V(\text{Max})(I_C=1A)$
- High Speed Switching Time: $t_{stg}=1\mu s(\text{Typ.})$
- Complementary to 2SA1020

TO-92L

- 1.EMITTER
 2.COLLECTOR
 3.BASE

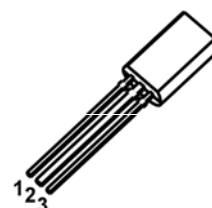

MARKING



C2655=Device code
 XXX=Code

Equivalent Circuit

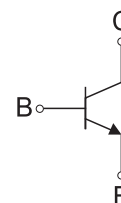

ORDERING INFORMATION

Part Number	Package	Packing Method	Pack Quantity
2SC2655	TO-92L	Bulk	500pcs/Bag
2SC2655-TA	TO-92L	Tape	2000pcs/Box

MAXIMUM RATINGS ($T_a=25^\circ\text{C}$ unless otherwise noted)

Symbol	Parameter	Symbol	Unit
V_{CBO}	Collector-Base Voltage	50	V
V_{CEO}	Collector-Emitter Voltage	50	V
V_{EBO}	Emitter-Base Voltage	5	V
I_C	Collector Current –Continuous	2	A
P_C	Collector Power Dissipation	0.9	W
T_J, T_{stg}	Operation Junction and Storage Temperature Range	-55-150	$^\circ\text{C}$

ELECTRICAL CHARACTERISTICS

$T_a=25^\circ\text{C}$ unless otherwise specified

Parameter	Symbol	Test conditions	Min	Typ	Max	Unit
Collector-base breakdown voltage	$V_{(BR)CBO}$	$I_C=100\mu\text{A}, I_E=0$	50			V
Collector-emitter breakdown voltage	$V_{(BR)CEO}$	$I_C=10\text{mA}, I_B=0$	50			V
Emitter-base breakdown voltage	$V_{(BR)EBO}$	$I_E=100\mu\text{A}, I_C=0$	5			V
Collector cut-off current	I_{CBO}	$V_{CB}=50\text{V}, I_E=0$			1	μA
Emitter cut-off current	I_{EBO}	$V_{EB}=5\text{V}, I_C=0$			1	μA
DC current gain	$h_{FE(1)}$	$V_{CE}=2\text{V}, I_C=500\text{mA}$	70		240	
	$h_{FE(2)}$	$V_{CE}=2\text{V}, I_C=1.5\text{A}$	40			
Collector-emitter saturation voltage	$V_{CE(sat)}$	$I_C=1\text{A}, I_B=0.05\text{A}$			0.5	V
Base-emitter saturation voltage	$V_{BE(sat)}$	$I_C=1\text{A}, I_B=0.05\text{A}$			1.2	V
Transition frequency	f_T	$V_{CE}=2\text{V}, I_C=0.5\text{A}$		100		MHz
Collector output capacitance	C_{ob}	$V_{CB}=10\text{V}, I_E=0, f=1\text{MHz}$		30		pF
Switch time	Tune on Time	t_{on}	$V_{CC}=30\text{V}, I_C=1\text{A},$ $I_{B1}=-I_{B2}=0.05\text{A}$	0.1		μs
	Storage Time	t_{stg}		1		
	Fall Time	t_f		0.1		

CLASSIFICATION OF $h_{FE(1)}$

Rank	O	Y
Range	70-140	120-240

Typical Characteristics

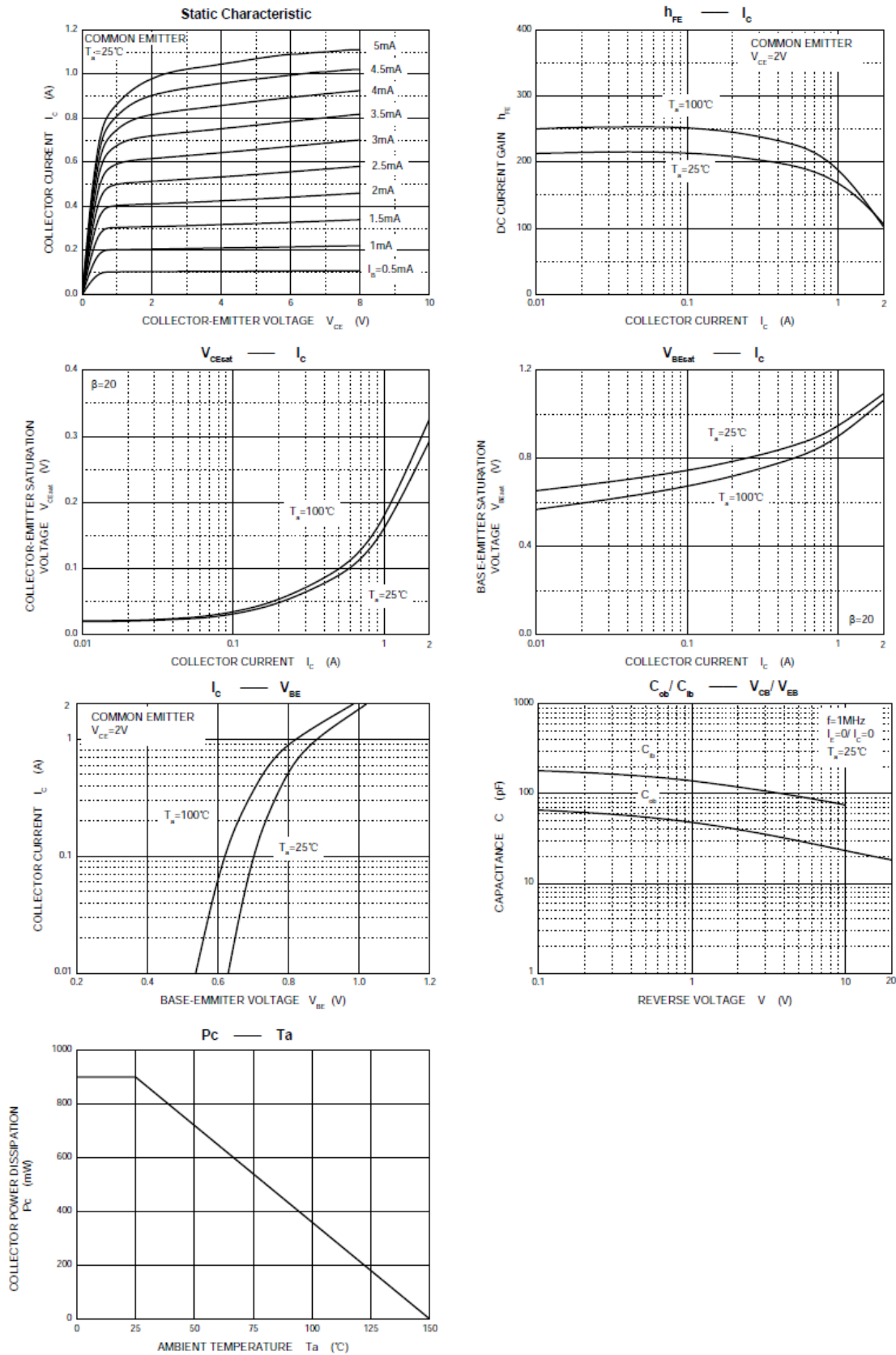

TO-92L Package Outline Dimensions

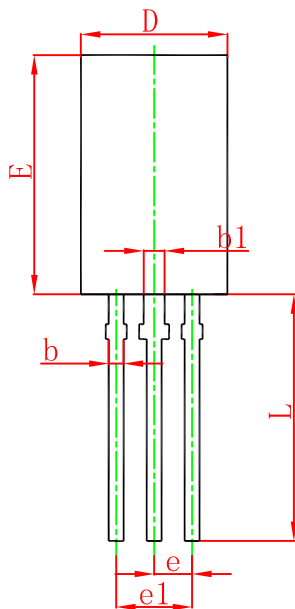
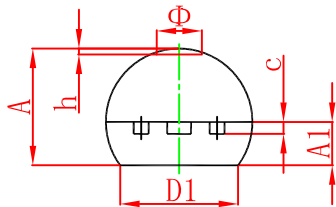

Symbol	Dimensions In Millimeters		Dimensions In Inches	
	Min.	Max.	Min.	Max.
A	3.750	4.050	0.148	0.159
A1	1.280	1.580	0.050	0.062
b	0.380	0.550	0.015	0.022
b1	0.620	0.780	0.024	0.031
c	0.350	0.450	0.014	0.018
D	4.750	5.050	0.187	0.199
D1	4.000		0.157	
E	7.850	8.150	0.309	0.321
e	1.270 TYP.		0.050 TYP.	
e1	2.440	2.640	0.096	0.104
L	13.800	14.200	0.543	0.559
Φ		1.600		0.063
h	0.000	0.300	0.000	0.012

TO-92L Suggested Pad Layout

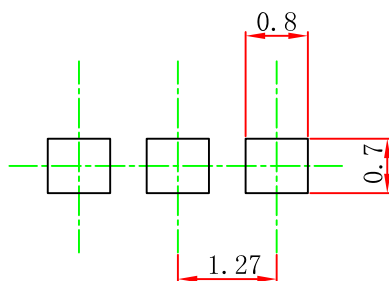

- Note:
1. Controlling dimension: in millimeters.
 2. General tolerance: $\pm 0.05\text{mm}$.
 3. The pad layout is for reference purposes only.

TO-92L PACKAGE TAPING DIMENSION

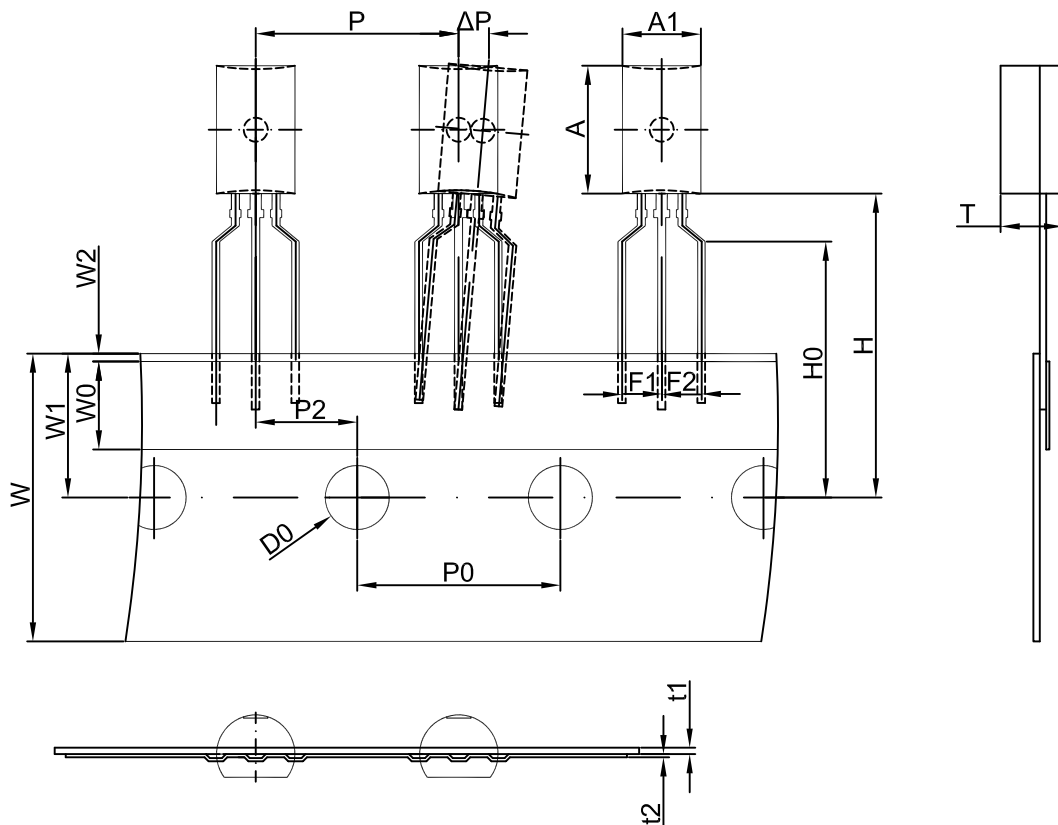

Dimensions are in millimeter

A1	A	T	P	P0	P2	F1	F2	W
4.9	8.0	3.9	12.7	12.7	6.35	2.5	2.5	18.0
W0	W1	W2	H	H0	D0	t1	t2	ΔP
6.0	9.0	1.0	19.0	16.0	4.0	0.4	0.2	0

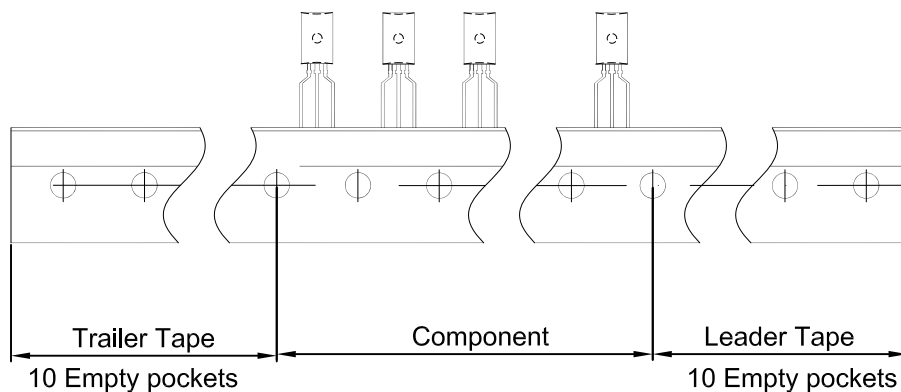

Package	Box	Box Size(mm)	Carton	Carton Size(mm)
TO-92L	2000 pcs	333×203×42	20,000 pcs	493×400×264