

SMAF Plastic-Encapsulate Diodes

Low VF Schottky Rectifier Diodes

Features:

- $I_{F(AV)}$ 5A
- V_{RRM} 20V-200V
- High surge current capability
- Polarity: Color band denotes cathode

Applications:

- Rectifier

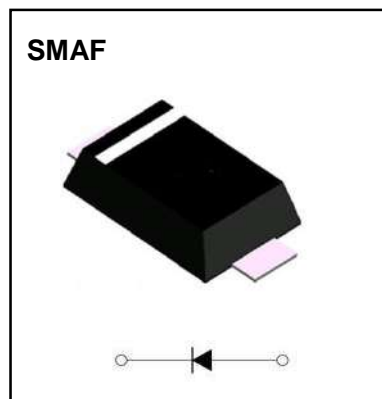

Marking

- SS5XL
- X : From 2 To 20

Limiting Values(Absolute Maximum Rating)

Item	Symbol	Unit	Test Conditions	KSS5														
				2LF	3LF	4LF	5LF	6LF	8LF	10LF	15LF	20LF						
Repetitive Peak Reverse Voltage	V_{RRM}	V		20	30	40	50	60	80	100	150	200						
Maximum RMS Voltage	V_{RMS}	V		14	21	28	35	42	56	70	105	140						
Average Forward Current	$I_{F(AV)}$	A	60Hz Half-sine wave , Resistance load , TL(Fig.1)	5.0														
Surge(Non-repetitive)Forward Current	I_{FSM}	A	60Hz Half-sine wave , 1 cycle , $T_a=25^{\circ}C$	120														
Junction Temperature	T_J	$^{\circ}C$		-55~+150														
Storage Temperature	T_{STG}	$^{\circ}C$		-55 ~ +150														

Electrical Characteristics ($T = 25^{\circ}C$ Unless otherwise specified)

Item	Symbol	Unit	Test Condition	KSS5														
				2LF	3LF	4LF	5LF	6LF	8LF	10LF	15LF	20LF						
Peak Forward Voltage	V_F	V	$I_F=5.0A$	0.45		0.55		0.72		0.83								
Peak Reverse Current	I_{RRM1}	mA	$V_{RM}=V_{RRM}$	$T_a = 25^{\circ}C$		0.2												
	I_{RRM2}			$T_a = 100^{\circ}C$		5.0												
Thermal Resistance(Typical)	$R_{\theta J-A}$	$^{\circ}C/W$	Between junction and ambient	55														
	$R_{\theta J-L}$	$^{\circ}C/W$	Between junction and terminal	17														

Notes:

Thermal resistance from junction to ambient and from junction to lead mounted on P.C.B. with 0.2" x 0.2" (5.0 mm x 5.0 mm) copper pad areas

Typical Characteristics

FIG.1: FORWARD CURRENT DERATING CURVE

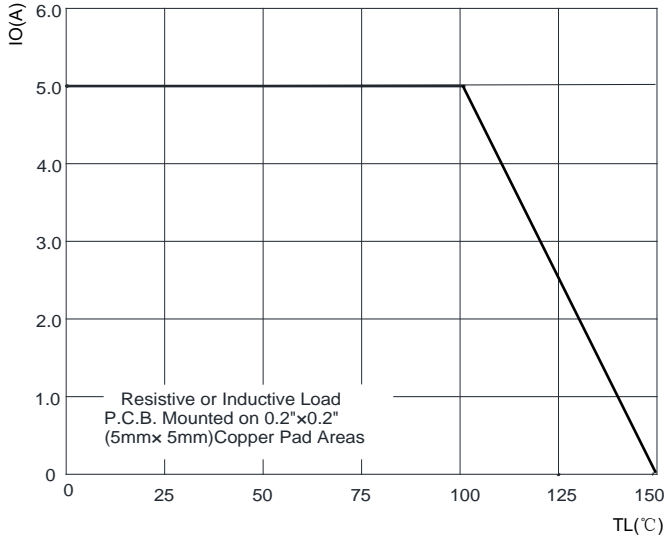

FIG.2: MAXIMUM NON-REPETITIVE FORWARD URGE CURRENT

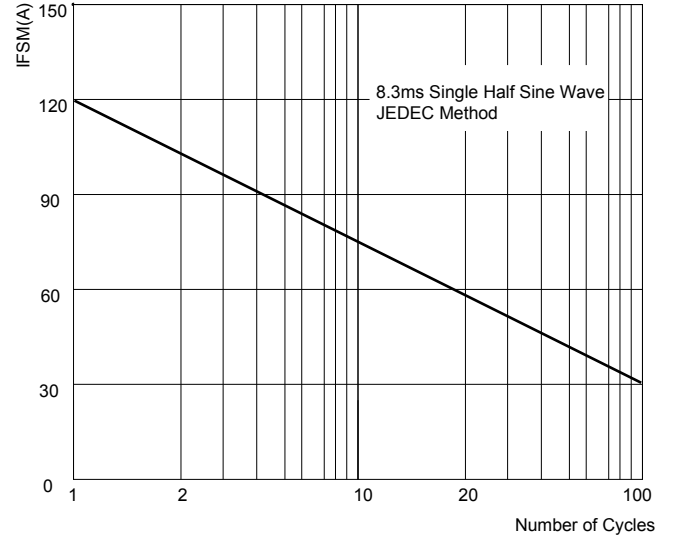

FIG.3: TYPICAL FORWARD CHARACTERISTICS

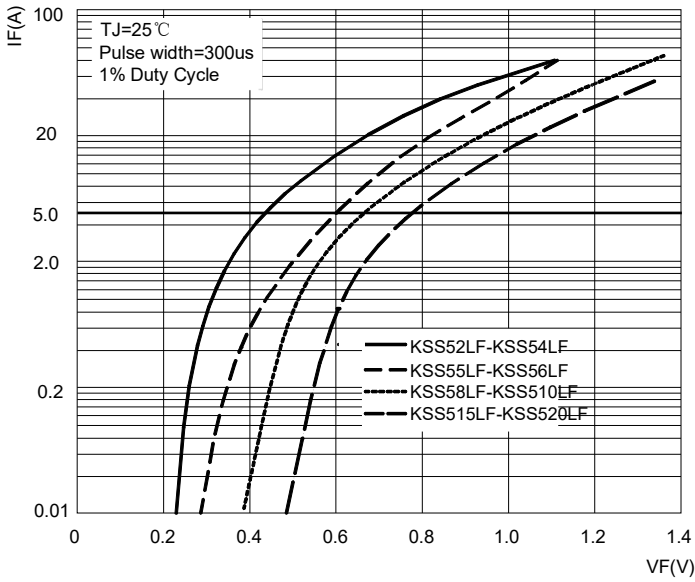
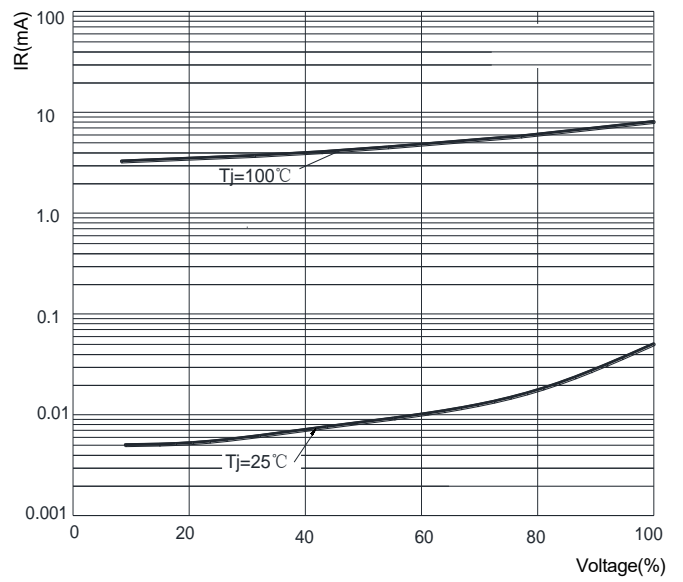
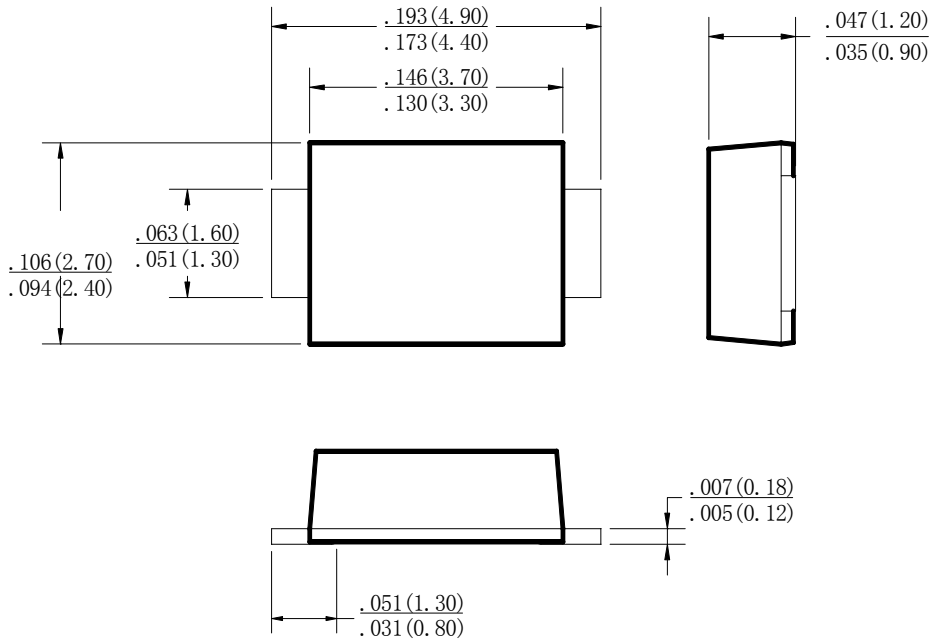

FIG.4: TYPICAL REVERSE CHARACTERISTICS



SMAF Package Outline Dimensions



Dimensions in inches and (millimeters)

SMAF Suggested Pad Layout

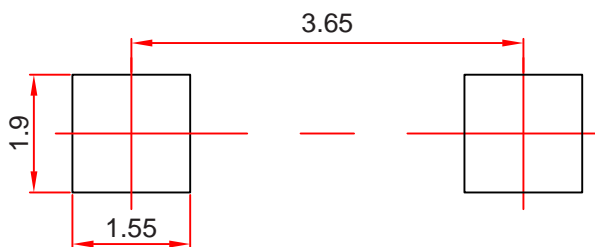

Note:

1. Controlling dimension: in millimeters.
2. General tolerance: $\pm 0.05\text{mm}$.
3. The pad layout is for reference purposes only.

Reel Taping Specifications For Surface Mount Devices- SMAF

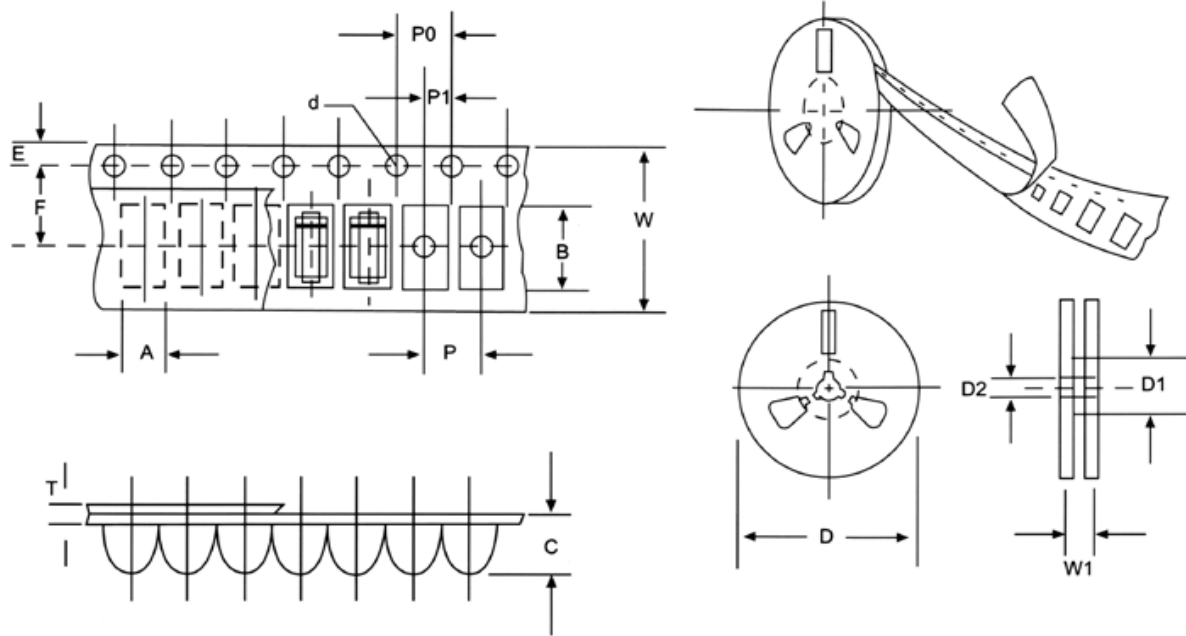

FIG: CONFIGURATION OF SURFACE MOUNTED DEVICES TAPING

ITEM	SYMBOL	SMAF mm(inch)
Carrier width	A	2.83+0.1(0.112+0.004)
Carrier length	B	4.90+0.1(0.193+0.004)
Carrier depth	C	1.45+0.1(0.057+0.004)
Sprocket hole	d	1.55+0.05(0.061+0.002)
Reel outside diameter	D	178+2.0(7.0+0.079)
Reel inner diameter	D1	54±1.0(2.13±0.039)
Feed hole diameter	D2	13+0.5(0.512+0.020)
Strocket hole position	E	1.75+0.1(0.069+0.004)
Punch hole position	F	5.5+0.05(0.217+0.002)
Punch hole pitch	P	4.0+0.1(0.157+0.004)
Sprocket hole pitch	P0	4.0+0.1(0.157+0.004)
Embossment center	P1	2.0+0.1(0.079+0.004)
Totall tape thickness	T	0.23-0.29(0.009-0.011)
Tape width	W	12.0+0.1(0.472+0.004)
Reel width	W1	16.8+2.0(0.661+0.079)

NOTE: Devices are packde in accordance with EIA standard RS-481-A and specification given above.