

DO-27 Plastic-Encapsulate Diodes

Schottky Rectifier Diodes

Features:

- $I_{F(AV)}$ 3A
- V_{RRM} 20V-100V
- High surge current capability
- Polarity: Color band denotes cathode

Application:

- Rectifier

Marking

- SR3XX

X : From 20 To 100

DO-27

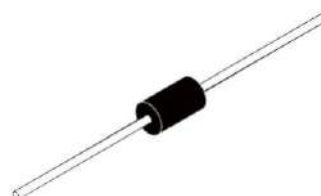

Limiting Values (Absolute Maximum Rating)

Item	Symbol	Unit	Conditions	SR3						
				20	30	40	50	60	80	100
Repetitive Peak Reverse Voltage	V_{RRM}	V		20	30	40	50	60	80	100
Maximum RMS Voltage	V_{RMS}	V		14	21	28	35	42	56	70
Maximum DC Blocking Voltage	V_{DC}	V		20	30	40	50	60	80	100
Average Forward Current	$I_{F(AV)}$	A	60Hz Half-sine wave, Resistance load, TL(Fig.1)	3.0						
Surge(Non-repetitive)Forward Current	I_{FSM}	A	60Hz Half-sine wave, 1 cycle, $T_a=25^\circ\text{C}$	80						
Junction Temperature	T_J	$^\circ\text{C}$		-55 ~ +150						
Storage Temperature	T_{STG}	$^\circ\text{C}$		-55 ~ +150						

Electrical Characteristics (T=25 $^\circ\text{C}$ Unless otherwise specified)

Item	Symbol	Unit	Test Condition	SR3						
				20	30	40	50	60	80	100
Maximum Peak Forward Voltage	V_{FM}	V	$I_{FM}=3.0\text{A}$	0.55		0.65		0.85		
Maximum Peak Reverse	I_{RRM1}	mA	$V_{RM}=V_{RRM}$	$T_a=25^\circ\text{C}$						
	I_{RRM2}			$T_a=125^\circ\text{C}$						
Typical junction capacitance	C_J	pF	Measured at 1MHz and applied reverse voltage of 4.0V D.C.	250			160			
Typical Thermal Resistance	$R_{\theta J-A}$	$^\circ\text{C/W}$	Between junction and ambient	40						
	$R_{\theta J-L}$		Between junction and lead	20						

Notes:

1) Thermal resistance from junction to ambient at 0.375"(9.5mm)lead length,P.C.B. mounted

Typical Characteristics

FIG.1 FORWARD CURRENT DERATING CURVE

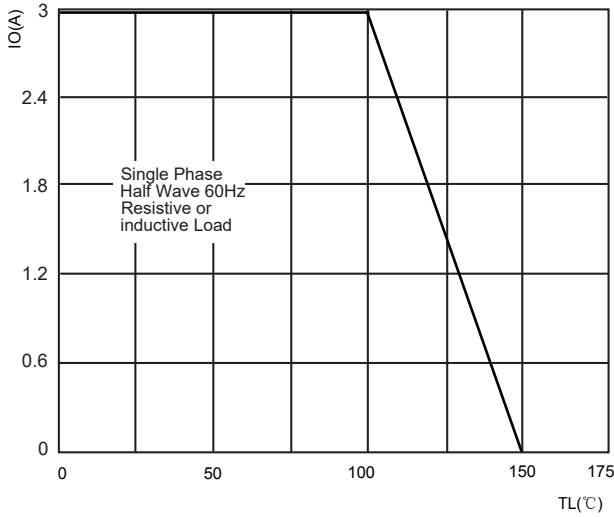

FIG.2: MAXIMUM NON-REPETITIVE FORWARD SURGE CURRENT

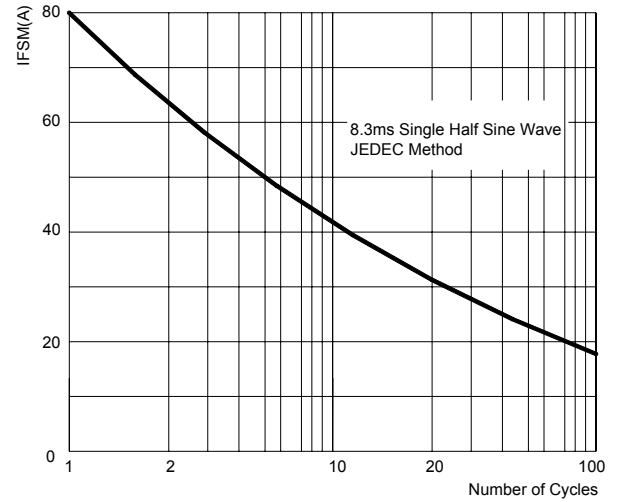

FIG.3: TYPICAL FORWARD CHARACTERISTICS

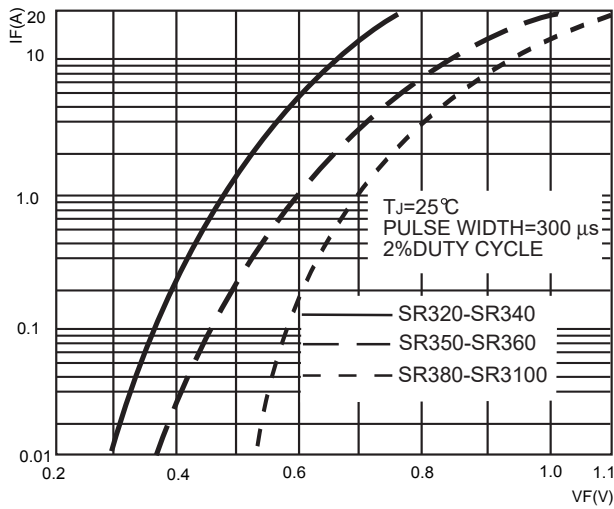
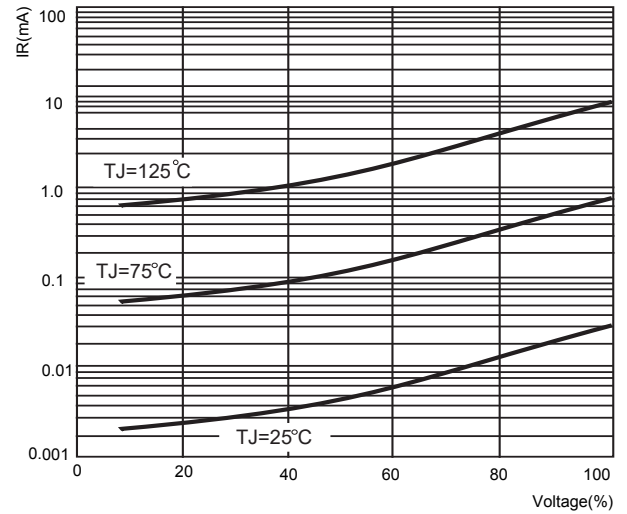
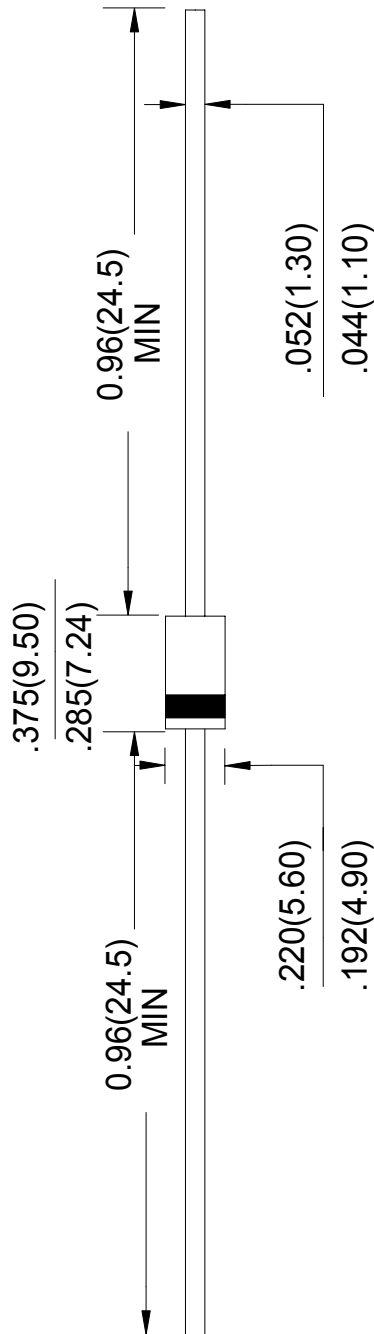

FIG.4: TYPICAL REVERSE CHARACTERISTICS



DO-27 Package Outline Dimensions



Unit: in inches (millimeters)

Axial lead devices are packed in accordance with EIA standard RS-296-D and specifications given below

COMPONENT OUTLINE	COMPONENT PITCH A	INNER TAPE PITCH B	CUMULATIVE PITCH TOLERANCE
	$\pm 0.5\text{mm}(.020'')$	$+0.5\text{mm}(.020'')$	
R-1	5.0mm	26.0mm	2.0mm/20pitch
R-1	5.0mm	52.4mm	2.0mm/10pitch
A-405	5.0mm	26.0mm	2.0mm/20pitch
A-405	5.0mm	52.4mm	2.0mm/10pitch
DO-34/DO-35	5.0mm	26.0mm	2.0mm/20pitch
DO-34/DO-35	5.0mm	52.4mm	2.0mm/10pitch
DO-41	5.0mm	26.0mm	2.0mm/20pitch
DO-41	5.0mm	52.4mm	2.0mm/10pitch
DO-15	5.0mm	52.4mm	2.0mm/10pitch
DO-27	10.0mm	52.4mm	2.0mm/10pitch
R-6	10.0mm	52.4mm	2.0mm/10pitch

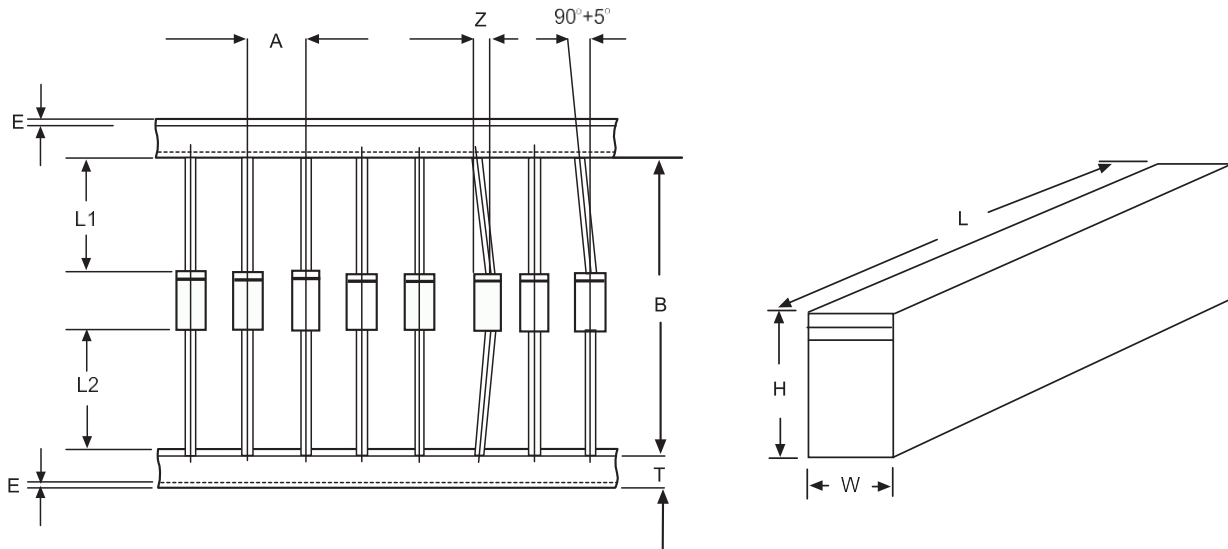

ITEM	SYMBOL	SPECIFICATIONS(mm)	SPECIFICATIONS(inch)
Component alignment	Z	1.2max	0.048max
Tape width	T	6.0±0.4	0.236±0.016
Exposed adhesive	E	0.8max	0.032max
Body eccentricity	IL1-L2I	1.0max	0.040max
Box length	L	255.0±5.0	10.04±0.197
Box width	W	78.0±5.0	3.07±0.197
Box height	H	150.0±5.0	5.91±0.197

NOTE: Each component lead shall be sandwiched between tapes for A minimum of 3.2mm(0.126'')