

DO-27 Plastic-Encapsulate Diodes

Schottky Rectifier Diode

Features:

- $I_{F(AV)}$ 10A
- V_{RRM} 60V
- High surge current capability
- Low peak forward voltage

Applications:

- Rectifier

Marking

- SR1060L

DO-27

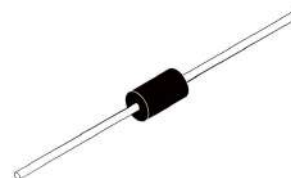

Limiting Values(Absolute Maximum Rating)

Item	Symbol	Unit	Test Conditions	SR1060L
Repetitive Peak Reverse Voltage	V_{RRM}	V		60
Maximum RMS Voltage	V_{RMS}	V		42
Average Forward Current	$I_{F(AV)}$	A	60Hz Half-sine wave, Resistance load, $T_a=125^\circ\text{C}$	10
Surge(Non-repetitive)Forward Current	I_{FSM}	A	60Hz Half-sine wave, 1 cycle, $T_a=25^\circ\text{C}$	280
Junction Temperature	T_J	$^\circ\text{C}$		-55 ~ +150
Storage Temperature	T_{STG}	$^\circ\text{C}$		-55 ~ +150

Electrical Characteristics ($T=25^\circ\text{C}$ Unless otherwise specified)

Item	Symbol	Unit	Test Condition	SR1060L	
Peak Forward Voltage	V_F	V	$I_F=10.0\text{A}$	$T_a=25^\circ\text{C}$	0.50(TYP) 0.55(MAX)
				$T_a=125^\circ\text{C}$	0.43(TYP) 0.47(MAX)
Peak Reverse Current	I_{RRM1}	mA	$V_{RM}=V_{RRM}$	$T_a=25^\circ\text{C}$	0.08(TYP) 0.30(MAX)
	I_{RRM2}			$T_a=125^\circ\text{C}$	35(TYP) 40(MAX)
Thermal Resistance(Typical)	$R_{\theta J-A}$	$^\circ\text{C}/\text{W}$	Between junction and ambient	80	
	$R_{\theta J-L}$		Between junction and terminal	25	
Typical junction capacitance	C_J	nF	$V_R=4.0\text{V}$, $f=1\text{MHz}$	0.95	

Notes:

Thermal resistance from junction to ambient and from junction to lead mounted on P.C.B. with 0.3" x 0.3" (8.0 mm x 8.0 mm) copper pad areas

Typical Characteristics

FIG.1: FORWARD CURRENT DERATING CURVE

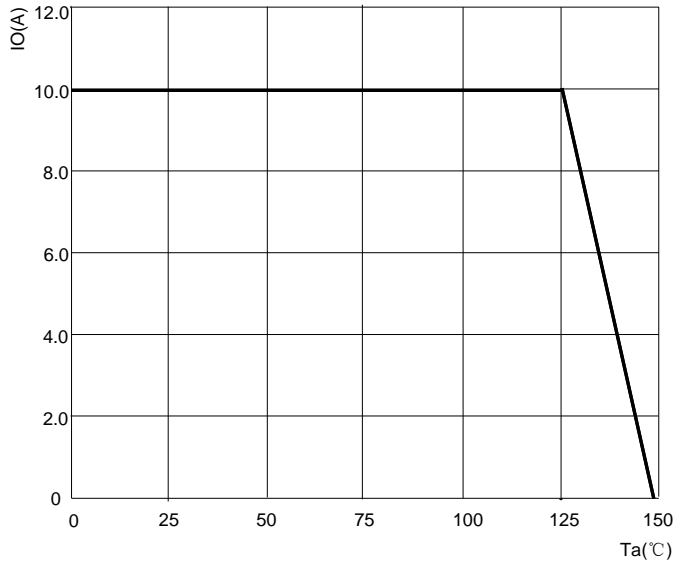

FIG.2: MAXIMUM NON-REPETITIVE FORWARD SURGE CURRENT

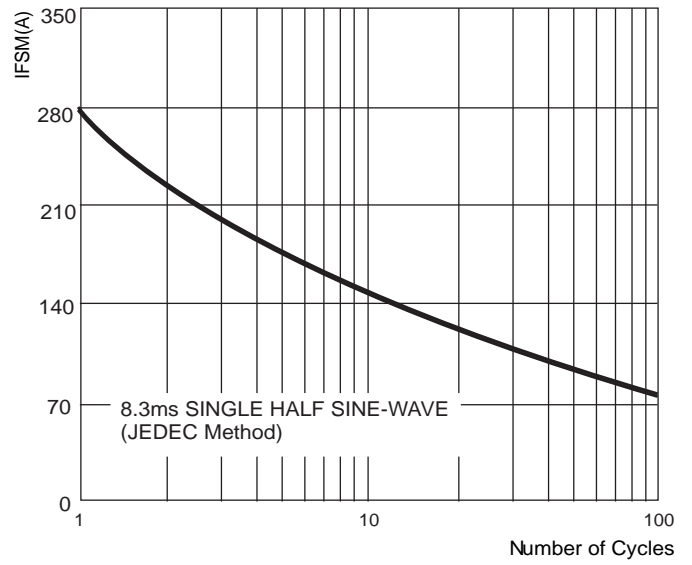

FIG.3: INSTANTANEOUS FORWARD CHARACTERISTICS

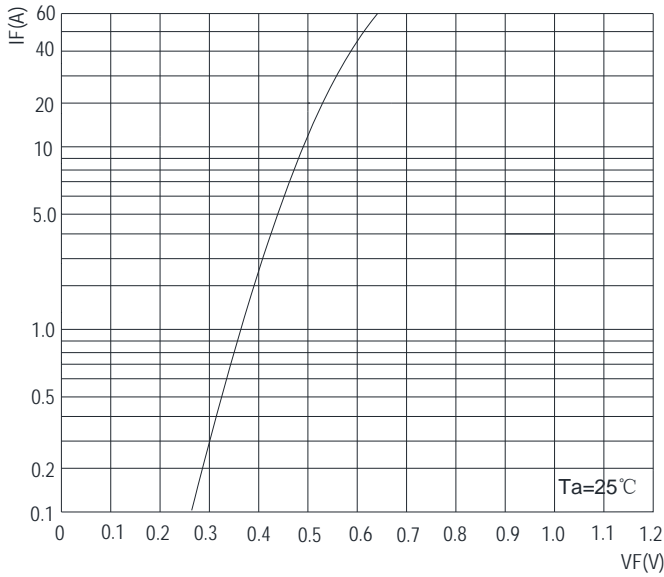
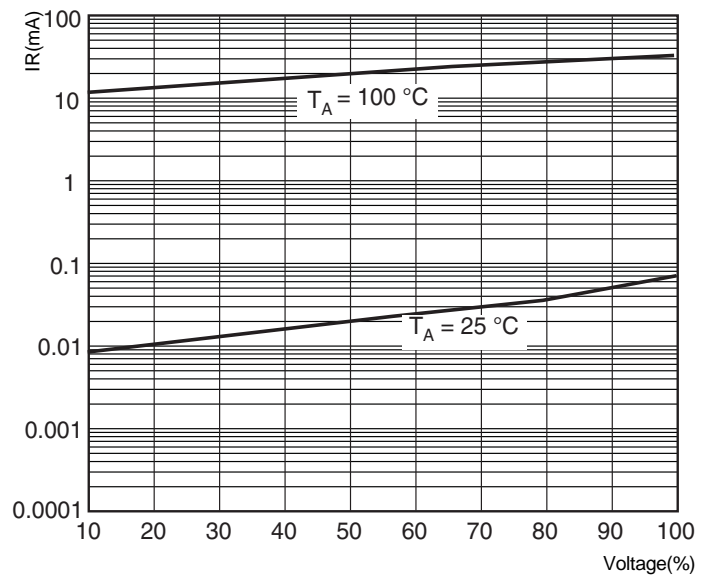
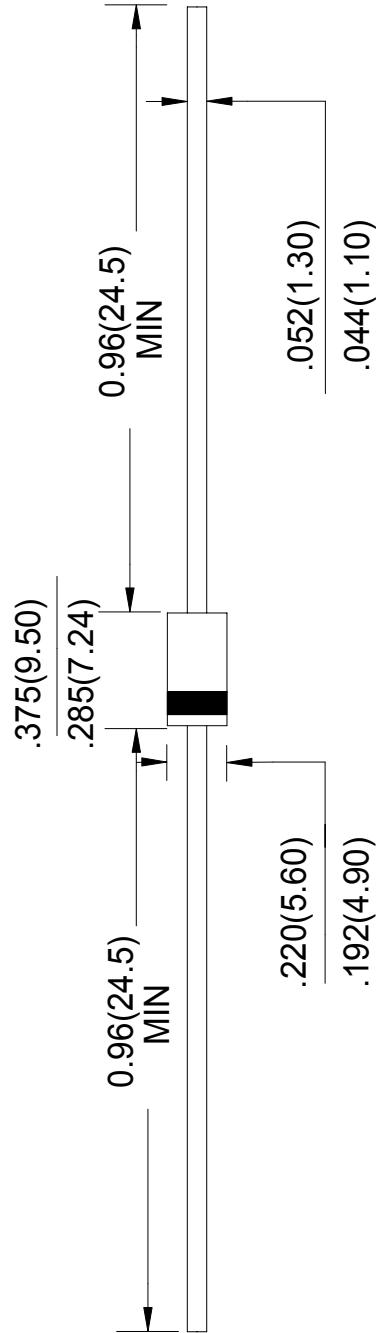

FIG.4: TYPICAL REVERSE CHARACTERISTICS



DO-27 Package Outline Dimensions



Unit: in inches (millimeters)

Ammo Box Packaging Specifications For Axial Lead Rectifiers

Axial lead devices are packed in accordance with EIA standard RS-296-D and specifications given below

COMPONENT OUTLINE	COMPONENT PITCH A	INNER TAPE PITCH B	CUMULATIVE PITCH TOLERANCE
	$\pm 0.5\text{mm}(0.020\text{'})$	$+0.5\text{mm}(0.020\text{'})$	
R-1	5.0mm	26.0mm	2.0mm/20pitch
R-1	5.0mm	52.4mm	2.0mm/10pitch
A-405	5.0mm	26.0mm	2.0mm/20pitch
A-405	5.0mm	52.4mm	2.0mm/10pitch
DO-34/DO-35	5.0mm	26.0mm	2.0mm/20pitch
DO-34/DO-35	5.0mm	52.4mm	2.0mm/10pitch
DO-41	5.0mm	26.0mm	2.0mm/20pitch
DO-41	5.0mm	52.4mm	2.0mm/10pitch
DO-15	5.0mm	52.4mm	2.0mm/10pitch
DO-27	10.0mm	52.4mm	2.0mm/10pitch
R-6	10.0mm	52.4mm	2.0mm/10pitch

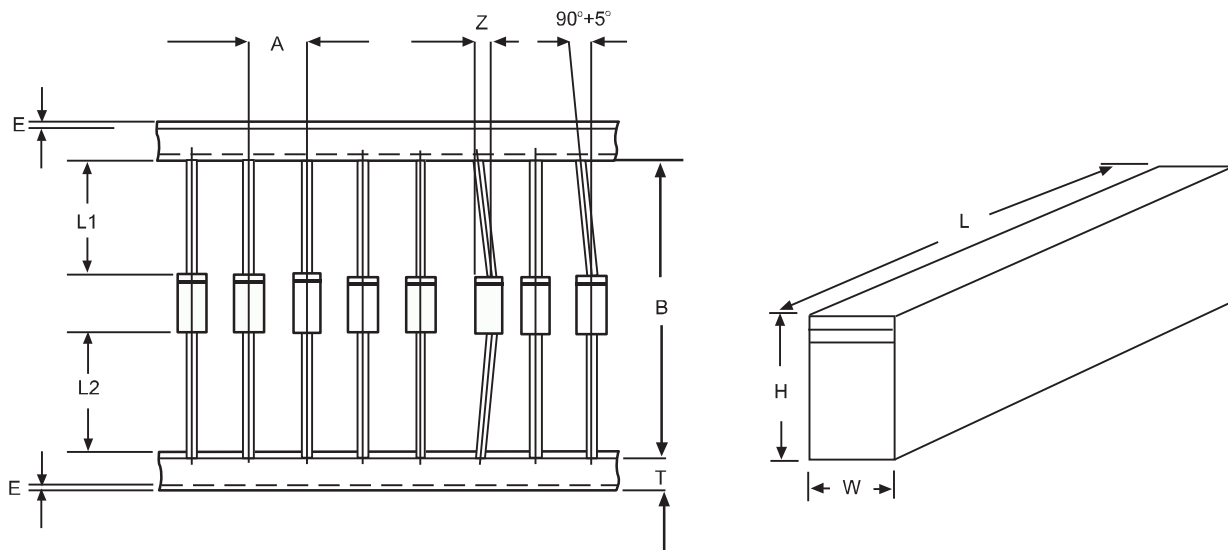

ITEM	SYMBOL	SPECIFICATIONS(mm)	SPECIFICATIONS(inch)
Component alignment	Z	1.2max	0.048max
Tape width	T	6.0 \pm 0.4	0.236 \pm 0.016
Exposed adhesive	E	0.8max	0.032max
Body eccentricity	L1-L2	1.0max	0.040max
Box length	L	255.0 \pm 5.0	10.04 \pm 0.197
Box width	W	78.0 \pm 5.0	3.07 \pm 0.197
Box height	H	150.0 \pm 5.0	5.91 \pm 0.197

NOTE: Each component lead shall be sandwiched between tapes for A minimum of 3.2mm(0.126'')