

Silicon Carbide Schottk Diode 650V, 10A, 23nC

This product family offers state of the art performance. It is designed for high frequency applications here high efficiency and high reliability are required.

Features:

- Zero Forward/Reverse Recovery Current
- High Blocking Voltage
- High Frequency Operation
- Positive Temperature Coefficient on VF
- Temperature Independent Switching Behavior

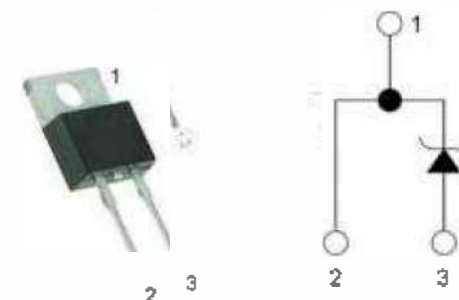

Applications:

- Motor Drives
- Solar
- AC/DC converters
- DC/DC converters
- Uninterruptable power supplies

TO-220-2
Pin definition

Benefits:

- Higher System Efficiency
- Parallel Device Convenience without thermal runaway
- Higher Temperature Application
- No Switching loss
- Hard Switching & Higher Reliability
- Environmental Protection

Key performance parameters

Type	V_R	I_F $T_C=150^\circ\text{C}$	Q_C
KW10PS065C	650V	10A	23nC

Maximum Ratings

$T_C=25^{\circ}\text{C}$, unless otherwise specified

Parameter	Symbol	Value	Unit
Peak Repetitive Reverse Voltage	V_{RRM}	650	V
Peak Reverse Surge Voltage	V_{RSM}	650	V
DC Blocking Voltage	V_R	650	V

Maximum Ratings

$T_C=25^{\circ}\text{C}$, unless otherwise specified

Parameter	Symbol	Value	Unit				
Continuous Forward Current: $T_C = 25^{\circ}\text{C}$ $T_C = 135^{\circ}\text{C}$ $T_C = 155^{\circ}\text{C}$	I_F	32 14 10	A				
Non Repetitive Forward Surge Current: $T_C = 25^{\circ}\text{C}$, $t_p = 10\text{ms}$, Half Sine Pulse $T_C = 150^{\circ}\text{C}$, $t_p = 10\text{ms}$, Half Sine Pulse $T_C = 25^{\circ}\text{C}$, $t_p = 10 \mu\text{s}$, Square		I_{FSM}		65 55 520	A		
Repetitive peak Forward Surge Current: Freq = 0.1Hz, 100 cycles $T_C = 25^{\circ}\text{C}$, $t_p = 10\text{ms}$, Half Sine Pulse $T_C = 150^{\circ}\text{C}$, $t_p = 10\text{ms}$, Half Sine Pulse				I_{FRM}		55 45	A
Total power dissipation: $T_C = 25^{\circ}\text{C}$						P_D	
Operating Junction Temperature :	T_j	-55 to 175	$^{\circ}\text{C}$				
Storage Temperature :	T_{stg}	-55 to 175	$^{\circ}\text{C}$				

Thermal Resistance

Parameter	Symbol	Typ.	Max	Unit
Thermal resistance, junction-case	R_{thJC}	1.6		°C/W

Electrical Characteristic

$T_C = 25^\circ\text{C}$, unless otherwise specified

Parameter	Symbol	Value			Unit	Test Condition
		Min.	Typ.	Max.		
DC Blocking Voltage	V_{DC}	650			V	$I_R = 250\mu\text{A}$ $T_J = 25^\circ\text{C}$
Forward Voltage	V_F		1.45 1.6 1.7	1.8	V	$I_F = 10\text{A}$ $T_J = 25^\circ\text{C}$ $T_J = 125^\circ\text{C}$ $T_J = 175^\circ\text{C}$
Reverse Current	I_R		12 68 190	80	μA	$V_R = 650\text{V}$ $T_J = 25^\circ\text{C}$ $T_J = 125^\circ\text{C}$ $T_J = 175^\circ\text{C}$
Total Capacitance Charge	Q_C		23		nC	$V_R = 400\text{V}$ $T_J = 25^\circ\text{C}$
Total Capacitance	C		380 48 31		pF	$V_R = 1\text{V}$ $V_R = 200\text{V}$ $V_R = 400\text{V}$ $T_J = 25^\circ\text{C}$ Freq = 1MHz

Characteristics Curves

Figure 1. Forward Characteristics

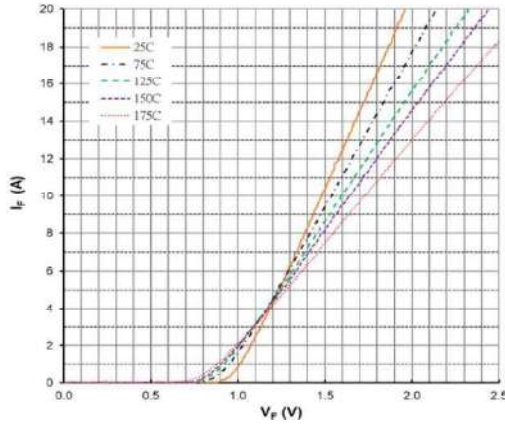

Figure 2. Forward Characteristics

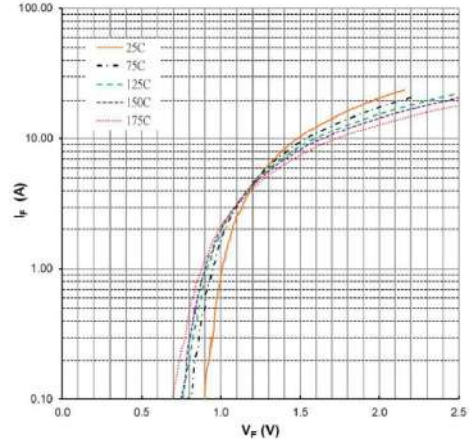

Figure 3. Reverse Characteristics

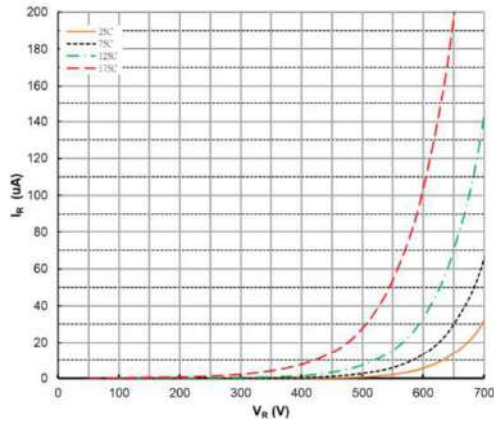

Figure 4. Power Derating

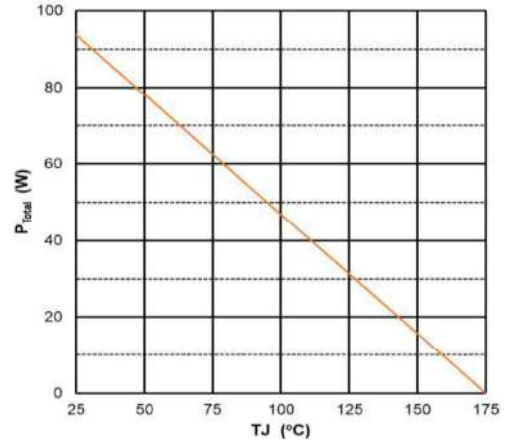

Figure 5. Capacitance vs Reverse Voltage

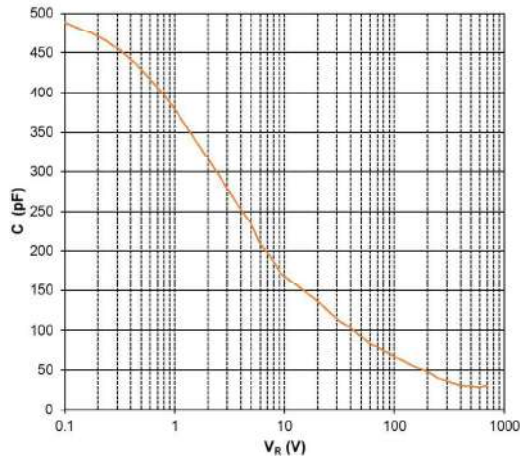
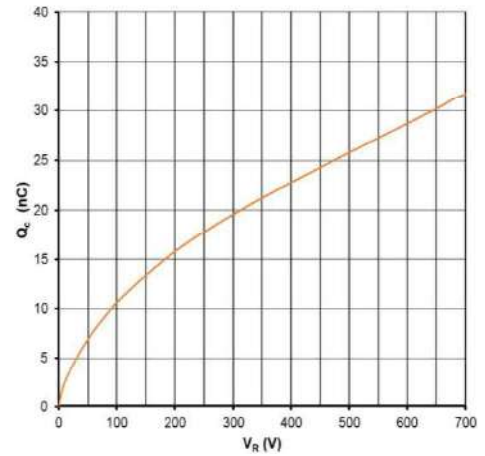
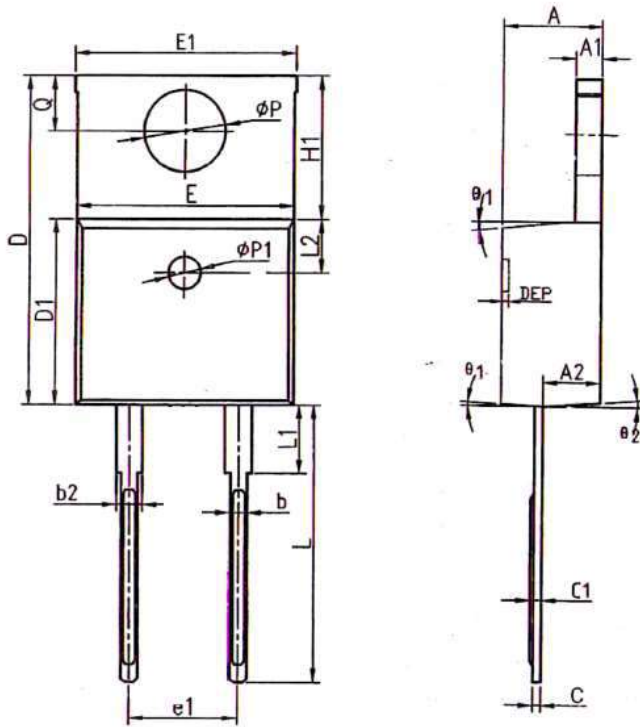

Figure 6. Recovery Charge vs Reverse Voltage



Package Dimensions

(TO-220-2 Package)



COMMON DIMENSIONS

SYMBOL	MM			INCH		
	MIN	NOM	MAX	MIN	NOM	MAX
A	4.40	4.57	4.70	0.173	0.180	0.185
A1	1.22	1.27	1.32	0.048	0.050	0.052
A2	2.59	2.69	2.79	0.102	0.106	0.110
b	0.77	0.813	0.90	0.030	0.032	0.035
b2	1.20	1.27	1.36	0.047	0.050	0.054
c	0.34	0.381	0.47	0.013	0.015	0.019
c1	0.40	0.559	0.60	0.016	0.022	0.024
D	14.70	15.00	15.30	0.579	0.591	0.602
D1	8.60	8.70	8.80	0.339	0.343	0.346
E	10.06	10.16	10.26	0.396	0.400	0.404
E1	10.10	10.25	10.35	0.398	0.404	0.407
E2	10.00	10.10	10.20	0.394	0.398	0.402
e	2.54 BSC			0.100 BSC		
e1	5.08 BSC			0.200 BSC		
H1	6.10	6.30	6.50	0.240	0.248	0.256
L	13.20	13.40	13.50	0.520	0.528	0.531
L1	-	3.75	4.00	-	0.148	0.157
L2	2.50 REF			0.098 REF		
ϕP	3.76	3.84	3.88	0.148	0.151	0.153
Q	2.60	2.743	2.90	0.102	0.108	0.114
$\theta 1$	5°	7°	9°	5°	7°	9°
$\theta 2$	1°	3°	5°	1°	3°	5°
$\phi P1$	1.40	1.50	1.60	0.055	0.059	0.063
DEP	0.05	0.10	0.20	0.002	0.004	0.008

Part Number	Package	Packing	Marking	M.O.Q
KW10PS065C	TO-220-2	50pcs / Tube	10PS065C	500

