

SOT-323 Plastic-Encapsulate Diodes

SOT-323

SCHOTTKY BARRIER DIODE

Features:

- Low Turn-on Voltage
- Extremely Fast Switching Speed
- PN Junction Guard Ring for Transient and ESD Protection
- Totally Lead-Free & Fully RoHS Compliant
- Halogen and Antimony Free. "Green" Device

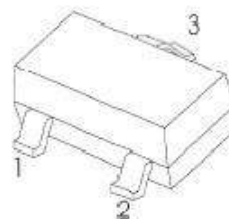



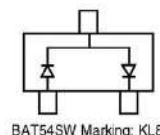
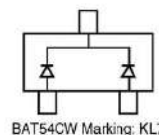
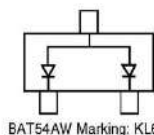
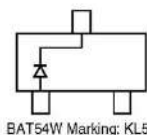

Description:

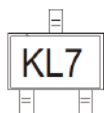

These Schottky Barrier Diodes are Designed for High Speed Switching Applications, Circuit Protection, And Voltage Clamping. Extremely Low Forward Voltage Reduces Conduction Loss. Miniature Surface Mount Package is Excellent For Handheld And Portable Applications Where Space is Limited.

MARKING:

BAT54W	BAT54AW	BAT54CW	BAT54SW
			

MAXIMUM RATINGS (T_a=25°C unless otherwise noted)

Parameter	Symbol	Value	Unit
Peak Repetitive Reverse Voltage	V _{RRM}	30	V
Working Peak Reverse Voltage	V _{RWM}		
DC Blocking Voltage	V _R		
Forward Continuous Current	I _{FM}	200	mA
Non-repetitive Peak Forward Surge Current @ t=8.3ms	I _{FSM}	600	mA
Repetitive Peak Forward Current @ t≤1s, δ ≤0.5	I _{FRM}	300	mA
Power Dissipation	P _D	200	mW
Thermal Resistance from Junction to Ambient	R _{θJA}	500	°C/W
Junction Temperature	T _j	125	°C
Storage Temperature	T _{stg}	-55~+150	°C

ELECTRICAL CHARACTERISTICS(T_a=25°C unless otherwise specified)

Parameter	Symbol	Test conditions	Min	Typ	Max	Unit
Reverse voltage	V _(BR)	I _R =100μA	30			V
Reverse current	I _R	V _R =25V			2	μA
Forward voltage	V _F	I _{F1} =0.1mA			0.24	V
		I _{F2} =1mA			0.32	V
		I _{F3} =10mA			0.40	V
		I _{F4} =30mA			0.50	V
		I _{F5} =100mA			1	V
Diode capacitance	C _D	V _R =1V, f=1MHz			10	pF
Reverse recovery time	t _{rr}	I _F =I _R =10mA I _{rr} =0.1×I _R , R _L =100Ω			5	ns

Typical Characteristics

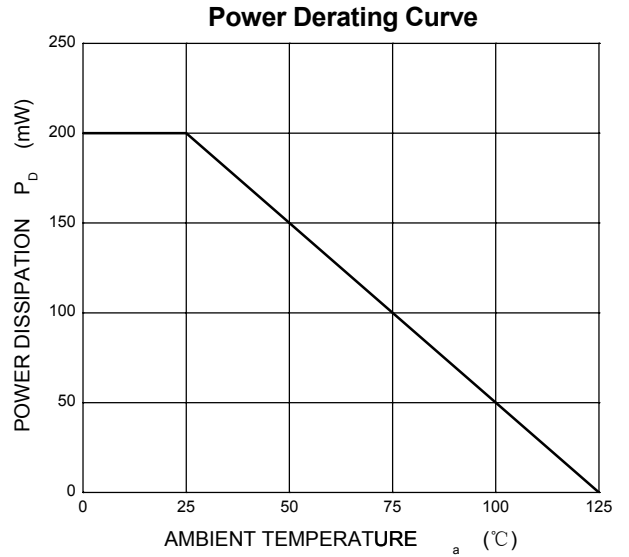
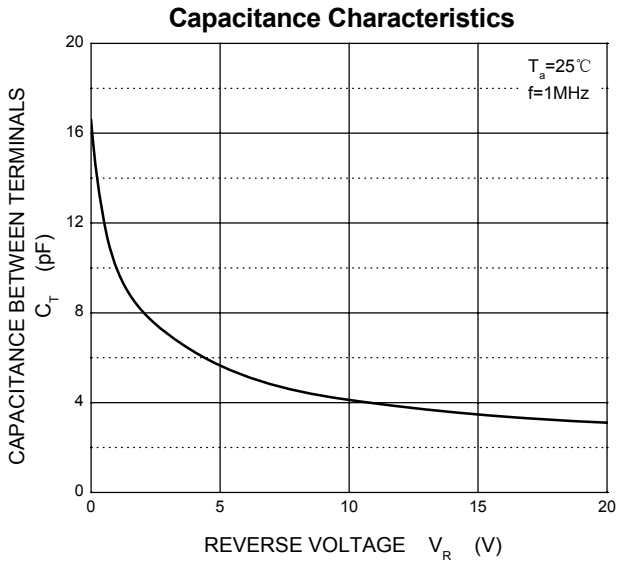
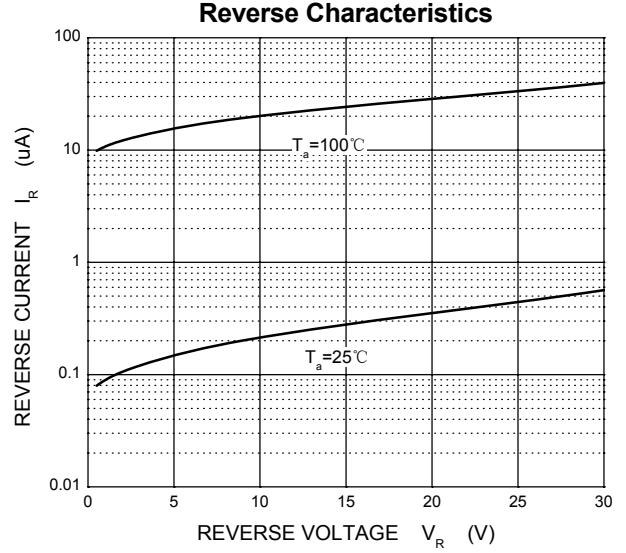
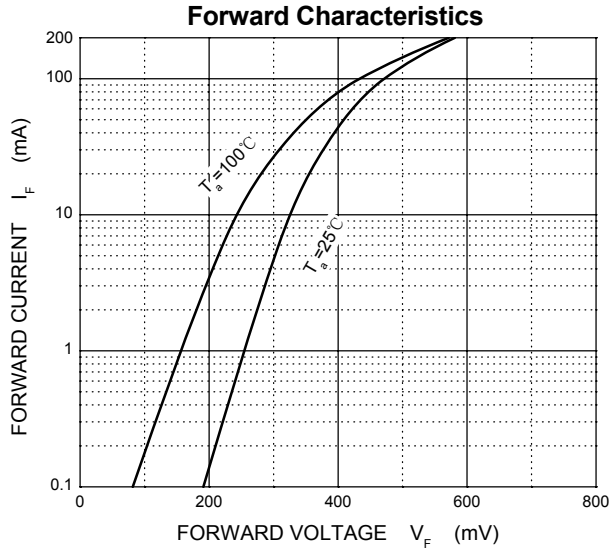

SOT-323 Package Outline Dimensions

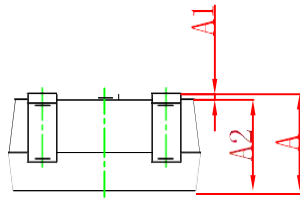
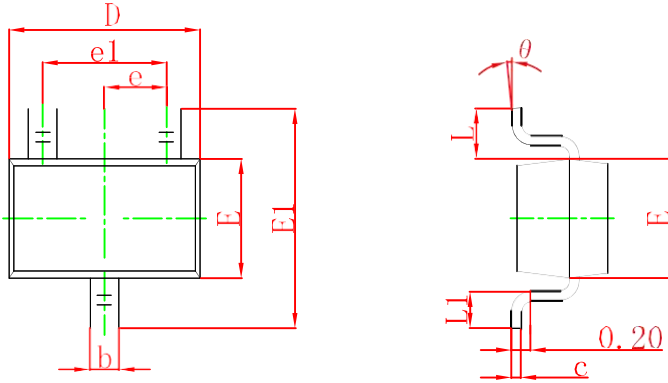

Symbol	Dimensions In Millimeters		Dimensions In Inches	
	Min	Max	Min	Max
A	0.900	1.100	0.035	0.043
A1	0.000	0.100	0.000	0.004
A2	0.900	1.000	0.035	0.039
b	0.200	0.400	0.008	0.016
c	0.080	0.150	0.003	0.006
D	2.000	2.200	0.079	0.087
E	1.150	1.350	0.045	0.053
E1	2.150	2.450	0.085	0.096
e	0.650 TYP		0.026 TYP	
e1	1.200	1.400	0.047	0.055
L	0.525 REF		0.021 REF	
L1	0.260	0.460	0.010	0.018
θ	0°	8°	0°	8°

SOT-323 Suggested Pad Layout

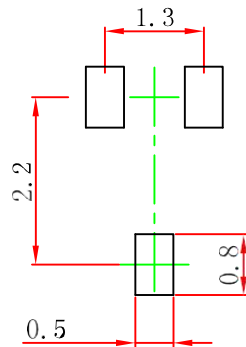

Note:

1. Controlling dimension: In millimeters.
2. General tolerance: ± 0.05 mm.
3. The pad layout is for reference purposes only.

SOT-323 Tape and Reel

SOT-323 Embossed Carrier Tape

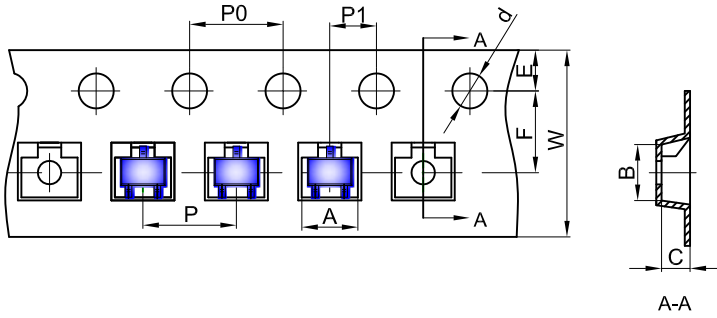

Packaging Description:

SOT-323 parts are shipped in tape. The carrier tape is made from a dissipative (carbon filled) polycarbonate resin. The cover tape is a multilayer film (Heat Activated Adhesive in nature) primarily composed of polyester film, adhesive layer, sealant, and anti-static sprayed agent. These reeled parts in standard option are shipped with 3,000 units per 7" or 17.8cm diameter reel. The reels are clear in color and is made of polystyrene plastic (anti-static coated).

Dimensions are in millimeter										
Pkg type	A	B	C	d	E	F	P0	P	P1	W
SOT-323	2.25	2.55	1.19	Ø1.55	1.75	3.50	4.00	4.00	2.00	8.00

SOT-323 Tape Leader and Trailer

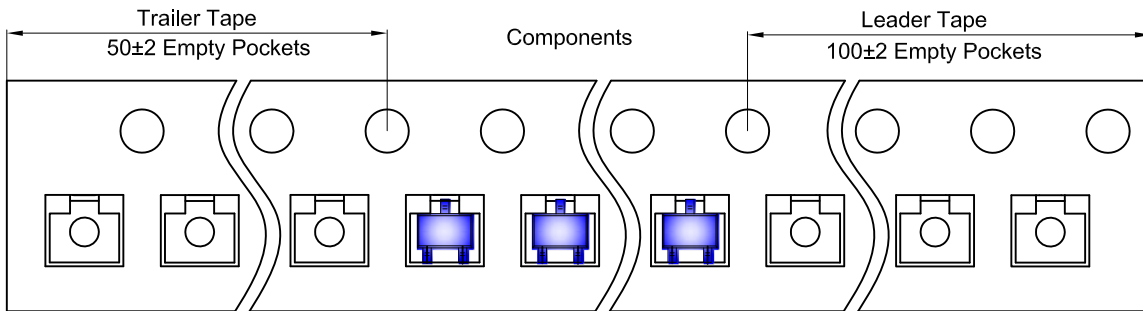

SOT-323 Reel

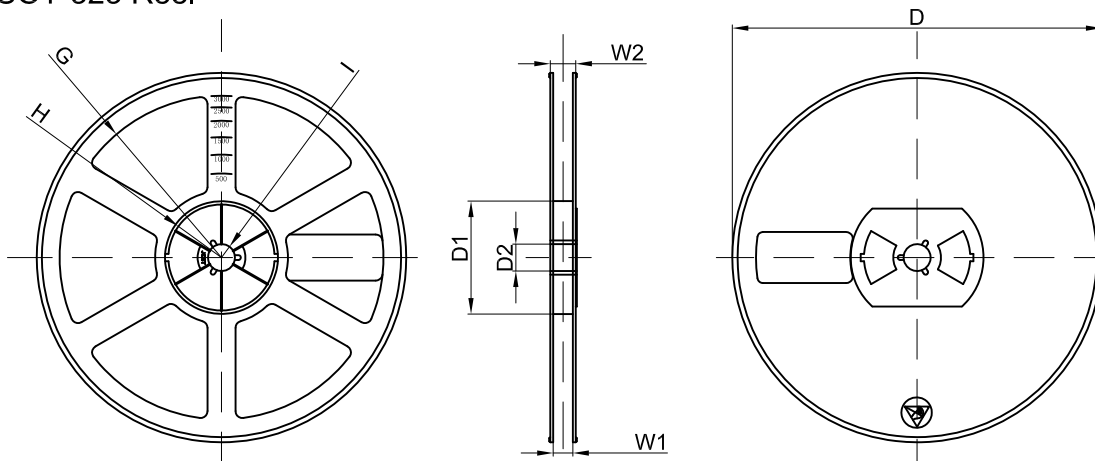

Dimensions are in millimeter								
Reel Option	D	D1	D2	G	H	I	W1	W2
7" Dia	Ø178.00	54.40	13.00	R78.00	R25.60	R6.50	9.50	12.30

REEL	Reel Size	Box	Box Size(mm)	Carton	Carton Size(mm)	G.W.(kg)
3000 pcs	7 inch	45,000 pcs	203×203×195	180,000 pcs	438×438×220	