

SOD-323 Plastic-Encapsulate Diodes

Features:

- Low Forward Voltage Drop
- Very Small SMD Package

Applications:

- Low Voltage Rectification
- High Efficiency DC/DC Conversion
- Switch Mode Power Supply
- Inverse Polarity Protection
- Low Power Consumption Applications

SOD-323

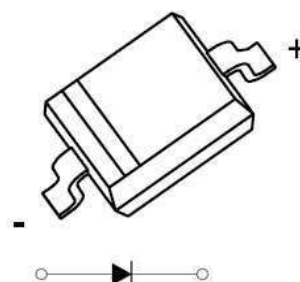

MARKING: S4



MAXIMUM RATINGS ($T_a=25^{\circ}\text{C}$ unless otherwise noted)

Symbol	Parameter	Value	Unit
V_{RRM}	Peak Repetitive Reverse Voltage	40	V
V_{RWM}	Working Peak Reverse Voltage		
$V_{R(RMS)}$	RMS Reverse Voltage	28	V
I_O	Average Rectified Output Current	1	A
I_{FSM}	Non-repetitive Peak Forward Surge Current @ $t=8.3\text{ms}$	20	A
P_D	Power Dissipation	250	mW
$R_{\theta JA}$	Thermal Resistance from Junction to Ambient	400	$^{\circ}\text{C/W}$
T_j	Junction Temperature	125	$^{\circ}\text{C}$
T_{stg}	Storage Temperature	-55~+150	$^{\circ}\text{C}$

ELECTRICAL CHARACTERISTICS($T_a=25^{\circ}\text{C}$ unless otherwise specified)

Parameter	Symbol	Test conditions	Min	Typ	Max	Unit
Reverse breakdown voltage	$V_{(BR)}$	$I_R=1\text{mA}$	40			V
Reverse current	I_R	$V_R=20\text{V}$			50	μA
Forward voltage	V_F	$I_F=0.5\text{A}$			0.51	V
		$I_F=0.7\text{A}$			0.55	
Total capacitance	C_{tot}	$V_R=10\text{V}, f=1\text{MHz}$			20	pF

Typical Characteristics

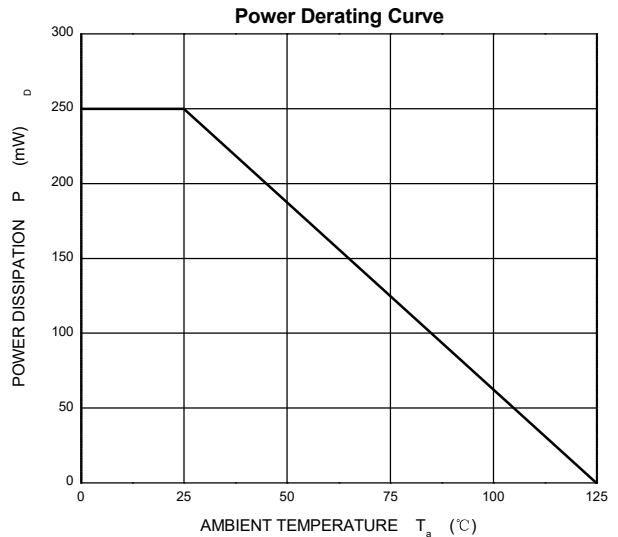
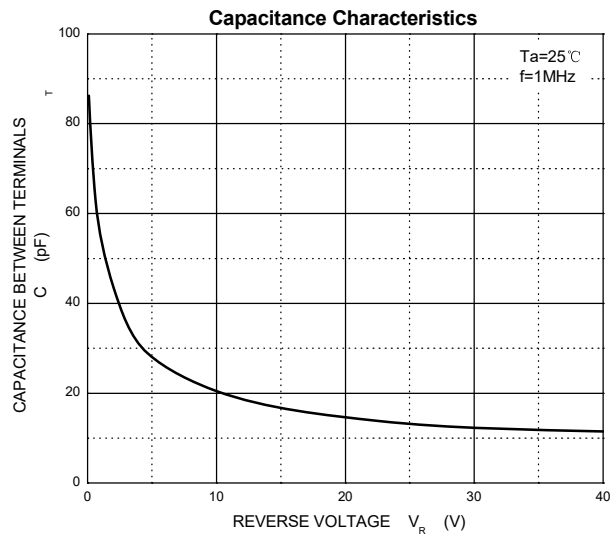
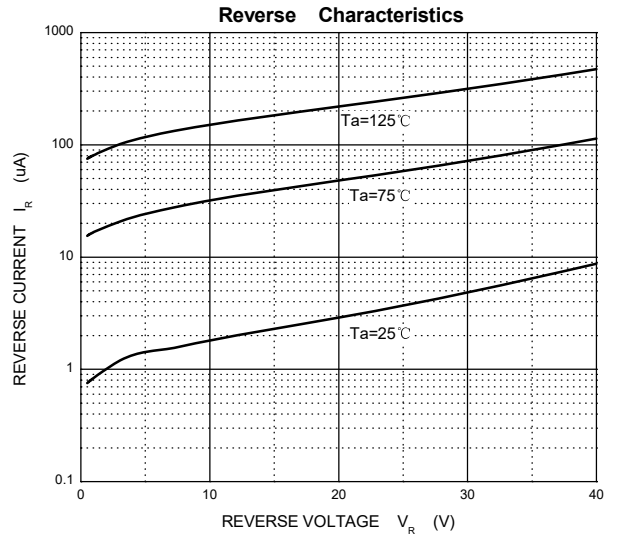
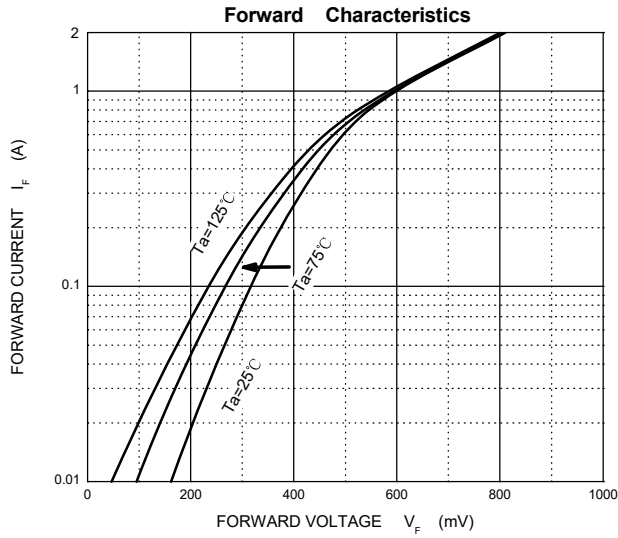

SOD-323 Package Outline Dimensions

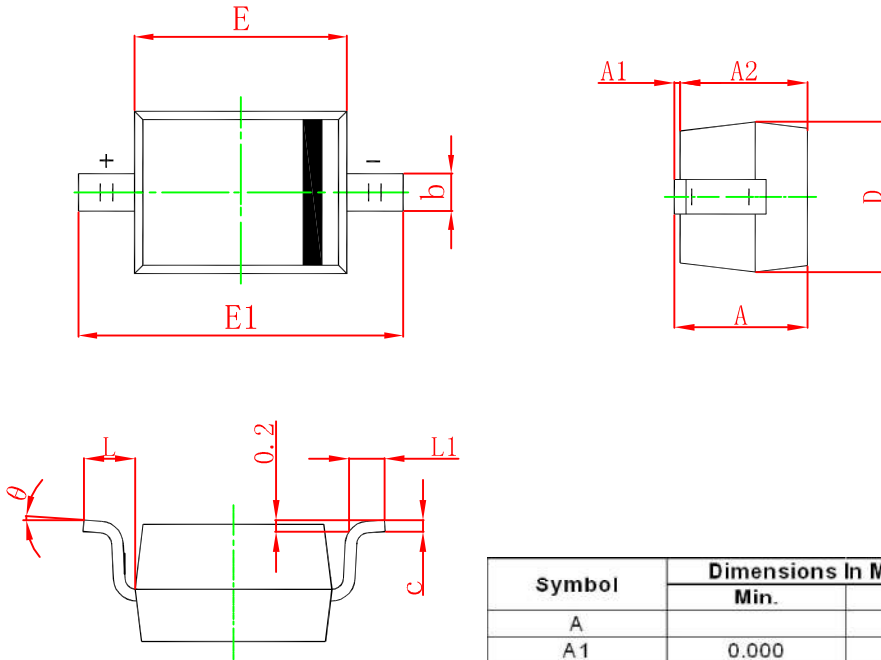

Symbol	Dimensions In Millimeters		Dimensions In Inches	
	Min.	Max.	Min.	Max.
A		1.000		0.039
A1	0.000	0.100	0.000	0.004
A2	0.800	0.900	0.031	0.035
b	0.250	0.350	0.010	0.014
c	0.080	0.150	0.003	0.006
D	1.200	1.400	0.047	0.055
E	1.600	1.800	0.063	0.071
E1	2.550	2.750	0.100	0.108
L	0.475 REF.		0.019 REF.	
L1	0.250	0.400	0.010	0.016
θ	0°		8°	

SOD-323 Suggested Pad Layout

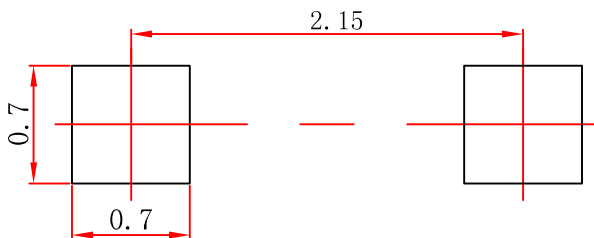

Note:

1. Controlling dimension: in millimeters.
2. General tolerance: ± 0.05 mm.
3. The pad layout is for reference purposes only.

SOD-323 Tape and Reel

SOD-323 Embossed Carrier Tape

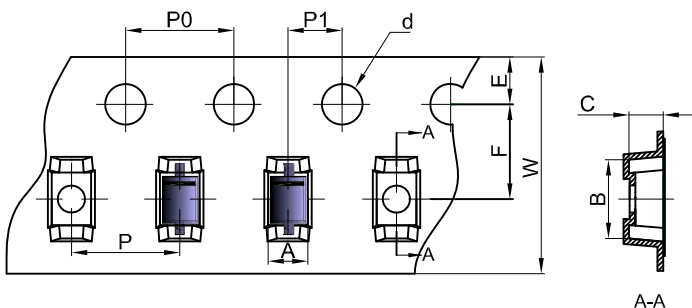

Packaging Description:

SOD-323 parts are shipped in tape. The carrier tape is made from a dissipative (carbon filled) polycarbonate resin. The cover tape is a multilayer film (Heat Activated Adhesive in nature) primarily composed of polyester film, adhesive layer, sealant, and anti-static sprayed agent. These reeled parts in standard option are shipped with 3,000 units per 7" or 17.8cm diameter reel. The reels are clear in color and is made of polystyrene plastic (anti-static coated).

Dimensions are in millimeter										
Pkg type	A	B	C	d	E	F	P0	P	P1	W
SOD-323	1.48	3.3	1.25	Ø1.50	1.75	3.50	4.00	4.00	2.00	8.00

SOD-323 Tape Leader and Trailer

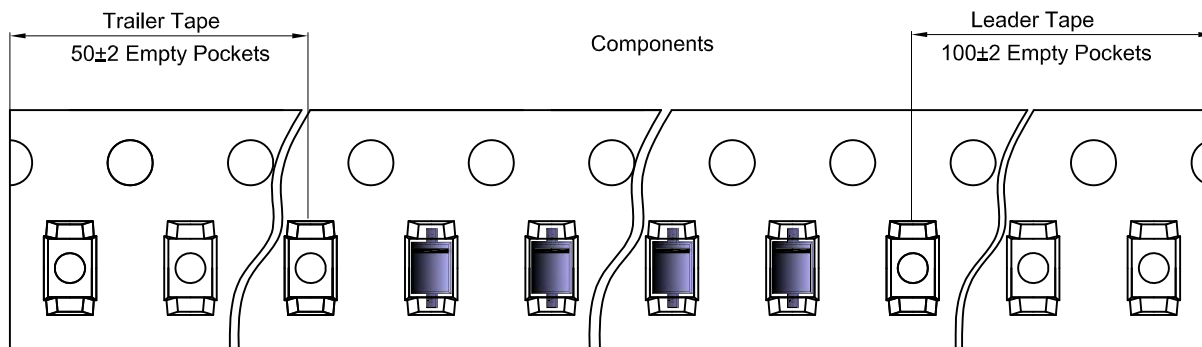

SOD-323 Reel

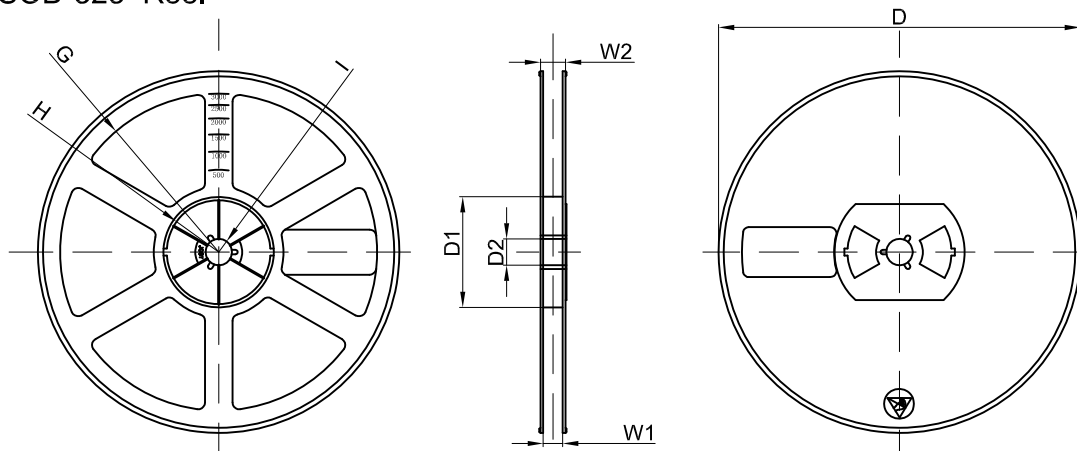

Dimensions are in millimeter								
Reel Option	D	D1	D2	G	H	I	W1	W2
7"Dia	Ø178.00	54.40	13.00	R78.00	R25.60	R6.50	9.50	12.30

REEL	Reel Size	Box	Box Size(mm)	Carton	Carton Size(mm)	G.W.(kg)
3000 pcs	7 inch	45,000 pcs	203×203×195	180,000 pcs	438×438×220	