

SOD-123 Plastic-Encapsulate Diodes

SCHOTTKY BARRIER DIODE

SOD-123

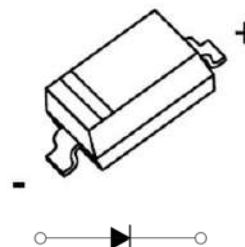

Features:

- Low Forward Voltage Drop
- Guard Ring Construction for Transient Protection
- High Conductance
- Also Available in Lead Free Version

MARKING:SE



Maximum Ratings @Ta=25°C

Parameter	Symbo	Value	Unit
Peak repetitive peak reverse voltage	V_{RRM}	30	V
Working peak reverse voltage	V_{RWM}		
DC blocking voltage	V_R		
RMS reverse voltage reverse voltage (DC)	$V_{R(RMS)}$	21	V
Average rectified output current	I_o	0.5	A
Non-repetitive Peak Forward Surge Current @t=8.3ms	I_{FSM}	5.5	A
Power dissipation	P_D	500	mW
Thermal resistance junction to ambient	$R_{\theta JA}$	200	°C/W
Junction temperature	T_j	125	°C
Storage temperature	T_{STG}	-55~+150	°C
Voltage rate of change	dv/dt	1000	V/μs

Electrical Characteristics @Ta=25°C

	Symbol	Test conditions	Min	Typ	Max	Unit
Reverse breakdown voltage	$V_{(BR)}$	$I_R=200\mu A$	30			V
Reverse current	I_R	$V_R=15V$			20	μA
		$V_R=30V$			130	
Forward voltage	V_F	$I_F=0.1A$			0.375	V
		$I_F=0.5A$			0.430	
Capacitance between terminals	C_T	$V_R=1, f=1MHz$		170		pF

Typical Characteristics

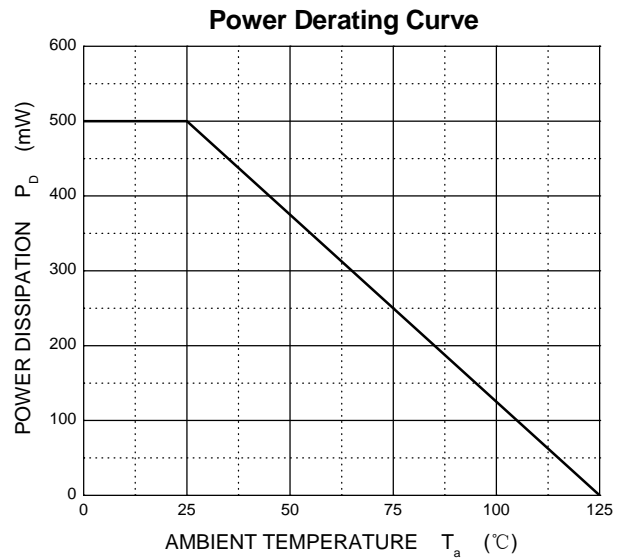
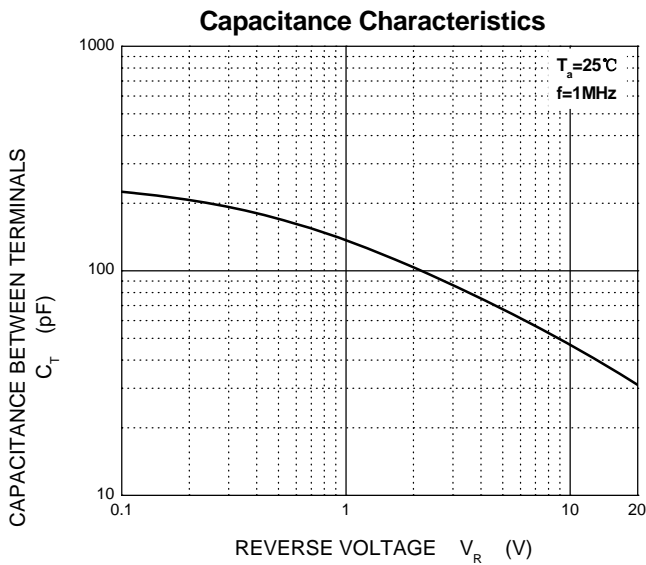
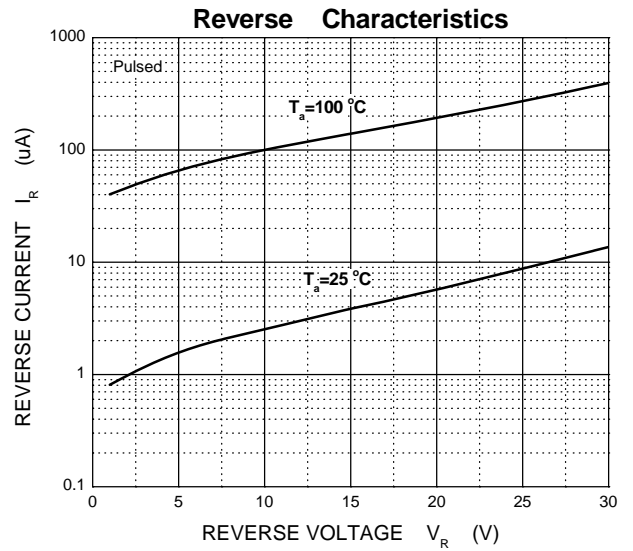
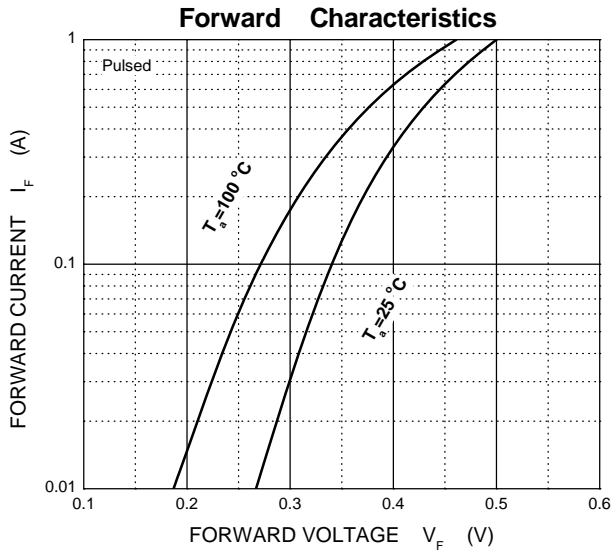

SOD-123 Package Outline Dimensions

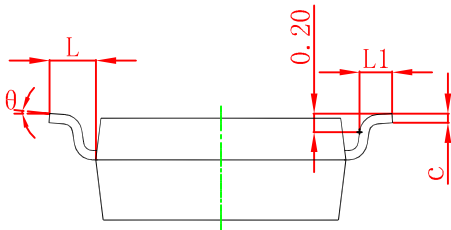
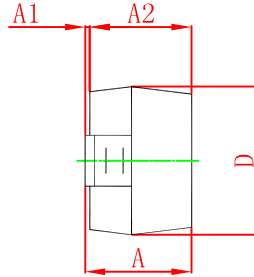
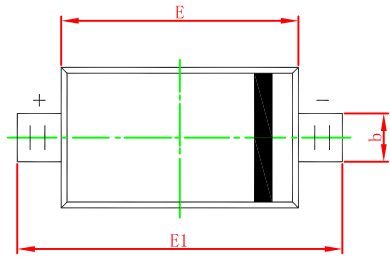

Symbol	Dimensions In Millimeters		Dimensions In Inches	
	Min	Max	Min	Max
A	1.050	1.250	0.041	0.049
A1	0.000	0.100	0.000	0.004
A2	1.050	1.150	0.041	0.045
b	0.450	0.650	0.018	0.026
c	0.080	0.150	0.003	0.006
D	1.500	1.700	0.059	0.067
E	2.600	2.800	0.102	0.110
E1	3.550	3.850	0.140	0.152
L	0.500 REF		0.020 REF	
L1	0.250	0.450	0.010	0.018
θ	0°	8°	0°	8°

SOD-123 Suggested Pad Layout

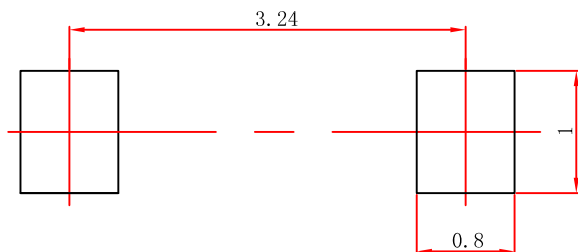

Note:

1. Controlling dimension: in millimeters.
2. General tolerance: $\pm 0.05\text{mm}$.
3. The pad layout is for reference purposes only.

SOD-123 Tape and Reel

SOD-123 Embossed Carrier Tape

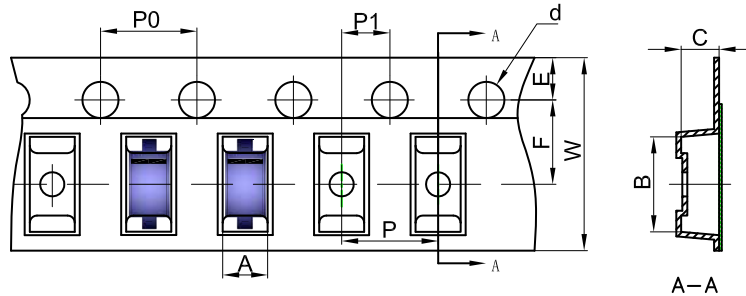

Packaging Description:

SOD-123 parts are shipped in tape. The carrier tape is made from a dissipative (carbon filled) polycarbonate resin. The cover tape is a multilayer film (Heat Activated Adhesive in nature) primarily composed of polyester film, adhesive layer, sealant, and anti-static sprayed agent. These reeled parts in standard option are shipped with 3,000 units per 7" or 17.8cm diameter reel. The reels are clear in color and is made of polystyrene plastic (anti-static coated).

Dimensions are in millimeter										
Pkg type	A	B	C	d	E	F	P0	P	P1	W
SOD-123	1.85	3.95	1.57	Ø1.55	1.75	3.50	4.00	4.00	2.00	8.00

SOD-123 Tape Leader and Trailer

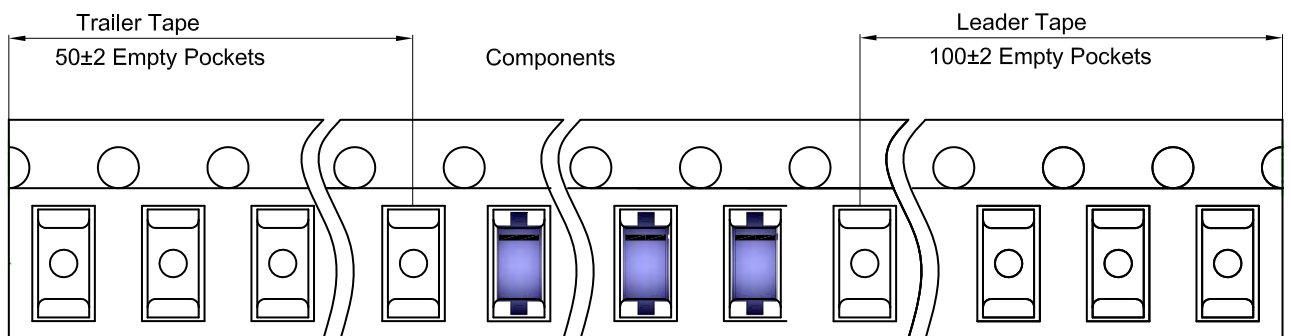

SOD-123 Reel

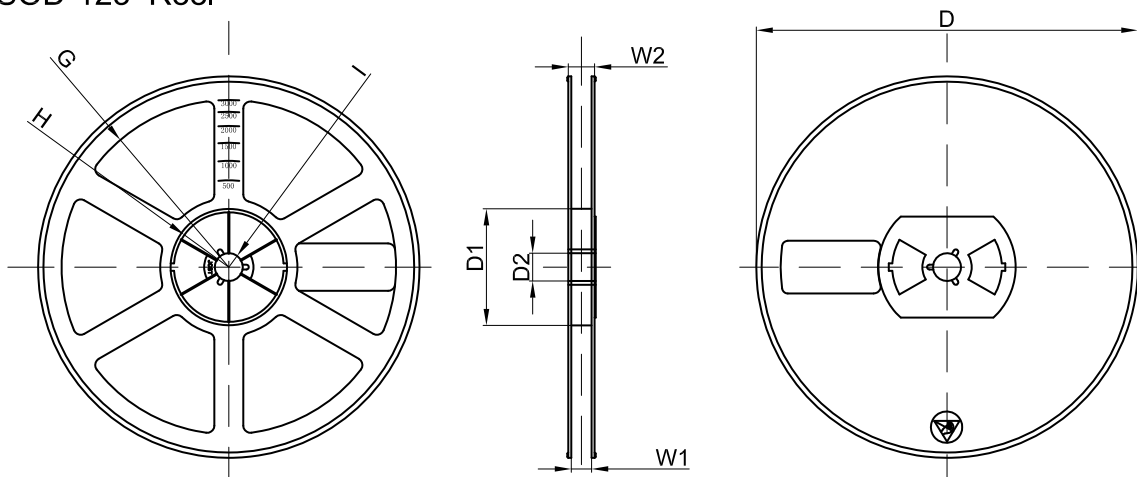

Dimensions are in millimeter								
Reel Option	D	D1	D2	G	H	I	W1	W2
7"Dia	Ø178.00	54.40	13.00	R78.00	R25.60	R6.50	9.50	12.30

REEL	Reel Size	Box	Box Size(mm)	Carton	Carton Size(mm)	G.W.(kg)
3000 pcs	7 inch	45,000 pcs	203×203×195	180,000 pcs	438×438×220	