

## SOT-23 Plastic-Encapsulate Diodes

ZENER DIODE

### FEATURES

- Dual zeners in common anode configuration.
- 300mW power dissipation rating.
- Ideally suited for automatic insertion.
- $\Delta V_z$  for both diodes in one case is  $\leq 5\%$ .
- Common cathode style available see DZ series.
- Also available in lead free version.

SOT-23

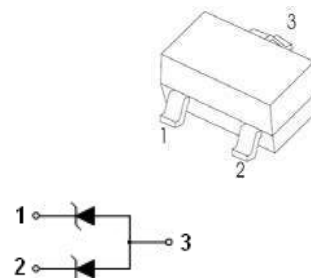

### Maximum Ratings( $T_a=25^\circ\text{C}$ unless otherwise specified)

Characteristic	Symbol	Value	Unit
Forward Voltage @ $I_F = 10\text{mA}$	$V_F$	0.9	V
Power Dissipation	$P_D$	300	mW
Thermal Resistance from Junction to Ambient	$R_{\theta JA}$	417	$^\circ\text{C/W}$
Operation Junction and Storage Temperature Range	$T_J, T_{STG}$	-55~+150	$^\circ\text{C}$

**ELECTRICAL CHARACTERISTICS**

**T<sub>a</sub>=25°C unless otherwise specified**

Type Number	Marking Code	Zener Voltage Range (note1)	Maximum Zener Impedance (note 2)		Typical Temperature Coefficient	Min Reverse Voltage (note1)
		@ I <sub>ZT</sub> =5.0mA	Z <sub>ZT</sub> @I <sub>ZT</sub> =5.0mA	Z <sub>Zk</sub> @I <sub>Zk</sub> =1.0mA		@I <sub>R</sub> =0.1μA
		V <sub>Z</sub> (V)	Ω	Ω	T <sub>c</sub> (%/°C <sub>L</sub> )	V <sub>R</sub> (V)
AZ23C2V7	KD1	2.5-2.9	83	500	-0.065	—
AZ23C3V0	KD2	2.8-3.2	95	500	-0.060	—
AZ23C3V3	KD3	3.1-3.5	95	500	-0.055	—
AZ23C3V6	KD4	3.4-3.8	95	500	-0.055	—
AZ23C3V9	KD5	3.7-4.1	95	500	-0.050	—
AZ23C4V3	KD6	4.0-4.6	95	500	-0.035	—
AZ23C4V7	KD7	4.4-5.0	78	500	-0.015	—
AZ23C5V1	KD8	4.8-5.4	60	480	+0.005	0.8
AZ23C5V6	KD9	5.2-6.0	40	400	+0.020	1.0
AZ23C6V2	KDA	5.8-6.6	10	200	+0.030	2.0
AZ23C6V8	KDB	6.4-7.2	8.0	150	+0.045	3.0
AZ23C7V5	KDC	7.0-7.9	7.0	50	+0.050	5.0
AZ23C8V2	KDD	7.7-8.7	7.0	50	+0.055	6.0
AZ23C9V1	KDE	8.5-9.6	10	50	+0.065	7.0
AZ23C10	KDF	9.4-10.6	15	70	+0.065	7.5
AZ23C11	KDG	10.4-11.6	20	70	+0.070	8.5
AZ23C12	KDH	11.4-12.7	20	90	+0.075	9.0
AZ23C13	KDI	12.4-14.1	25	110	+0.080	10.0
AZ23C15	KDJ	13.8-15.6	30	110	+0.080	11.0
AZ23C16	KDK	15.3-17.1	40	170	+0.090	12.0
AZ23C18	KDL	16.8-19.1	50	170	+0.090	14.0
AZ23C20	KDM	18.8-21.2	50	220	+0.090	15.0
AZ23C22	KDN	20.8-23.3	55	220	+0.090	17.0
AZ23C24	KDO	22.8-25.6	80	220	+0.090	18.0
AZ23C27	KDP	25.1-28.9	80	250	+0.090	20.0
AZ23C30	KDQ	28-32	80	250	+0.090	22.5
AZ23C33	KDR	31-35	80	250	+0.090	25.0
AZ23C36	KDS	34-38	90	250	+0.090	27.0
AZ23C39	KDT	37-41	90	300	+0.110	29.0
AZ23C43	KDU	40-46	100	375	+0.110	32.0
AZ23C47	KDV	44.0-50.0	100	375	+0.110	35.0
AZ23C51	KDW	48.0-54.0	100	400	+0.110	38.0
AZ23C56	KDX	52.0-60.0	110	425	+0.110	41.0
AZ23C62	KDY	58.0-66.0	110	450	+0.110	44.0
AZ23C68	KDZ	64.0-72.0	110	475	+0.110	48.0
AZ23C75	KD10	70.0-79.0	120	520	+0.120	51.5

Notes: 1. Short duration test pulse used to minimize self-heating effect.  
 2. f=1kHz

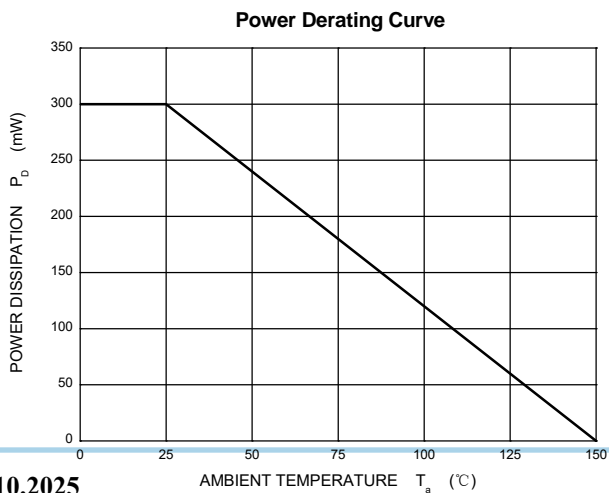
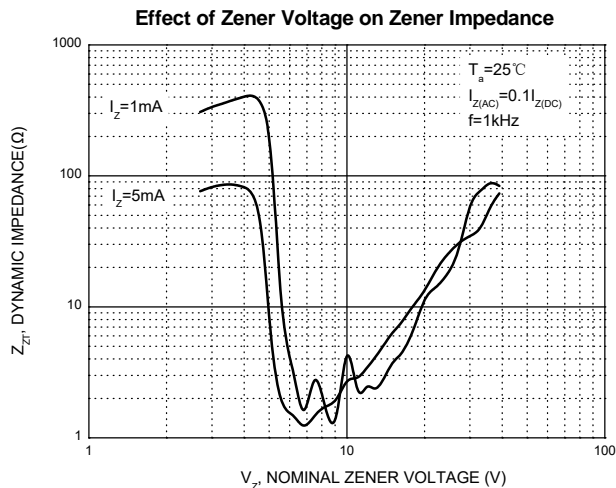
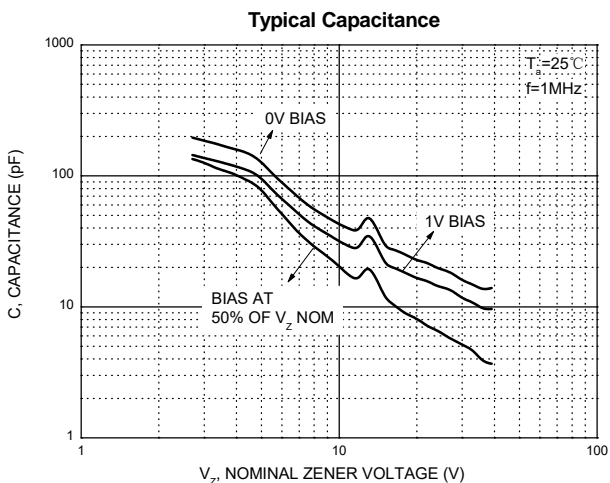
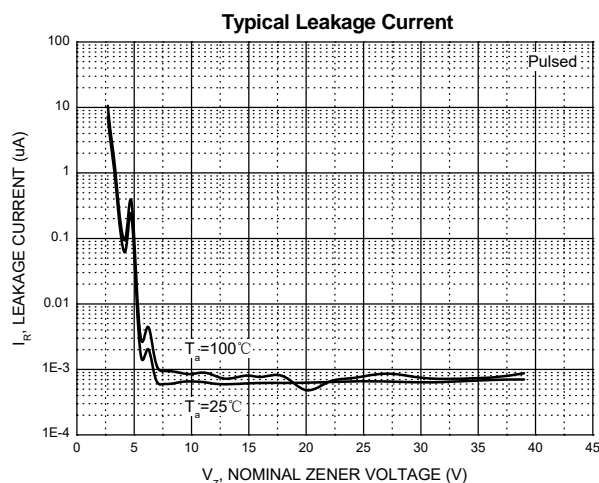
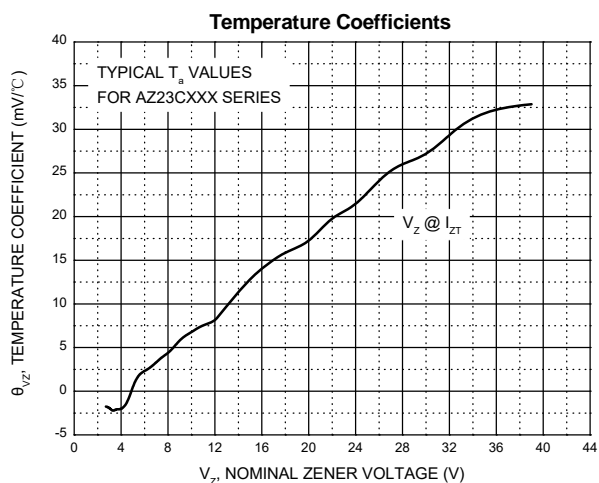
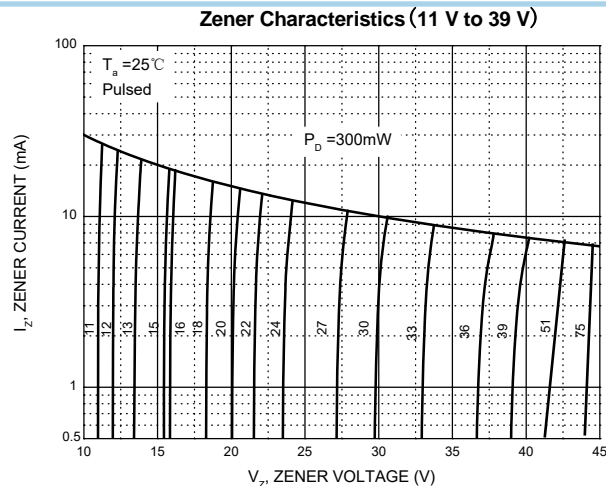
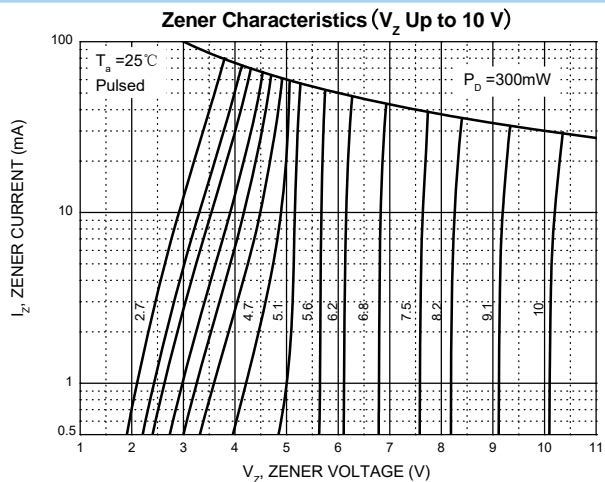

**SOT-23 Package Outline Dimensions**

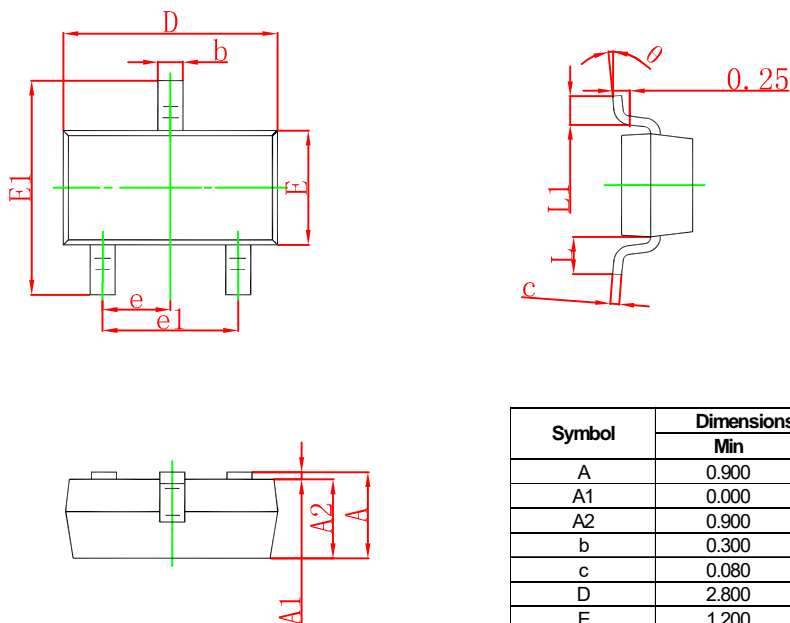

Symbol	Dimensions In Millimeters		Dimensions In Inches	
	Min	Max	Min	Max
A	0.900	1.150	0.035	0.045
A1	0.000	0.100	0.000	0.004
A2	0.900	1.050	0.035	0.041
b	0.300	0.500	0.012	0.020
c	0.080	0.150	0.003	0.006
D	2.800	3.000	0.110	0.118
E	1.200	1.400	0.047	0.055
E1	2.250	2.550	0.089	0.100
e	0.950 TYP		0.037 TYP	
e1	1.800	2.000	0.071	0.079
L	0.550 REF		0.022 REF	
L1	0.300	0.500	0.012	0.020
θ	0°	8°	0°	8°

**SOT-23 Suggested Pad Layout**

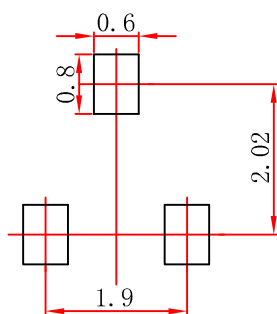

Note:  
 1. Controlling dimension: in millimeters.  
 2. General tolerance: ± 0.05mm.  
 3. The pad layout is for reference purposes only.

### SOT-23 Tape and Reel

#### SOT-23 Embossed Carrier Tape

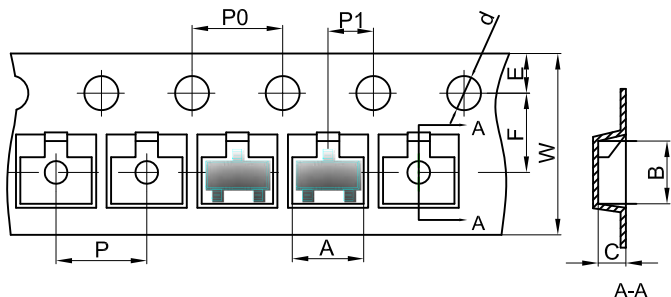

**Packaging Description:**  
 SOT-23 parts are shipped in tape. The carrier tape is made from a dissipative (carbon filled) polycarbonate resin. The cover tape is a multilayer film (Heat Activated Adhesive in nature) primarily composed of polyester film, adhesive layer, sealant, and anti-static sprayed agent. These reeled parts in standard option are shipped with 3,000 units per 7" or 17.8cm diameter reel. The reels are clear in color and is made of polystyrene plastic (anti-static coated).

Dimensions are in millimeter										
Pkg type	A	B	C	d	E	F	P0	P	P1	W
SOT-23	3.15	2.77	1.22	Ø1.50	1.75	3.50	4.00	4.00	2.00	8.00

#### SOT-23 Tape Leader and Trailer

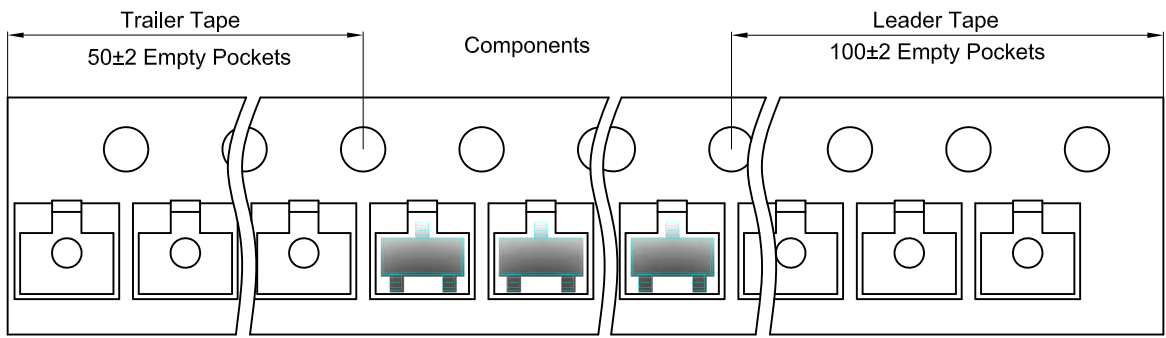

#### SOT-23 Reel

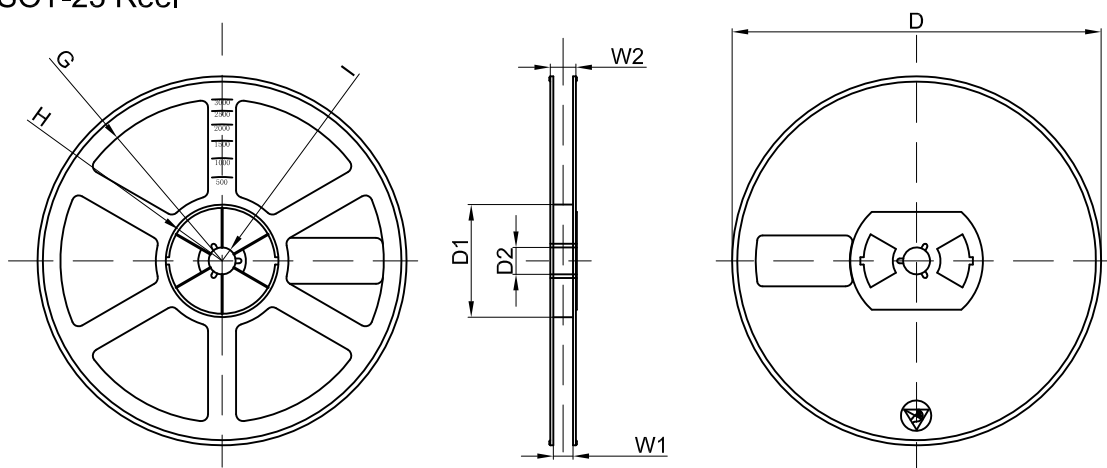

Dimensions are in millimeter								
Reel Option	D	D1	D2	G	H	I	W1	W2
7" Dia	Ø178.00	54.40	13.00	R78.00	R25.60	R6.50	9.50	12.30

REEL	Reel Size	Box	Box Size(mm)	Carton	Carton Size(mm)	G.W.(kg)
3000 pcs	7 inch	45,000 pcs	203×203×195	180,000 pcs	438×438×220	