

## SOD-323 Plastic-Encapsulate Diodes

### Features:

- Low Forward Voltage Drop
- Very Small SMD Package

### Applications:

- Low Voltage Rectification
- High Efficiency DC/DC Conversion
- Switch Mode Power Supply
- Inverse Polarity Protection
- Low Power Consumption Applications

SOD-323

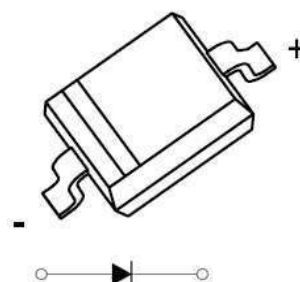

### MARKING: S4



### MAXIMUM RATINGS ( $T_a=25^{\circ}\text{C}$ unless otherwise noted )

Symbol	Parameter	Value	Unit
$V_{RRM}$	Peak Repetitive Reverse Voltage	40	V
$V_{RWM}$	Working Peak Reverse Voltage		
$V_{R(RMS)}$	RMS Reverse Voltage	28	V
$I_O$	Average Rectified Output Current	1	A
$I_{FSM}$	Non-repetitive Peak Forward Surge Current @ $t=8.3\text{ms}$	20	A
$P_D$	Power Dissipation	250	mW
$R_{\theta JA}$	Thermal Resistance from Junction to Ambient	400	$^{\circ}\text{C/W}$
$T_j$	Junction Temperature	125	$^{\circ}\text{C}$
$T_{stg}$	Storage Temperature	-55~+150	$^{\circ}\text{C}$

### ELECTRICAL CHARACTERISTICS( $T_a=25^{\circ}\text{C}$ unless otherwise specified)

Parameter	Symbol	Test conditions	Min	Typ	Max	Unit
Reverse breakdown voltage	$V_{(BR)}$	$I_R=1\text{mA}$	40			V
Reverse current	$I_R$	$V_R=20\text{V}$			50	$\mu\text{A}$
Forward voltage	$V_F$	$I_F=0.5\text{A}$			0.51	V
		$I_F=0.7\text{A}$			0.55	
Total capacitance	$C_{tot}$	$V_R=10\text{V}, f=1\text{MHz}$			20	pF

**Typical Characteristics**

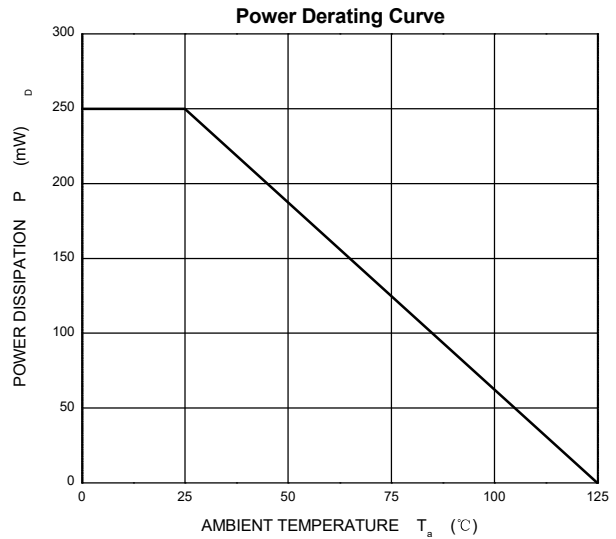
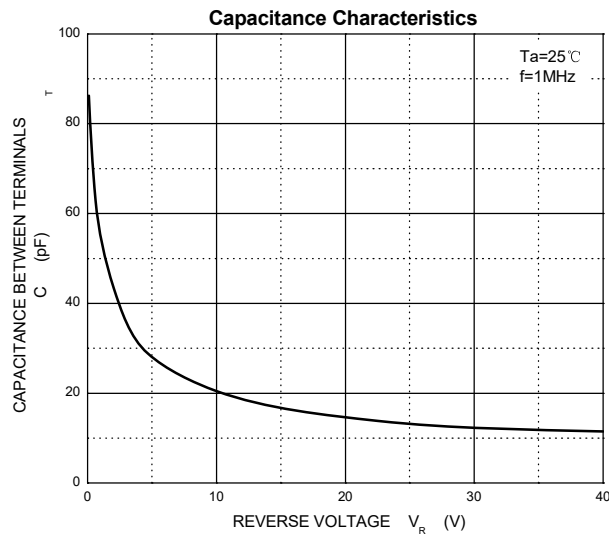
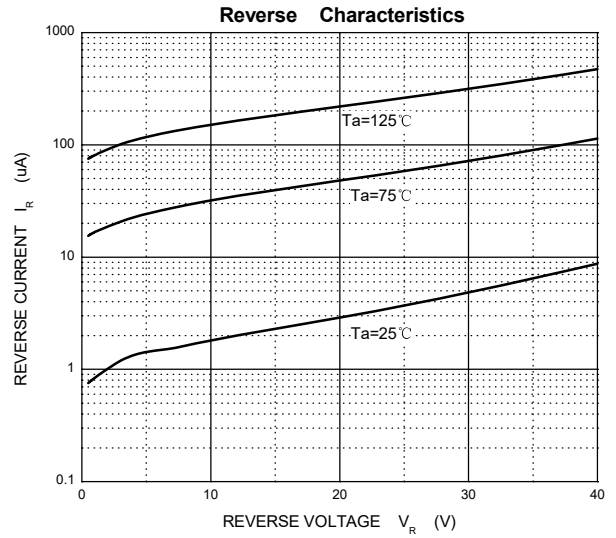
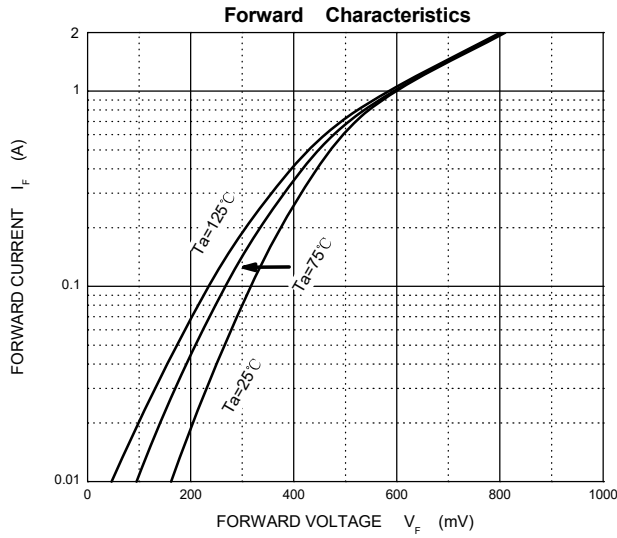

### SOD-323 Package Outline Dimensions

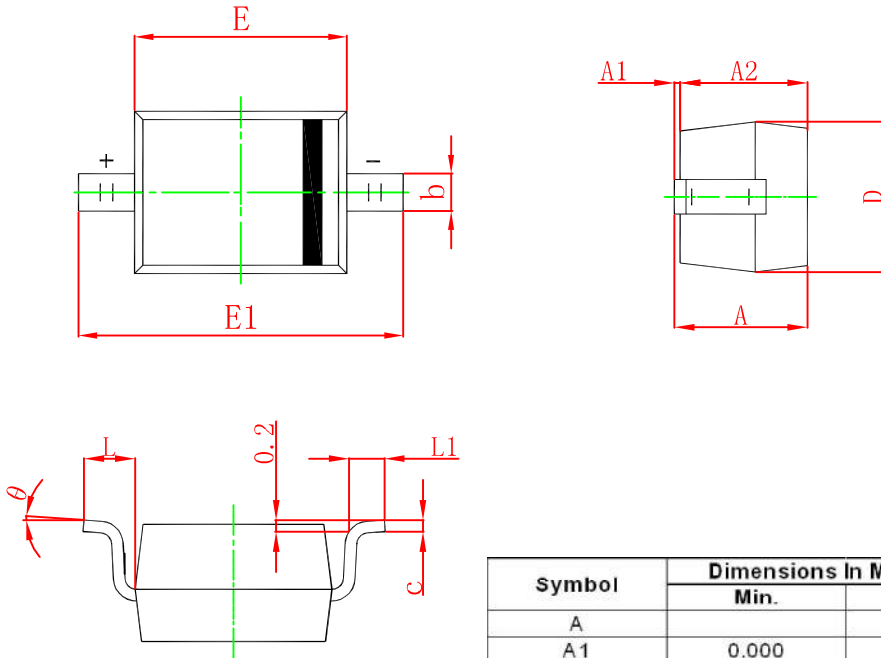

Symbol	Dimensions In Millimeters		Dimensions In Inches	
	Min.	Max.	Min.	Max.
A		1.000		0.039
A1	0.000	0.100	0.000	0.004
A2	0.800	0.900	0.031	0.035
b	0.250	0.350	0.010	0.014
c	0.080	0.150	0.003	0.006
D	1.200	1.400	0.047	0.055
E	1.600	1.800	0.063	0.071
E1	2.550	2.750	0.100	0.108
L	0.475 REF.		0.019 REF.	
L1	0.250	0.400	0.010	0.016
θ	0°		8°	

### SOD-323 Suggested Pad Layout

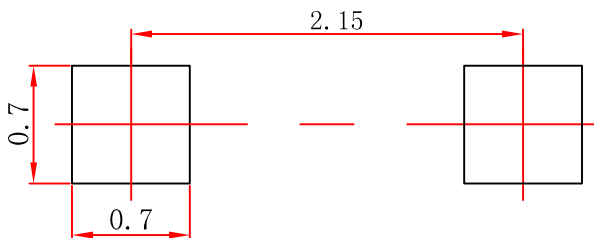

**Note:**

1. Controlling dimension: in millimeters.
2. General tolerance:  $\pm 0.05$ mm.
3. The pad layout is for reference purposes only.

**SOD-323 Tape and Reel**

**SOD-323 Embossed Carrier Tape**

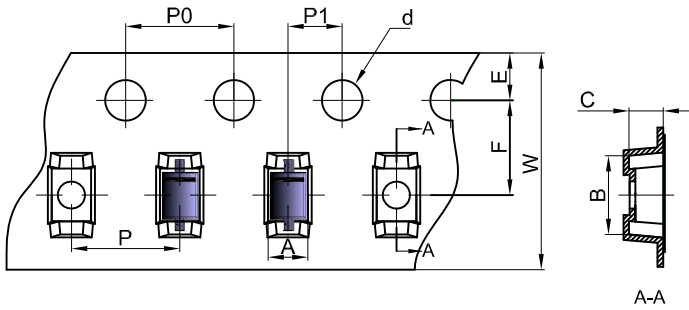

**Packaging Description:**  
 SOD-323 parts are shipped in tape. The carrier tape is made from a dissipative (carbon filled) polycarbonate resin. The cover tape is a multilayer film (Heat Activated Adhesive in nature) primarily composed of polyester film, adhesive layer, sealant, and anti-static sprayed agent. These reeled parts in standard option are shipped with 3,000 units per 7" or 17.8cm diameter reel. The reels are clear in color and is made of polystyrene plastic (anti-static coated).

Dimensions are in millimeter										
Pkg type	A	B	C	d	E	F	P0	P	P1	W
SOD-323	1,48	3,3	1,25	Ø1.50	1,75	3,50	4,00	4,00	2,00	8,00

**SOD-323 Tape Leader and Trailer**

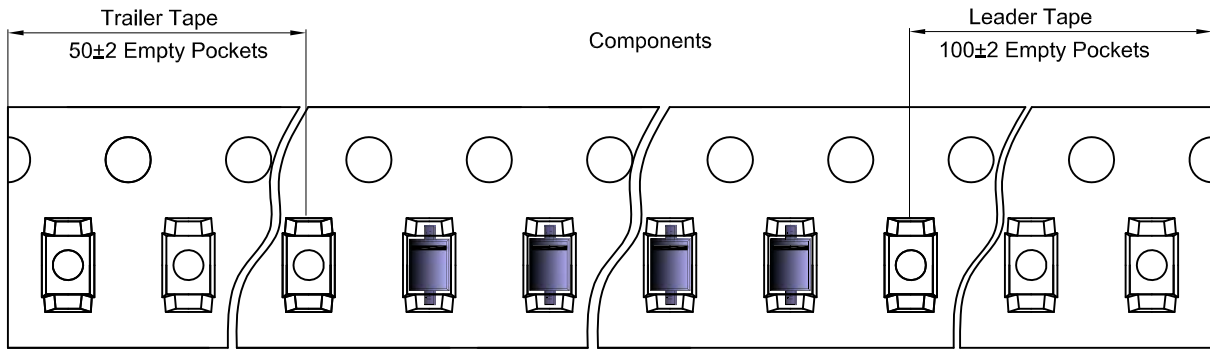

**SOD-323 Reel**

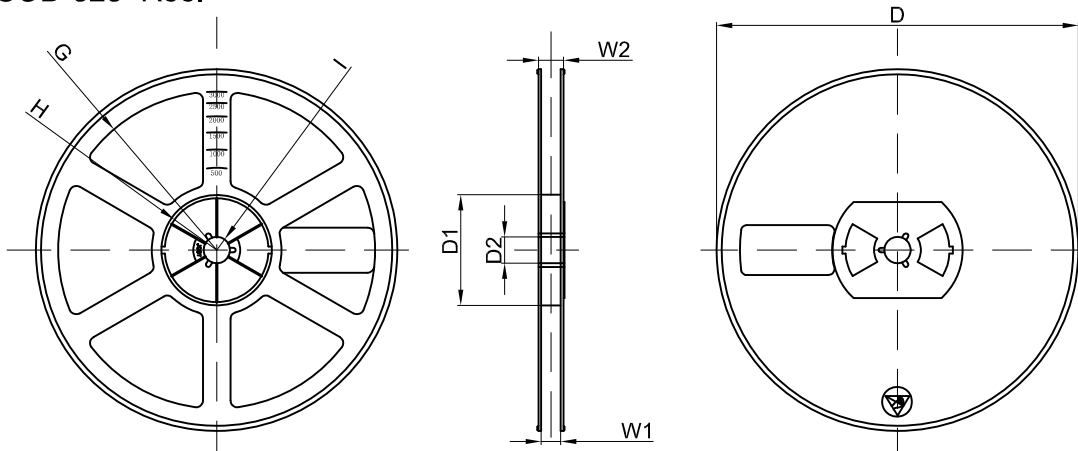

Dimensions are in millimeter								
Reel Option	D	D1	D2	G	H	I	W1	W2
7"Dia	Ø178.00	54.40	13.00	R78.00	R25.60	R6.50	9.50	12.30

REEL	Reel Size	Box	Box Size(mm)	Carton	Carton Size(mm)	G.W.(kg)
3000 pcs	7 inch	45,000 pcs	203×203×195	180,000 pcs	438×438×220	