

TO- 277 Plastic-Encapsulate Diodes

Schottky Rectifier Diode

Features

- $I_{F(AV)}$ 15A
- V_{RRM} 45V
- High surge current capability
- Low peak forward voltage

Applications

- Rectifier

Marking

- SB1545L

TO-277

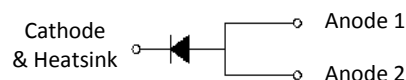
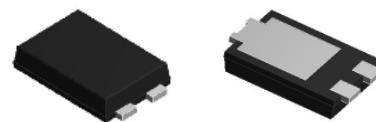

Limiting Values(Absolute Maximum Rating)

| Item | Symbol | Unit | Test Conditions | KSB1545L |
|--------------------------------------|-------------|------------------|--|------------|
| Repetitive Peak Reverse Voltage | V_{RRM} | V | | 45 |
| Maximum RMS Voltage | V_{RMS} | V | | 42 |
| Average Forward Current | $I_{F(AV)}$ | A | 60Hz Half-sine wave, Resistance load, $T_a=125^\circ\text{C}$ | 15 |
| Surge(Non-repetitive)Forward Current | I_{FSM} | A | 60Hz Half-sine wave, 1 cycle, $T_a=25^\circ\text{C}$ | 300 |
| Junction Temperature | T_J | $^\circ\text{C}$ | | -55 ~ +150 |
| Storage Temperature | T_{STG} | $^\circ\text{C}$ | | -55 ~ +150 |

Electrical Characteristics ($T=25^\circ\text{C}$ Unless otherwise specified)

| Item | Symbol | Unit | Test Condition | | KSB1545L | |
|------------------------------|------------------|---------------------------|-------------------------------------|-------------------------|------------|------------|
| Peak Forward Voltage | V_F | V | $I_F=15.0\text{A}$ | $T_a=25^\circ\text{C}$ | 0.45 (TYP) | 0.47 (MAX) |
| | | | | $T_a=125^\circ\text{C}$ | 0.42 (TYP) | 0.45 (MAX) |
| Peak Reverse Current | I_{RRM1} | mA | $V_{RM}=V_{RRM}$ | $T_a=25^\circ\text{C}$ | 0.06(TYP) | 0.20(MAX) |
| | I_{RRM2} | | | $T_a=125^\circ\text{C}$ | 25(TYP) | 50(MAX) |
| Thermal Resistance(Typical) | $R_{\theta J-A}$ | $^\circ\text{C}/\text{W}$ | Between junction and ambient | | 80 | |
| | $R_{\theta J-L}$ | | Between junction and terminal | | 25 | |
| Typical junction capacitance | C_J | nF | $V_R=4.0\text{V}$, $f=1\text{MHz}$ | | 0.95 | |

Notes:

Thermal resistance from junction to ambient and from junction to lead mounted on P.C.B. with 0.3" x 0.3" (8.0 mm x 8.0 mm) copper pad areas

Typical Characteristics

FIG.1: FORWARD CURRENT DERATING CURVE

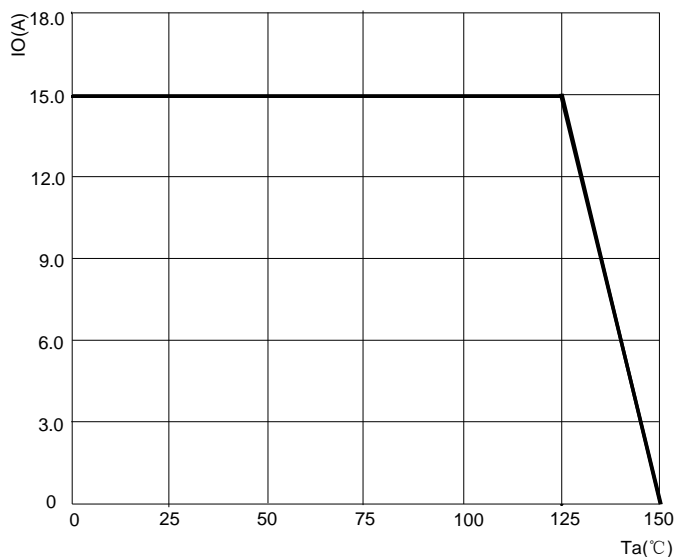

FIG.2: MAXIMUM NON-REPETITIVE FORWARD SURGE CURRENT

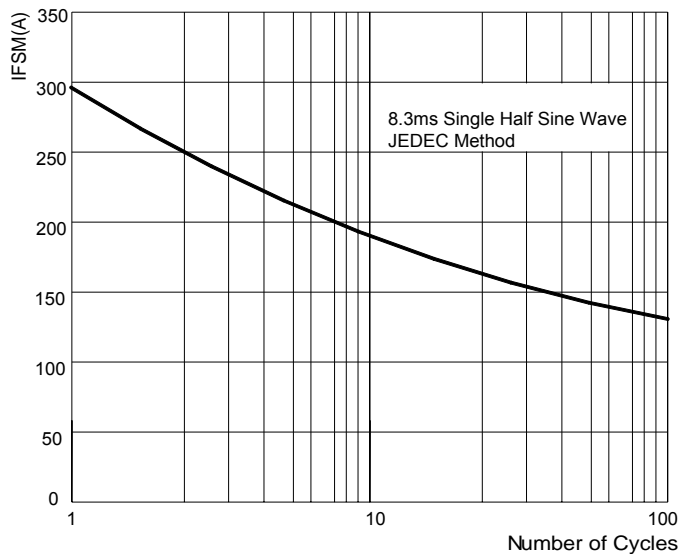

FIG.3: INSTANTANEOUS FORWARD CHARACTERISTICS

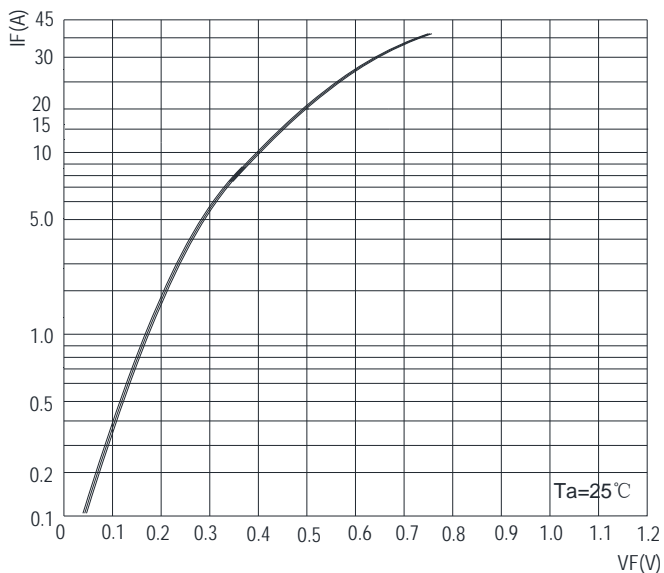
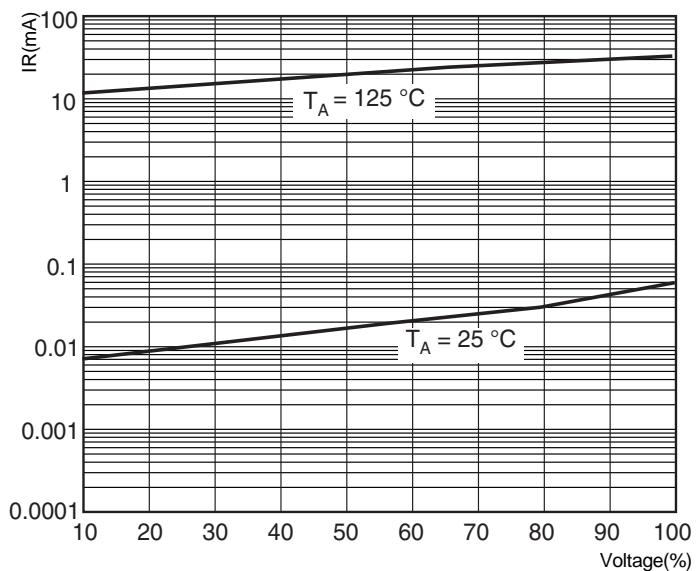
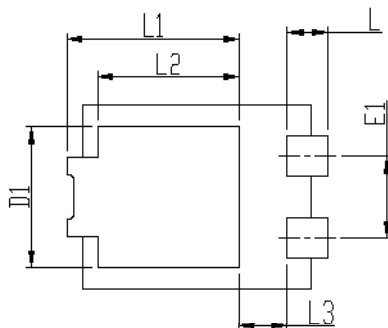
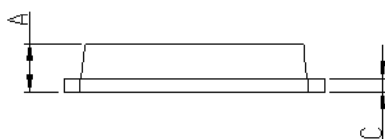
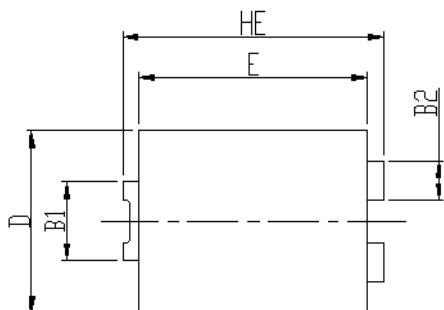

FIG.4: TYPICAL REVERSE CHARACTERISTICS



TO- 277 Package Outline Dimensions



| DIM | Unit: mm | | Unit: inch | |
|-----|-----------|-----|------------|-------|
| | MIN | MAX | MIN | MAX |
| HE | 6.4 | 6.6 | 0.252 | 0.260 |
| E | 5.6 | 5.8 | 0.220 | 0.228 |
| D | 4.1 | 4.3 | 0.161 | 0.169 |
| B1 | 1.7 | 1.9 | 0.067 | 0.075 |
| B2 | 0.8 | 1 | 0.031 | 0.039 |
| A | 1.05 | 1.2 | 0.041 | 0.047 |
| C | 0.3 | 0.4 | 0.012 | 0.016 |
| L | 0.85 | 1.1 | 0.033 | 0.043 |
| L1 | 4.2 | 4.4 | 0.165 | 0.173 |
| L2 | 3.52 Typ. | | 0.139 Typ. | |
| L3 | 1.1 | 1.4 | 0.043 | 0.055 |
| D1 | 3 | 3.3 | 0.118 | 0.130 |
| E1 | 1.86 Typ. | | 0.073 Typ. | |

TO- 277 Suggested Pad Layout

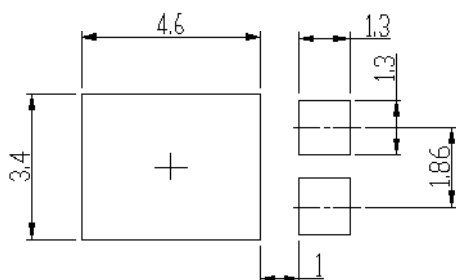

Note:

1. Controlling dimension: in millimeters.
2. General tolerance: ± 0.05 mm.
3. The pad layout is for reference purposes only.