

GBU Plastic-Encapsulate Bridge Rectifier

General Purpose Bridge Rectifier

Features

- I_o 35A
- VRRM 50V-1000V
- High surge current capability
- Glass passivated chip

Applications

- General purpose 1 phase Bridge rectifier applications

Marking

- GBU35XX
- XX : From 005 To 10

GBU

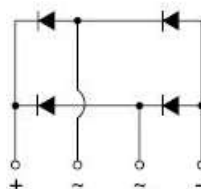
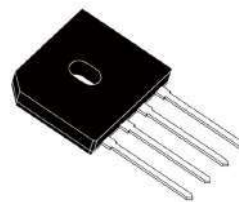

Limiting Values (Absolute Maximum Rating)

Item	Symbol	Unit	Conditions	GBU35						
				005	01	02	04	06	08	10
Repetitive Peak Reverse Voltage	V _{RRM}	V		50	100	200	400	600	800	1000
Maximum RMS Voltage	V _{RMS}	V		35	70	140	280	420	560	700
Average Rectified Output Current	I _o	A	60Hz sine wave, R-load	With heatsink T _c =98°C		35				
				Without heatsink T _a =25°C		4.2				
Surge(Non-repetitive)Forward Current	I _{FSM}	A	60Hz sine wave, 1 cycle, T _j =25°C		400					
Current Squared Time	I ² t	A ² S	1ms≤t<8.3ms T _j =25°C, Rating of per diode		500					
Storage Temperature	T _{stg}	°C			-55 ~+150					
Junction Temperature	T _j	°C			-55 ~+150					
Dielectric Strength	V _{dis}	KV	Terminals to case, AC 1 minute		2.5					
Mounting Torque	Tor	kg • cm	Recommend torque: 5kg • cm		8					

Electrical Characteristics (T_a=25°C Unless otherwise specified)

Item	Symbol	Unit	Test Condition	Max
Peak Forward Voltage	V _{FM}	V	I _{FM} =17.5A, Pulse measurement, Rating of per diode	1.0
Peak Reverse Current	I _{RRM}	μ A	V _{RM} =V _{RRM} , Pulse measurement, Rating of per diode	10
Thermal Resistance	R _{θ J-A}	°C/W	Between junction and ambient, Without heatsink	22
	R _{θ J-C}		Between junction and case, With heatsink	1.0

Typical Characteristics

FIG.1-MAXIMUM FORWARD SURGE CURRENT

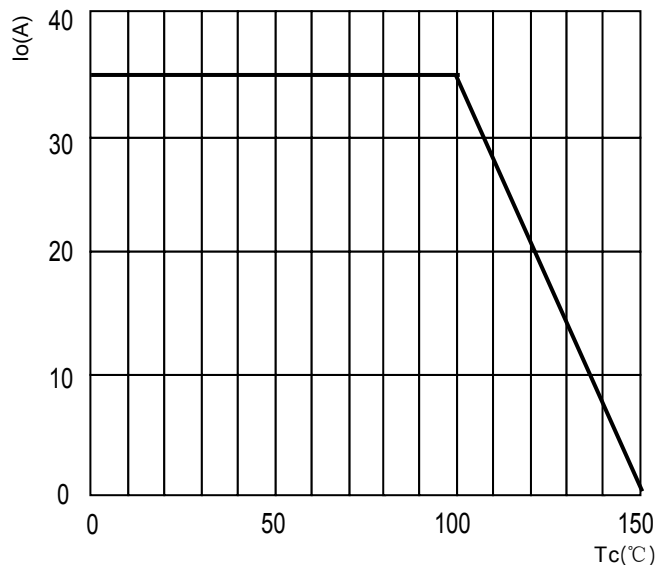

FIG.2-MAXIMUM NON-REPETITIVE SURGE CURRENT

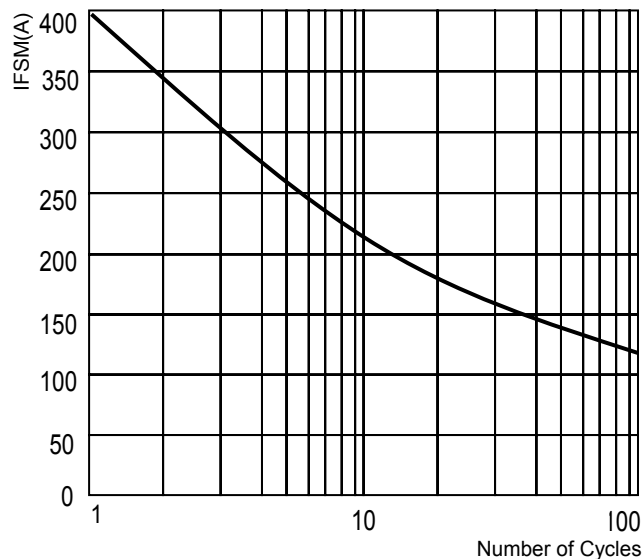

FIG.3-TYPICAL FORWARD CHARACTERISTICS

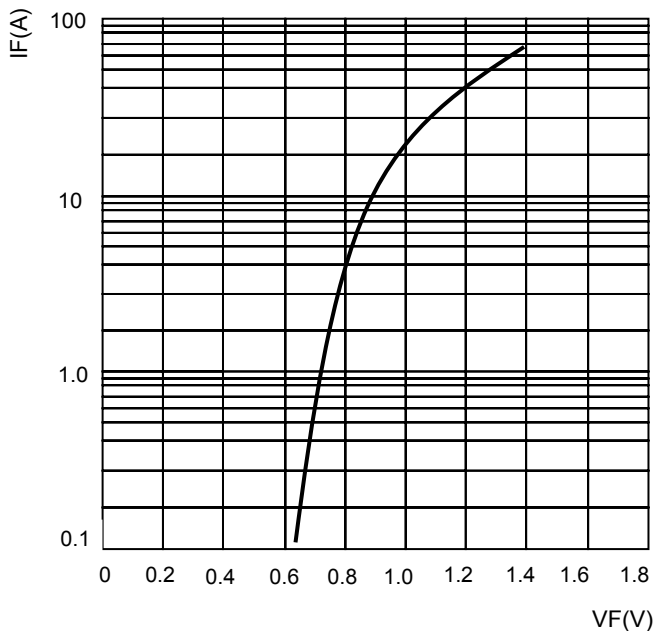
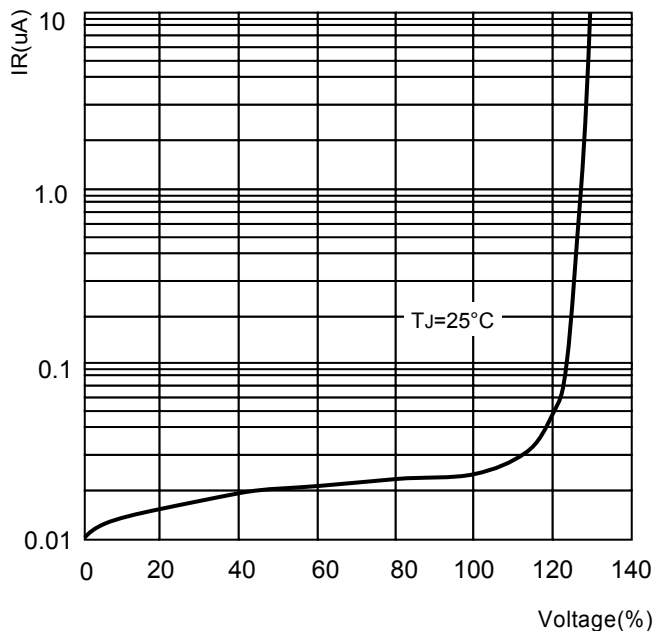
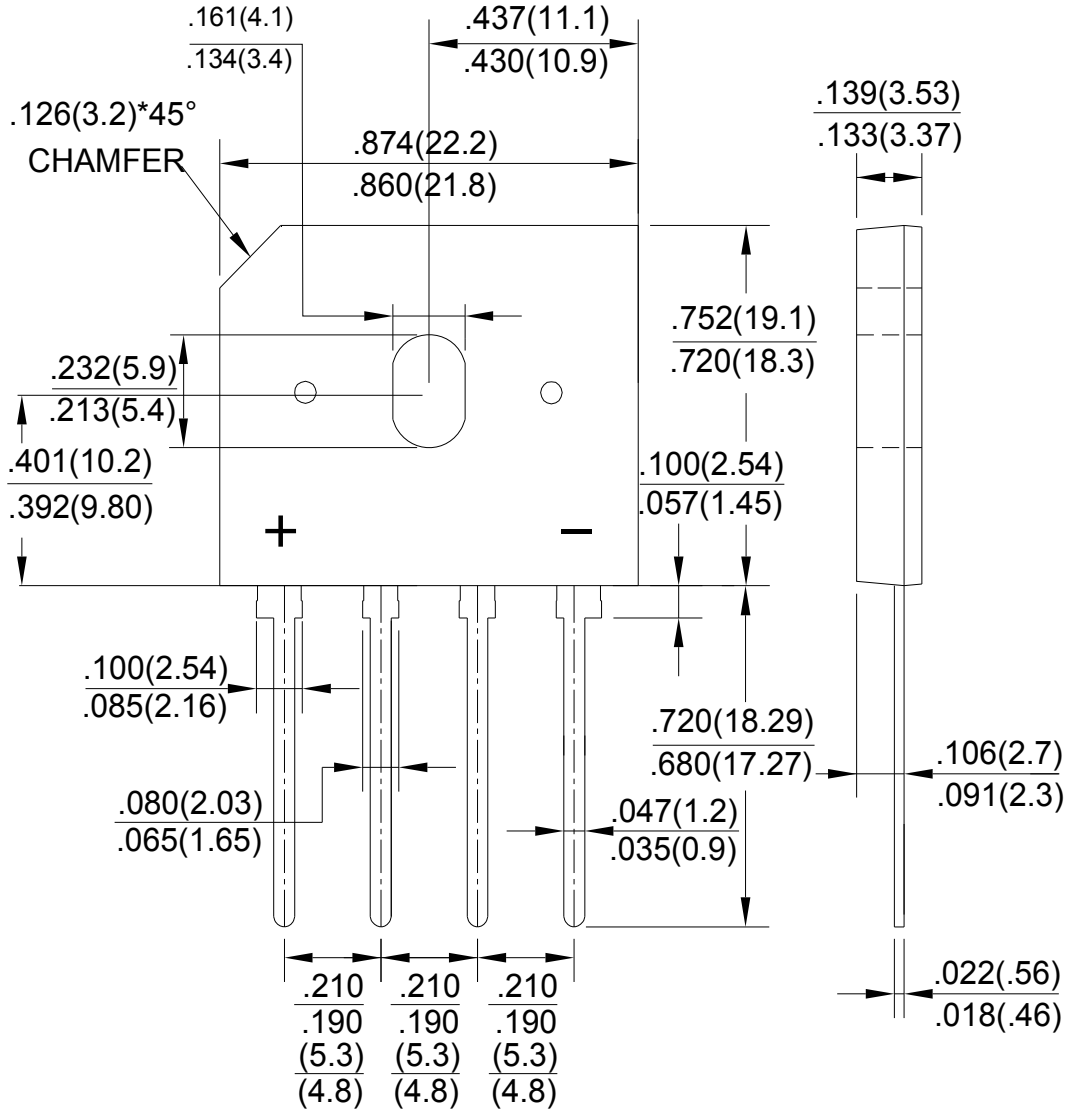

FIG.4-TYPICAL REVERSE CHARACTERISTICS



GBU Package Outline Dimensions



Unit: in inches (millimeters)