

SMA Plastic-Encapsulate Diodes

Fast Recovery Rectifier Diodes

Features

- $I_{F(AV)}$ 2A
- V_{RRM} 50V-1000V
- High surge current capability
- Polarity: Color band denotes cathode

SMA



Applications

- Rectifier

Marking

- RS2X
X : From A To M

Limiting Values(Absolute Maximum Rating)

Item	Symbol	Unit	Test Conditions	RS2						
				A	B	D	G	J	K	M
Repetitive Peak Reverse Voltage	V_{RRM}	V		50	100	200	400	600	800	1000
Maximum RMS Voltage	V_{RMS}	V		35	70	140	280	420	560	700
Average Forward Current	$I_{F(AV)}$	A	60Hz Half-sine wave, Resistance load	2.0						
Surge(Non-repetitive)Forward Current	I_{FSM}	A	60Hz Half-sine wave, 1 cycle, $T_a=25^\circ\text{C}$	50						
Operation Junction and Storage Temperature Range	T_J, T_{STG}	$^\circ\text{C}$		-55 ~ +150						

Electrical Characteristics (T=25 $^\circ\text{C}$ Unless otherwise specified)

Item	Symbol	Unit	Test Condition	RS2						
				A	B	D	G	J	K	M
Peak Forward Voltage	V_F	V	$I_F=2.0\text{A}$	1.3						
Maximum reverse recovery time	t_{rr}	ns	$I_F=0.5\text{A}, I_R=1.0\text{A}, I_{rr}=0.25\text{A}$	150			250		500	
Peak Reverse Current	I_{RRM1}	μA	$V_{RM}=V_{RRM}$	$T_a=25^\circ\text{C}$		5				
	I_{RRM2}			$T_a=125^\circ\text{C}$		50				
Thermal Resistance(Typical)	$R_{\theta J-A}$	$^\circ\text{C}/\text{W}$	Between junction and ambient		75					
	$R_{\theta J-L}$		Between junction and terminal		27					
Junction Capacitance (Typical)	C_j	pF	Measured at 1MHZ and Applied Reverse Voltage of 4.0 V.D.C		11					

Notes:

Thermal resistance from junction to ambient and from junction to lead mounted on FR4 PCB double sided copper mini pad

Typical Characteristics

FIG.1: FORWARD CURRENT DERATING CURVE

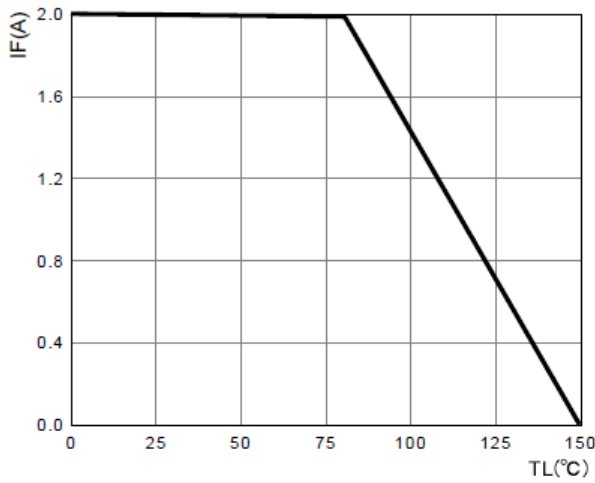

FIG.2: MAXIMUM NON-REPETITIVE FORWARD SURGE CURRENT

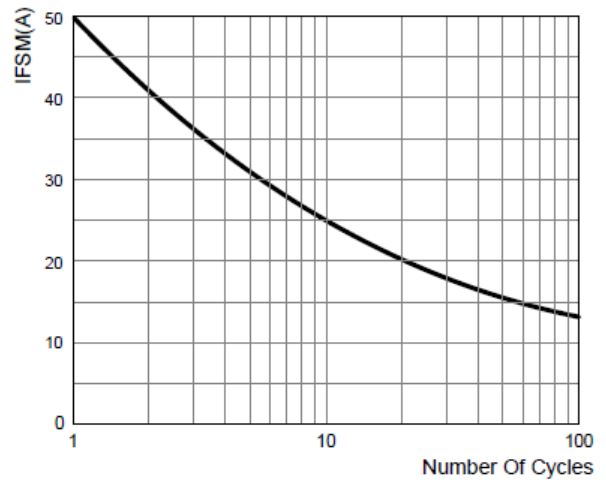

FIG.3 : TYPICAL FORWARD CHARACTERISTICS

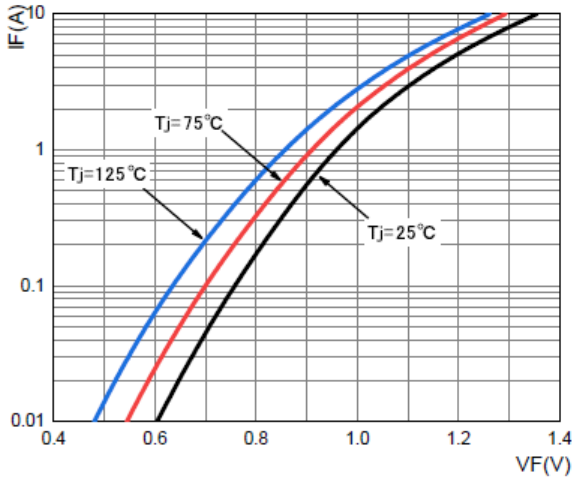

FIG.4 TYPICAL REVERSE CHARACTERISTICS

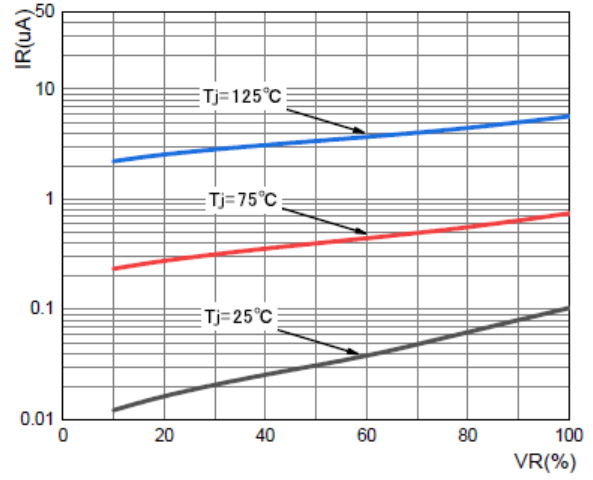
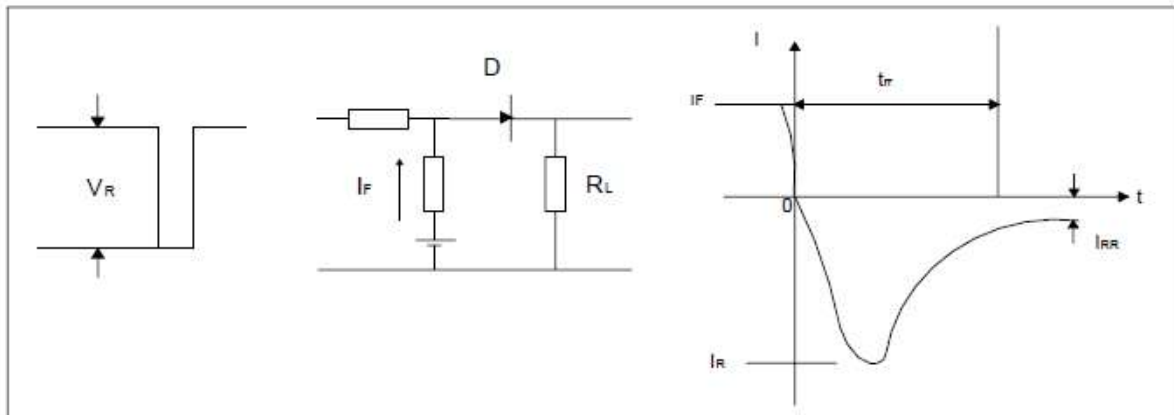
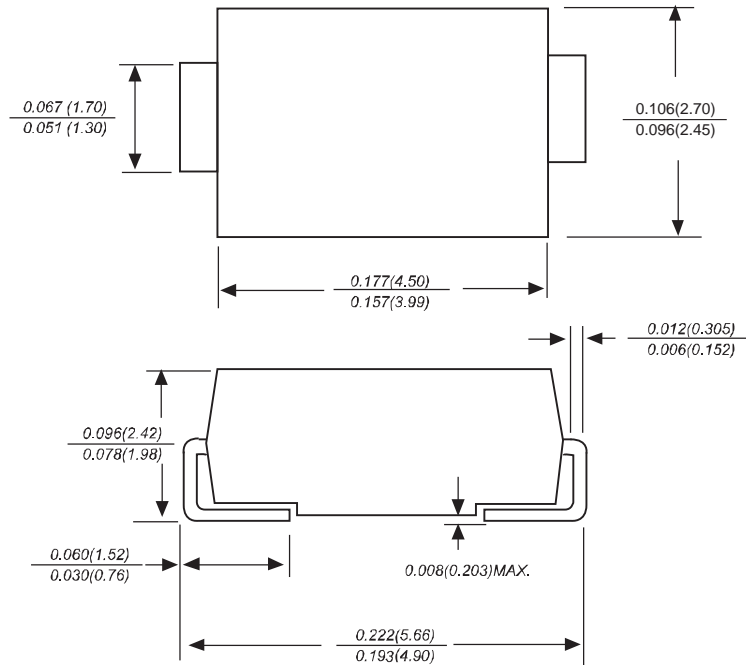

FIG.5: Diagram of circuit and Testing wave form of reverse recovery time



SMA Package Outline Dimensions



Dimensions in inches and (millimeters)

SMA Suggested Pad Layout

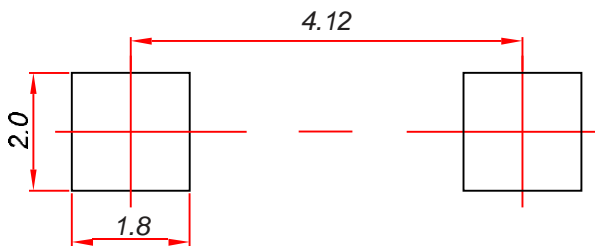

Note:

1. Controlling dimension: in millimeters.
2. General tolerance: $\pm 0.05mm$.
3. The pad layout is for reference purposes only.

Reel Taping Specifications For Surface Mount Devices- SMA

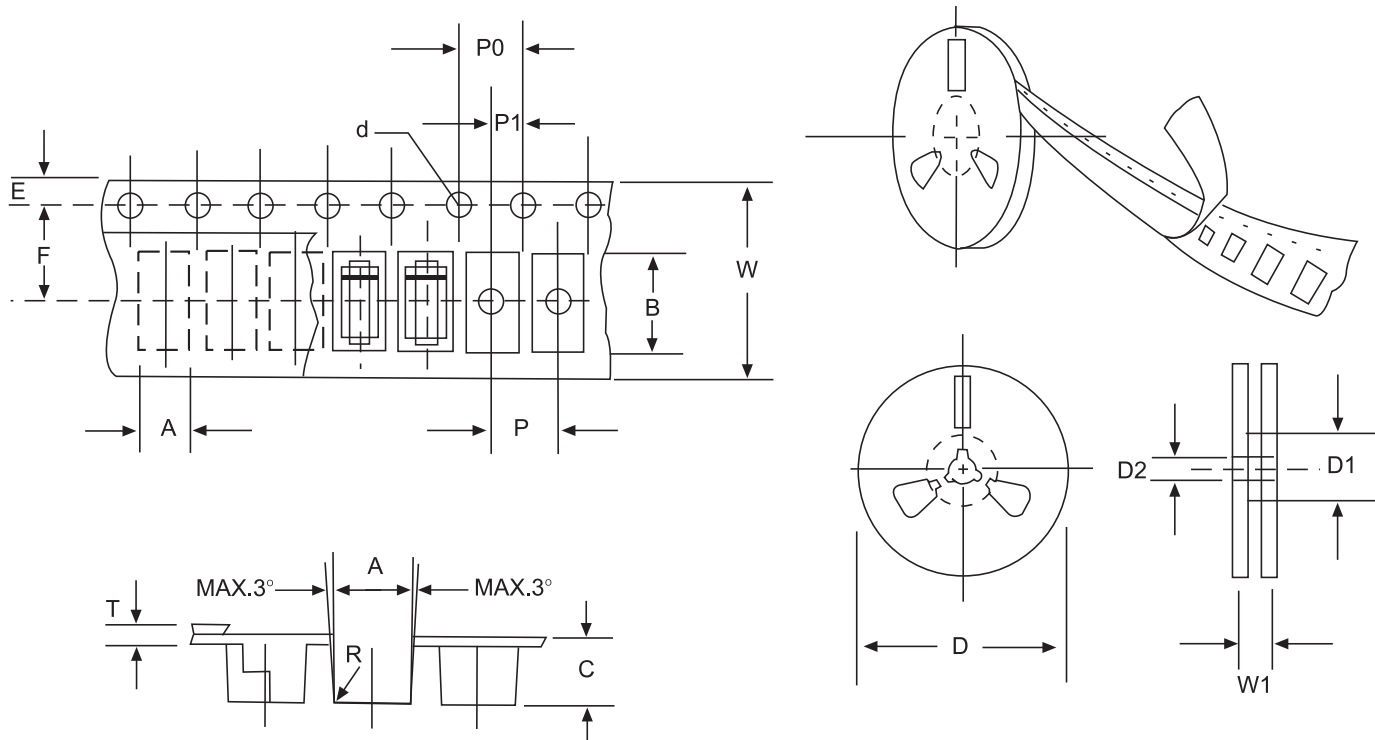

FIG: CONFIGURATION OF SURFACE MOUNTED DEVICES TAPING

ITEM	SYMBOL	SMA mm(inch)
Carrier width	A	2.79±0.1(0.110±0.004)
Carrier length	B	5.33±0.1(0.210±0.004)
Carrier depth	C	2.36±0.1(0.093±0.004)
Sprocket hole	d	1.55±0.05(0.061±0.002)
Reel outside diameter	D	279±2.0 (11± 0.079)
Reel inner diameter	D1	75 ±1.0 (2.95 ±0.039)
Feed hole diameter	D2	13±0.5(0.512±0.020)
Strocket hole position	E	1.75±0.1(0.069±0.004)
Punch hole position	F	5.5±0.05(0.217±0.002)
Punch hole pitch	P	4.0±0.1(0.157±0.004)
Sprocket hole pitch	P0	4.0±0.1(0.157±0.004)
Embossment center	P1	2.0±0.1(0.079±0.004)
Total tape thickness	T	0.28±0.02(0.011 ±0.0008)
Tape width	W	12.0±0.2(0.472±0.008)
Reel width	W1	16.8±2.0(0.661±0.079)

NOTE: Devices are packed in accordance with EIA standard RS-481-A and specification given above.