

## SOD-123 Plastic-Encapsulate Diodes

ZENER DIODE

### Features:

- Planar Die Construction
- Ultra-Small Surface Mount Package
- General purpose, Medium Current
- Ideally Suited for Automated Assembly Processes

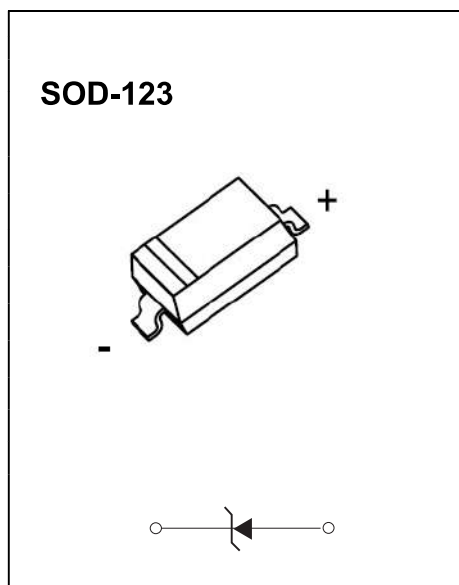

### Maximum Ratings (T<sub>a</sub>=25°C unless otherwise specified)

Characteristic	Symbol	Value	Unit
Forward Voltage (Note 2) @ I <sub>F</sub> = 10mA	V <sub>F</sub>	0.9	V
Power Dissipation(Note 1)	P <sub>d</sub>	350	mW
Thermal Resistance Junction to Ambient Air	R <sub>θJA</sub>	357	°C/W
Operation Junction and Storage Temperature Range	T <sub>J</sub> , T <sub>stg</sub>	-55~+150	°C

Notes: 1. Device mounted on ceramic PCB; 5.0mm x 7.0 mm with pad areas 35 mm<sup>2</sup>.  
 2. Tested with pulses, T<sub>p</sub> ≤ 1.0ms.

## ELECTRICAL CHARACTERISTICS

T<sub>a</sub>=25°C unless otherwise specified

Type Number	Code	Zener Voltage Range (Note 2)				Maximum Zener Impedance (Note 4)			Maximum Reverse Current	
		V <sub>Z</sub> @I <sub>ZT</sub>			I <sub>ZT</sub>	Z <sub>ZT</sub> @I <sub>ZT</sub>	Z <sub>ZK</sub> @I <sub>ZK</sub>	I <sub>ZK</sub>	I <sub>R</sub>	V <sub>R</sub>
		Nom(V)	Min(V)	Max(V)	mA	Ω		mA	uA	V
MMSZ5221C	2C1	2.4	2.35	2.45	20	30	1200	0.25	100	1.0
MMSZ5223C	2C3	2.7	2.65	2.75	20	30	1300	0.25	75	1.0
MMSZ5225C	2C5	3.0	2.94	3.06	20	30	1600	0.25	50	1.0
MMSZ5226C	2G1	3.3	3.23	3.37	20	28	1600	0.25	25	1.0
MMSZ5227C	2G2	3.6	3.53	3.67	20	24	1700	0.25	15	1.0
MMSZ5228C	2G3	3.9	3.82	3.98	20	23	1900	0.25	10	1.0
MMSZ5229C	2G4	4.3	4.21	4.39	20	22	2000	0.25	5	1.0
MMSZ5230C	2G5	4.7	4.61	4.79	20	19	1900	0.25	5	2.0
MMSZ5231C	2E1	5.1	5.00	5.20	20	17	1600	0.25	5	2.0
MMSZ5232C	2E2	5.6	5.49	5.71	20	11	1600	0.25	5	3.0
MMSZ5233C	2E3	6.0	5.88	6.12	20	7	1600	0.25	5	3.5
MMSZ5234C	2E4	6.2	6.08	6.32	20	7	1000	0.25	5	4.0
MMSZ5235C	2E5	6.8	6.66	6.94	20	5	750	0.25	3	5.0
MMSZ5236C	2F1	7.5	7.35	7.65	20	6	500	0.25	3	6.0
MMSZ5237C	2F2	8.2	8.04	8.36	20	8	500	0.25	3	6.5
MMSZ5238C	2F3	8.7	8.53	8.87	20	8	600	0.25	3	6.5
MMSZ5239C	2F4	9.1	8.92	9.28	20	10	600	0.25	3	7.0
MMSZ5240C	2F5	10	9.80	10.20	20	17	600	0.25	3	8.0
MMSZ5241C	2H1	11	10.78	11.22	20	22	600	0.25	2.0	8.4
MMSZ5242C	2H2	12	11.76	12.24	20	30	600	0.25	1.0	9.1
MMSZ5243C	2H3	13	12.74	13.26	9.5	13	600	0.25	0.5	9.9
MMSZ5244C	2H4	14	13.72	14.28	9.0	15	600	0.25	0.1	10
MMSZ5245C	2H5	15	14.70	15.30	8.5	16	600	0.25	0.1	11
MMSZ5246C	2J1	16	15.68	16.32	7.8	17	600	0.25	0.1	12
MMSZ5248C	2J3	18	17.64	18.36	7.0	21	600	0.25	0.1	14
MMSZ5250C	2J5	20	19.60	20.40	6.2	25	600	0.25	0.1	15
MMSZ5251C	2K1	22	21.56	22.44	5.6	29	600	0.25	0.1	17
MMSZ5252C	2K2	24	23.52	24.48	5.2	33	600	0.25	0.1	18
MMSZ5253C	2K3	25	24.50	25.50	5.0	35	600	0.25	0.1	19
MMSZ5254C	2K4	27	26.46	27.54	5.0	41	600	0.25	0.1	21
MMSZ5255C	2K5	28	27.44	28.56	4.5	44	600	0.25	0.1	21
MMSZ5256C	2M1	30	29.40	30.60	4.2	49	600	0.25	0.1	23
MMSZ5257C	2M2	33	32.34	33.66	3.8	58	700	0.25	0.1	25
MMSZ5258C	2M3	36	35.28	36.72	3.4	70	700	0.25	0.1	27
MMSZ5259C	2M4	39	38.22	39.78	3.2	80	800	0.25	0.1	30

**Typical Characteristics**

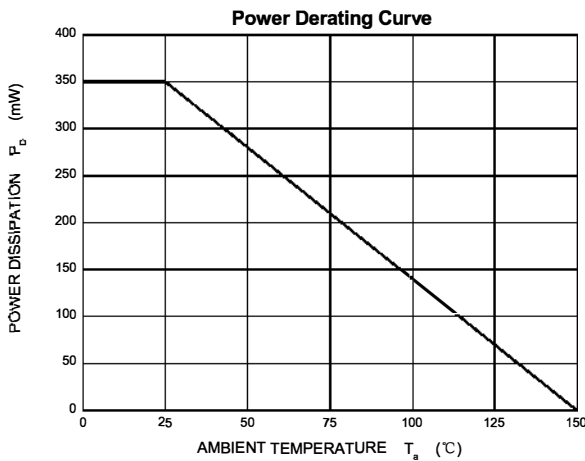
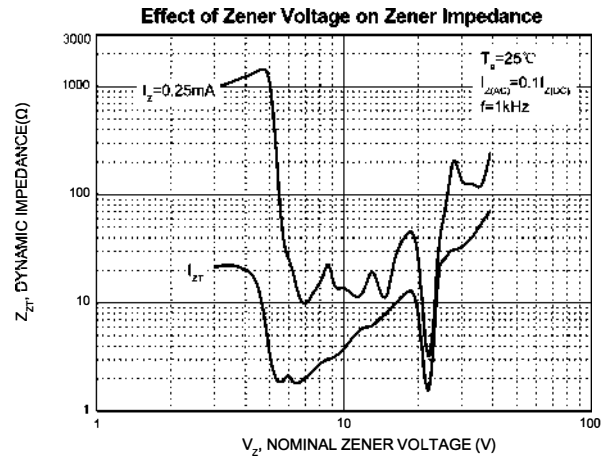
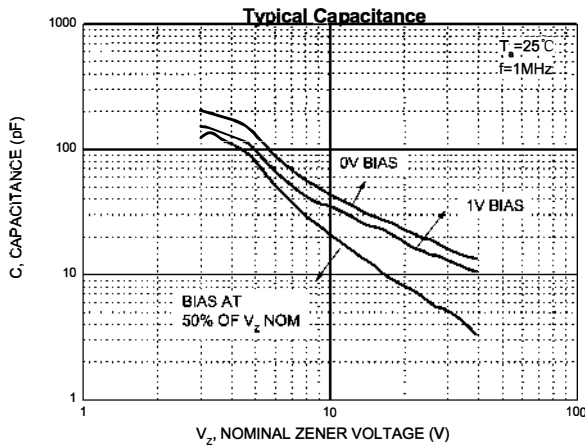
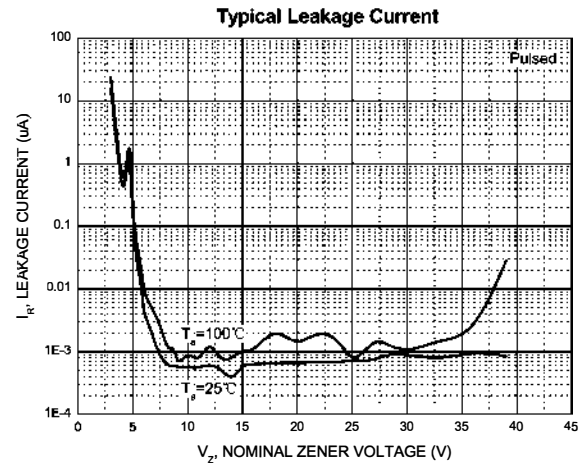
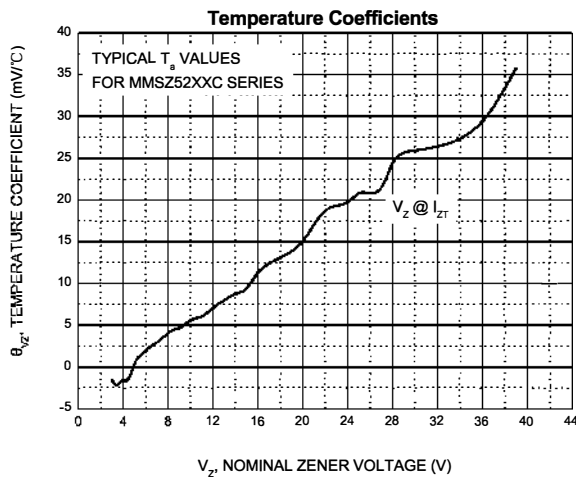
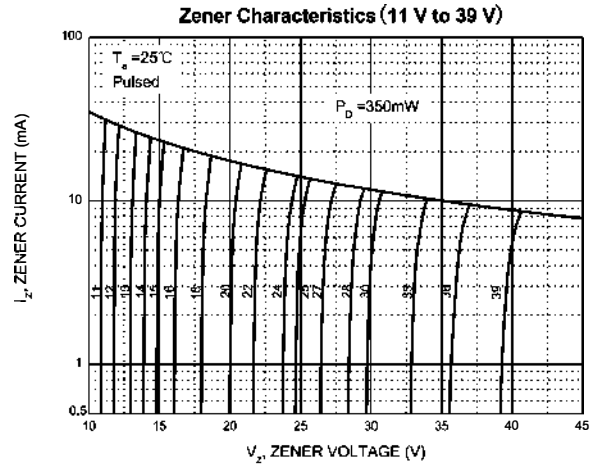
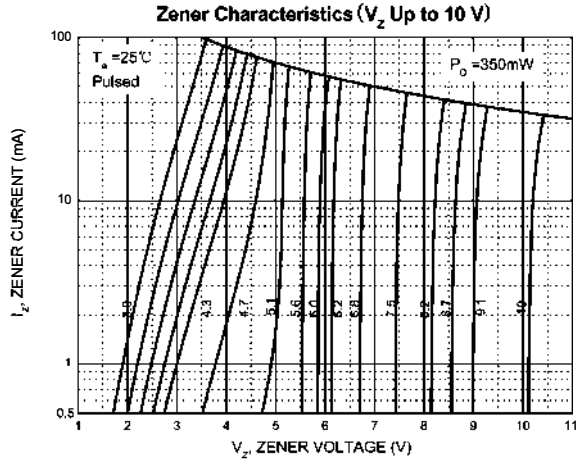

### SOD-123 Package Outline Dimensions

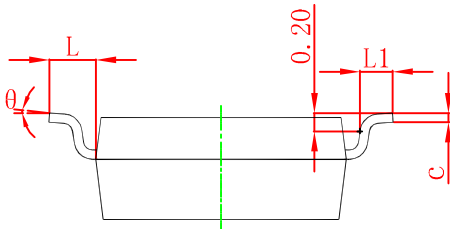
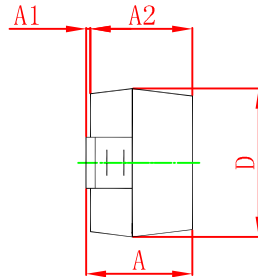
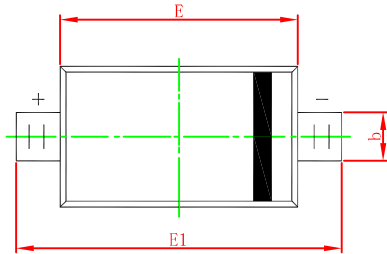

Symbol	Dimensions In Millimeters		Dimensions In Inches	
	Min	Max	Min	Max
A	1.050	1.250	0.041	0.049
A1	0.000	0.100	0.000	0.004
A2	1.050	1.150	0.041	0.045
b	0.450	0.650	0.018	0.026
c	0.080	0.150	0.003	0.006
D	1.500	1.700	0.059	0.067
E	2.600	2.800	0.102	0.110
E1	3.550	3.850	0.140	0.152
L	0.500 REF		0.020 REF	
L1	0.250	0.450	0.010	0.018
θ	0°	8°	0°	8°

### SOD-123 Suggested Pad Layout

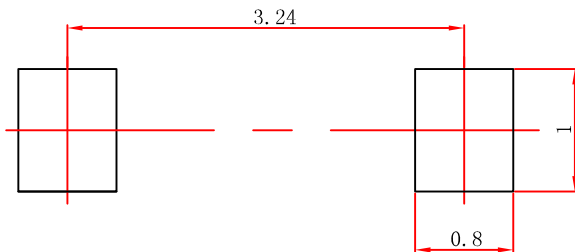

**Note:**

1. Controlling dimension: in millimeters.
2. General tolerance:  $\pm 0.05$ mm.
3. The pad layout is for reference purposes only.

**SOD-123 Tape and Reel**

**SOD-123 Embossed Carrier Tape**

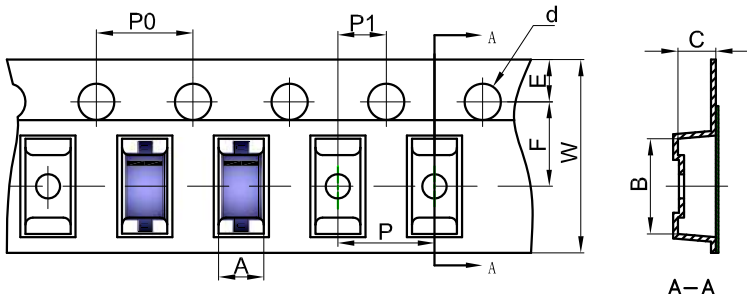

**Packaging Description:**

SOD-123 parts are shipped in tape. The carrier tape is made from a dissipative (carbon filled) polycarbonate resin. The cover tape is a multilayer film (Heat Activated Adhesive in nature) primarily composed of polyester film, adhesive layer, sealant, and anti-static sprayed agent. These reeled parts in standard option are shipped with 3,000 units per 7" or 17.8cm diameter reel. The reels are clear in color and is made of polystyrene plastic (anti-static coated).

Dimensions are in millimeter										
Pkg type	A	B	C	d	E	F	P0	P	P1	W
SOD-123	1.85	3.95	1.57	Ø1.55	1.75	3.50	4.00	4.00	2.00	8.00

**SOD-123 Tape Leader and Trailer**

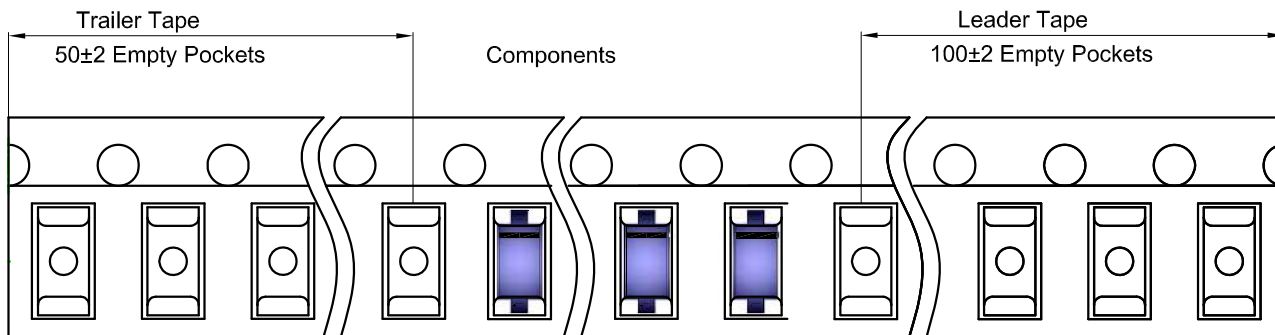

**SOD-123 Reel**

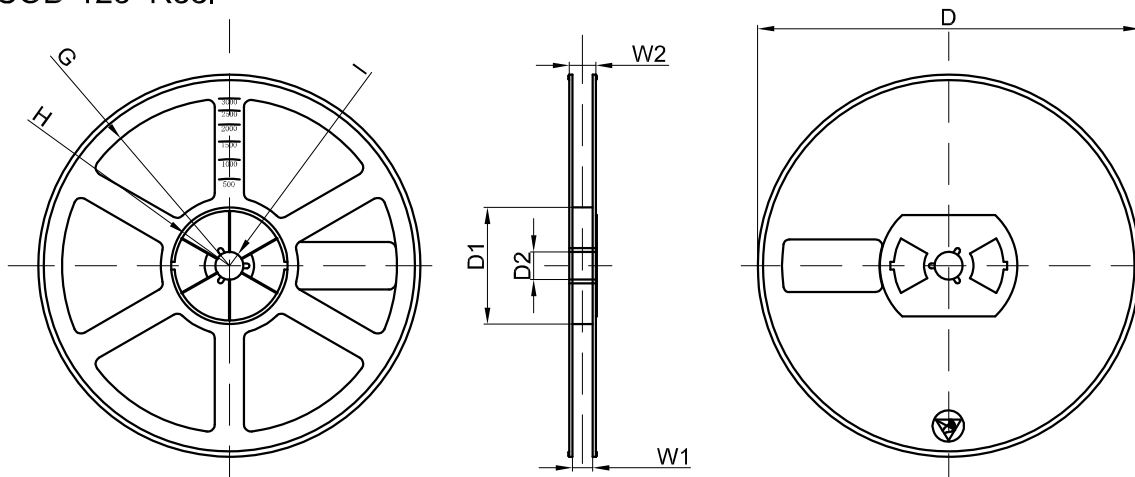

Dimensions are in millimeter								
Reel Option	D	D1	D2	G	H	I	W1	W2
7"Dia	Ø178.00	54.40	13.00	R78.00	R25.60	R6.50	9.50	12.30

REEL	Reel Size	Box	Box Size(mm)	Carton	Carton Size(mm)	G.W.(kg)
3000 pcs	7 inch	45,000 pcs	203×203×195	180,000 pcs	438×438×220	