

SOT-23 Plastic-Encapsulate Diodes

ZENER DIODE

Features:

- Planar Die Construction
- General Purpose, Medium Current
- Ideally Suited for Automated Assembly

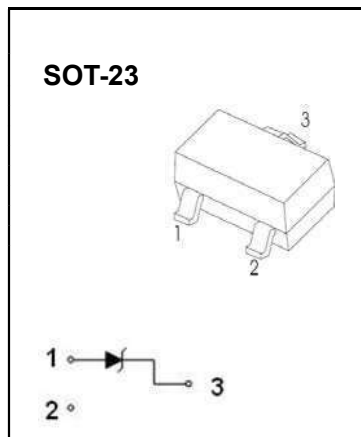

Marking: see table on page2 the marking code

Maximum Ratings($T_a = 25^\circ\text{C}$ unless otherwise specified)

Characteristic	Symbol	Value	Unit
Forward Voltage @ $I_F = 10\text{mA}$	V_F	0.9	V
Power Dissipation	P_D	300	mW
Thermal Resistance from Junction to Ambient	$R_{\theta JA}$	417	$^\circ\text{C}/\text{W}$
Operation Junction and Storage Temperature Range	T_J, T_{STG}	-55~ +150	$^\circ\text{C}$

ELECTRICAL CHARACTERISTICS

T_a=25°C unless otherwise specified

Type Number	Marking Code	Zener Voltage Range (Note 1)			Test Current	Maximum Zener Impedance (Note 2)		Maximum Reverse Leakage Current (Note 1)	
		V _Z @ I _{ZT}				I _{ZT}	Z _{ZT} @ I _{ZT}	Z _{ZK} @ I _{ZK} = 0.25mA	I _R
		Nom (V)	Min (V)	Max (V)	mA	Ω		μA	V
MMBZ5221B	KC1	2.4	2.28	2.52	20	30	1200	100	1.0
MMBZ5222B	KC2	2.5	2.38	2.63	20	30	1250	100	1.0
MMBZ5223B	KC3	2.7	2.57	2.84	20	30	1300	75	1.0
MMBZ5225B	KC5	3.0	2.85	3.15	20	30	1600	50	1.0
MMBZ5226B	KG1	3.3	3.14	3.47	20	28	1600	25	1.0
MMBZ5227B	KG2	3.6	3.42	3.78	20	24	1700	15	1.0
MMBZ5228B	KG3	3.9	3.71	4.10	20	23	1900	10	1.0
MMBZ5229B	KG4	4.3	4.09	4.52	20	22	2000	5.0	1.0
MMBZ5230B	KG5	4.7	4.47	4.94	20	19	1900	5.0	2.0
MMBZ5231B	KE1	5.1	4.85	5.36	20	17	1600	5.0	2.0
MMBZ5232B	KE2	5.6	5.32	5.88	20	11	1600	5.0	3.0
MMBZ5233B	KE3	6.0	5.70	6.30	20	7	1600	5.0	3.5
MMBZ5234B	KE4	6.2	5.89	6.51	20	7	1000	5.0	4.0
MMBZ5235B	KE5	6.8	6.46	7.14	20	5	750	3.0	5.0
MMBZ5236B	KF1	7.5	7.13	7.88	20	6	500	3.0	6.0
MMBZ5237B	KF2	8.2	7.79	8.61	20	8	500	3.0	6.5
MMBZ5238B	KF3	8.7	8.27	9.14	20	8	600	3.0	6.5
MMBZ5239B	KF4	9.1	8.65	9.56	20	10	600	3.0	7.0
MMBZ5240B	KF5	10	9.50	10.50	20	17	600	3.0	8.0
MMBZ5241B	KH1	11	10.45	11.55	20	22	600	2.0	8.4
MMBZ5242B	KH2	12	11.40	12.60	20	30	600	1.0	9.1
MMBZ5243B	KH3	13	12.35	13.65	9.5	13	600	0.5	9.9
MMBZ5244B	KH4	14	13.30	14.70	9.0	15	600	0.1	10
MMBZ5245B	KH5	15	14.25	15.75	8.5	16	600	0.1	11
MMBZ5246B	KJ1	16	15.20	16.80	7.8	17	600	0.1	12
MMBZ5247B	KJ2	17	16.15	17.85	7.4	19	600	0.1	13
MMBZ5248B	KJ3	18	17.10	18.90	7.0	21	600	0.1	14
MMBZ5249B	KJ4	19	18.05	19.95	6.6	23	600	0.1	14
MMBZ5250B	KJ5	20	19.00	21.00	6.2	25	600	0.1	15
MMBZ5251B	KK1	22	20.90	23.10	5.6	29	600	0.1	17
MMBZ5252B	KK2	24	22.80	25.20	5.2	33	600	0.1	18
MMBZ5253B	KK3	25	23.75	26.25	5.0	35	600	0.1	19
MMBZ5254B	KK4	27	25.65	28.35	5.0	41	600	0.1	21
MMBZ5255B	KK5	28	26.60	29.40	4.5	44	600	0.1	21
MMBZ5256B	KM1	30	28.50	31.50	4.2	49	600	0.1	23
MMBZ5257B	KM2	33	31.35	34.65	3.8	58	700	0.1	25
MMBZ5258B	KM3	36	34.20	37.80	3.4	70	700	0.1	27
MMBZ5259B	KM4	39	37.05	40.95	3.2	80	800	0.1	30
MMBZ5260B	KM5	43	40.85	45.15	3	93	800	0.1	33
MMBZ5261B	KM6	47	44.65	49.35	2.7	105	1000	0.1	36
MMBZ5262B	KM7	51	48.45	53.55	2.5	125	1100	0.1	39

Notes: 1. Short duration test pulse used to minimize self-heating effect.
 2. f = 1kHz.

Typical Characteristics

Notes: Our company currently provide 3.0V-39V products only

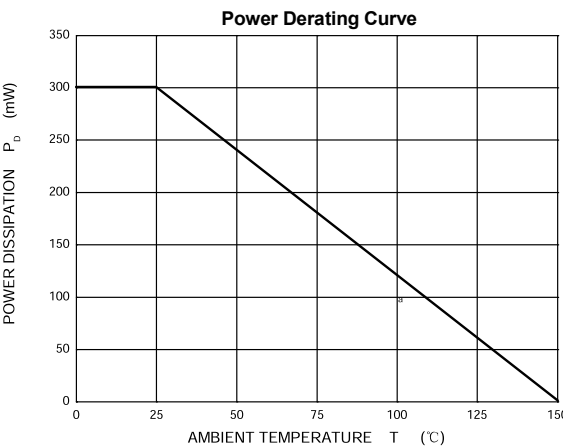
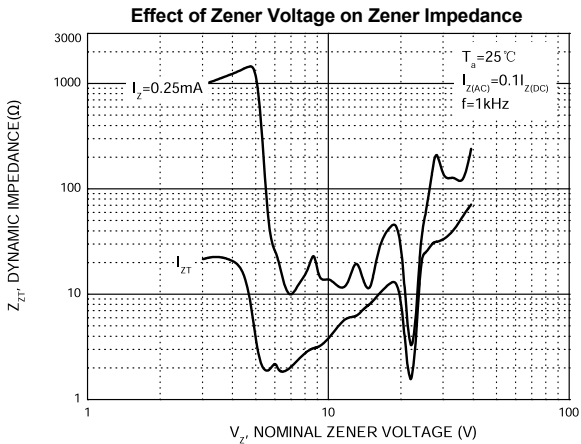
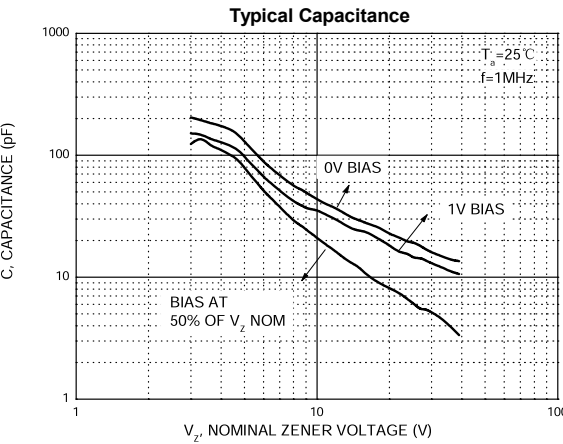
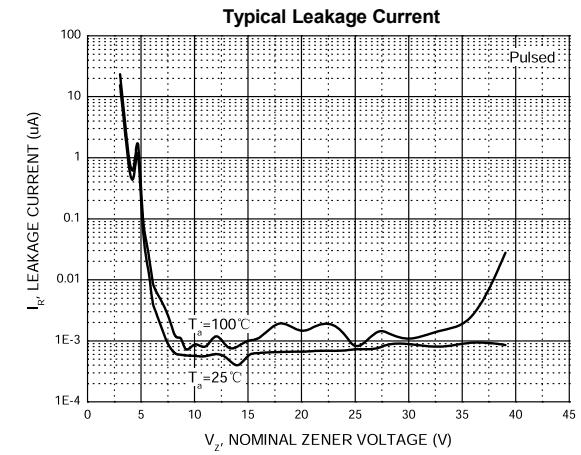
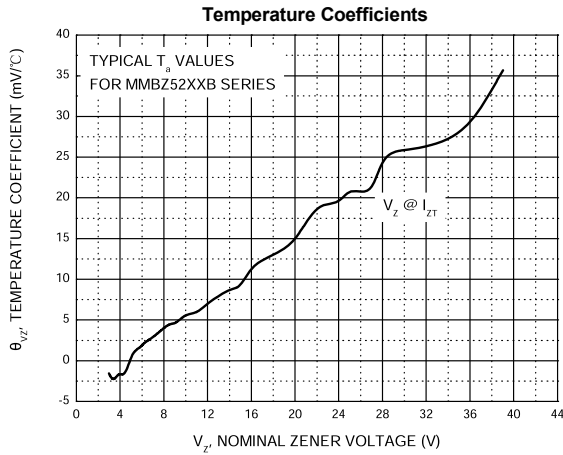
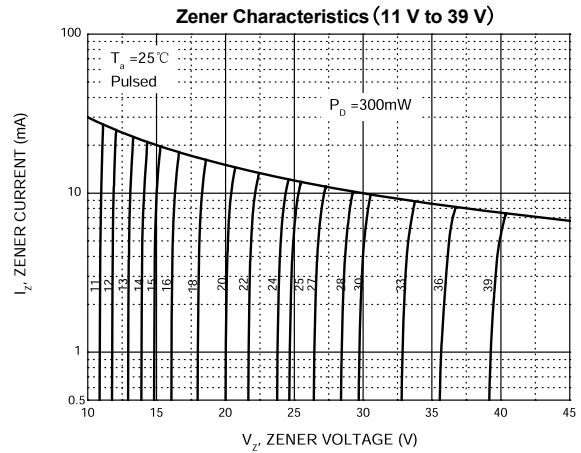
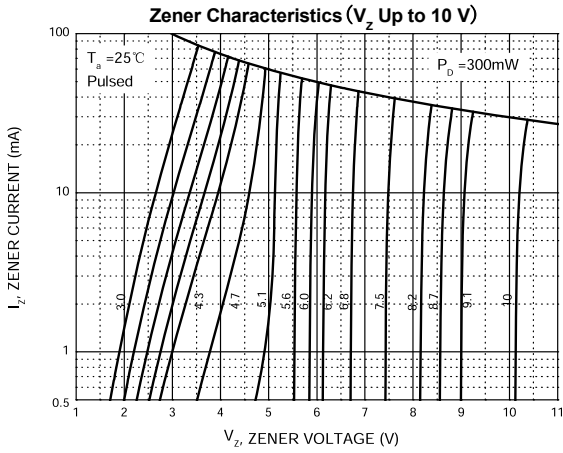

SOT-23 Package Outline Dimensions

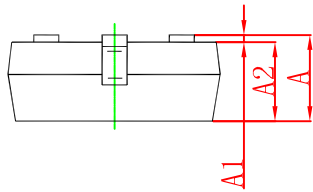
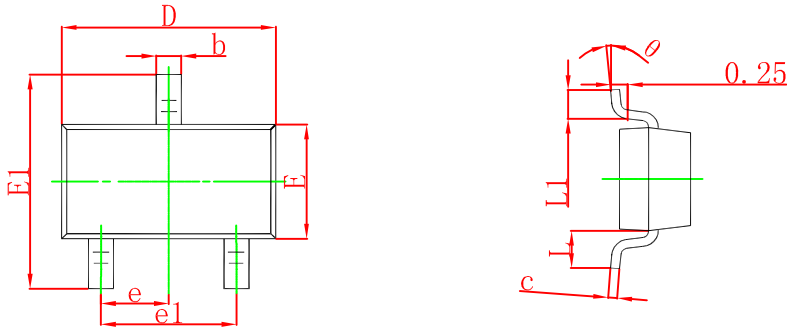

Symbol	Dimensions In Millimeters		Dimensions In Inches	
	Min	Max	Min	Max
A	0.900	1.150	0.035	0.045
A1	0.000	0.100	0.000	0.004
A2	0.900	1.050	0.035	0.041
b	0.300	0.500	0.012	0.020
c	0.080	0.150	0.003	0.006
D	2.800	3.000	0.110	0.118
E	1.200	1.400	0.047	0.055
E1	2.250	2.550	0.089	0.100
e	0.950 TYP		0.037 TYP	
e1	1.800	2.000	0.071	0.079
L	0.550 REF		0.022 REF	
L1	0.300	0.500	0.012	0.020
θ	0°	8°	0°	8°

SOT-23 Suggested Pad Layout

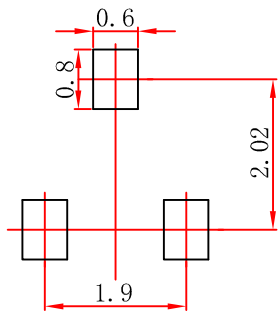

Note:

1. Controlling dimension: in millimeters.
2. General tolerance: $\pm 0.05\text{mm}$.
3. The pad layout is for reference purposes only.

SOT-23 Tape and Reel

SOT-23 Embossed Carrier Tape

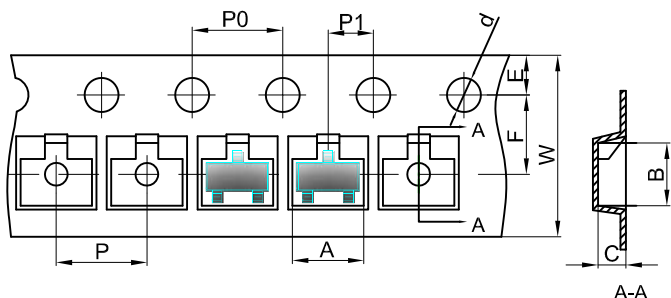

Packaging Description:

SOT-23 parts are shipped in tape. The carrier tape is made from a dissipative (carbon filled) polycarbonate resin. The cover tape is a multilayer film (Heat Activated Adhesive in nature) primarily composed of polyester film, adhesive layer, sealant, and anti-static sprayed agent. These reeled parts in standard option are shipped with 3,000 units per 7" or 17,8cm diameter reel. The reels are clear in color and is made of polystyrene plastic (anti-static coated).

Dimensions are in millimeter										
Pkg type	A	B	C	d	E	F	P0	P	P1	W
SOT-23	3,15	2,77	1,22	Ø1,50	1,75	3,50	4,00	4,00	2,00	8,00

SOT-23 Tape Leader and Trailer

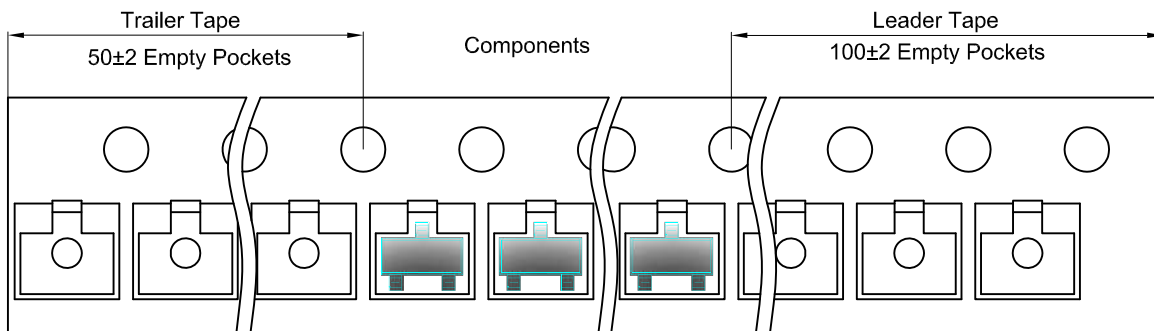

SOT-23 Reel

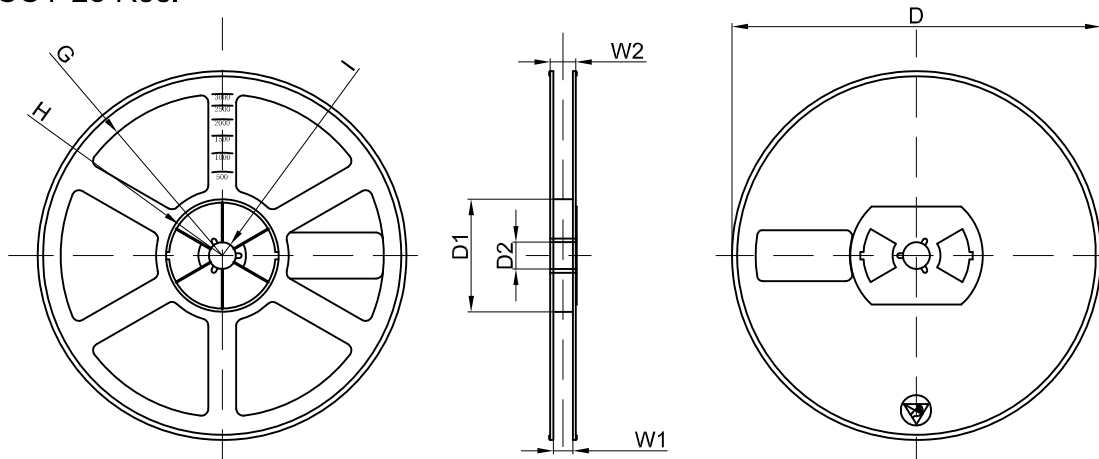

Dimensions are in millimeter								
Reel Option	D	D1	D2	G	H	I	W1	W2
7" Dia	Ø178.00	54.40	13.00	R78.00	R25.60	R6.50	9.50	12.30

REEL	Reel Size	Box	Box Size(mm)	Carton	Carton Size(mm)	G.W.(kg)
3000 pcs	7 inch	45,000 pcs	203×203×195	180,000 pcs	438×438×220	