

36V Low Current Consumption 300mA CMOS Voltage Regulator

The KNJ75LXXS series are a group of positive voltage regulators manufactured by CMOS technologies with low power consumption and low dropout voltage, which provide large output currents even when the difference of the input-output voltage is small.

The KNJ75LXXS series can deliver 300 mA output current and allow an input voltage as high as 36V. The series are very suitable for the battery powered equipments, such as RF applications and other systems requiring a quiet voltage source.

SOT-23

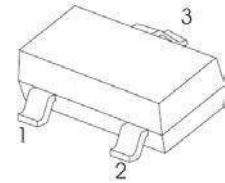

- 1.OUT
- 2.IN
- 3.GND

Features:

- Low Quiescent Current: 2 μ A
- Operating Voltage Range: 2.5V~36V
- Output Current: 300mA
- Low Dropout Voltage:
200mV@100mA($V_{OUT}=3.3V$)
- Output Voltage: 1.2~12V
- High Accuracy: $\pm 2\%$ (Typ.)
- High Power Supply Rejection Ratio:
70dB@1kHz
- Low Output Noise:
27x V_{OUT} μ V_{RMS}(10Hz~100kHz)
- Excellent Line and Load Transient Response
- Built-in Current Limiter, Short-Circuit Protection
- Over-Temperature Protection

Applications:

- Cordless Phones
- Radio control systems
- Laptop, Palmtops and PDAs
- Single-lens reflex DSC
- PC peripherals with memory
- Wireless Communication Equipments
- Portable Audio Video Equipments
- Car Navigation Systems
- LAN Cards
- Ultra Low Power Microcontrollers

BLOCK DIAGRAM

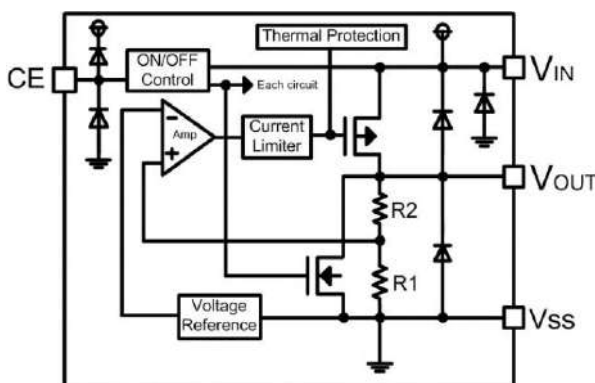

TYPICAL APPLICATION CIRCUIT

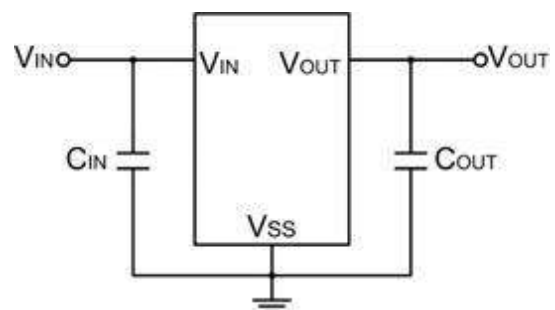

For KNJ75LXXS series, input and output capacitors are required to achieve stability and help the equipment obtain better transient response and PSRR. It is recommended to use 1 μ F input and 1 μ F output capacitors.

Electrical Characteristics

ABSOLUTE MAXIMUM RATINGS

(Unless otherwise specified, $T_A=25^{\circ}\text{C}$)

PARAMETER	SYMBOL	RATINGS	UNITS
Input Voltage ⁽²⁾	V_{IN}	-0.3~40	V
Output Voltage ⁽²⁾	V_{OUT}	-0.3~13	V
Power Dissipation	P_D	0.6	W
Operating Ambient Temperature Range	T_A	-40~+85	$^{\circ}\text{C}$
Operating Junction Temperature Range ⁽³⁾	T_j	-40~+125	$^{\circ}\text{C}$
Storage Temperature	T_{stg}	-40~+125	$^{\circ}\text{C}$
Lead Temperature(Soldering, 10 sec)	T_{solder}	260	$^{\circ}\text{C}$
ESD rating	Human Body Model -(HBM)	2	kV
	Machine Model- (MM)	200	V

(1) Stresses beyond those listed under *absolute maximum ratings* may cause permanent damage to the device. These are stress ratings only, and functional operation of the device at these or any other conditions beyond those indicated under *recommended operating conditions* is not implied. Exposure to absolute-maximum-rated conditions for extended periods may affect device reliability.

(2) All voltages are with respect to network ground terminal.

(3) This IC includes over temperature protection that is intended to protect the device during momentary overload. Junction temperature will exceed 125°C when over temperature protection is active. Continuous operation above the specified maximum operating junction temperature may impair device reliability.

RECOMMENDED OPERATING CONDITIONS

PARAMETER	MIN.	NOM.	MAX.	UNITS
Supply voltage at V_{IN}	2.5		36	V
Operating junction temperature range, T_j	-40		125	$^{\circ}\text{C}$
Operating free air temperature range, T_A	-40		85	$^{\circ}\text{C}$

ELECTRICAL CHARACTERISTICS

(Unless otherwise specified, TA=25°C)

PARAMETER	SYMBOL	CONDITIONS	MIN.	TYP. ⁽⁴⁾	MAX.	UNITS	
Input Voltage	V _{IN}		2.5	—	36	V	
Output Voltage Range	V _{OUT}		2.1	—	12	V	
DC Output Accuracy		I _{OUT} =1mA	-2	—	2	%	
Dropout Voltage	V _{dif} ⁽⁵⁾	I _{OUT} =100mA, V _{OUT} =3.3V	—	200	—	mV	
Supply Current	I _{SS}	I _{OUT} =0A	1.2≤V _{OUT} ≤7.0V	—	2	5	μA
			7.0<V _{OUT} ≤12V	—	3	6	μA
Line Regulation	$\frac{\Delta V_{OUT}}{V_{OUT} \times \Delta V_{IN}}$	I _{OUT} =10mA V _{OUT} +1V≤V _{IN} ≤36V	—	0.01	0.3	%/V	
Load Regulation	$\frac{\Delta V_{OUT}}{I_{OUT}}$	V _{IN} =V _{OUT} +1V, 1mA≤I _{OUT} ≤100mA	—	10	—	mV	
Temperature Coefficient	$\frac{\Delta V_{OUT}}{V_{OUT} \times \Delta T_A}$	I _{OUT} =10mA, -40°C<T _J <125°C	—	50	—	ppm	
Output Current Limit	I _{LIM}	V _{OUT} =0.5 × V _{OUT(Normal)} · V _{in} =5.0V	350	600	—	mA	
Short Current	I _{SHORT}	V _{OUT} =V _{SS}	—	100	—	mA	
Power Supply Rejection Ratio	PSRR	I _{OUT} =50mA	100Hz	—	75	—	dB
			1kHz	—	70	—	
			10kHz	—	55	—	
			100kHz	—	40	—	
Output Noise Voltage	V _{ON}	BW=10Hz to 100kHz	—	27 × V _{OUT}	—	μV _{RMS}	
Thermal Shutdown Temperature	T _{SD}	—	—	160	—	°C	
Thermal Shutdown Hysteresis	ΔT _{SD}	—	—	20	—	°C	

(4) Typical numbers are at 25°C and represent the most likely norm.

(5) V_{dif}: The Difference Of Output Voltage And Input Voltage When Input Voltage Is Decreased Gradually Till Output Voltage Equals To 98% Of V_{OUT} (E).

MODEL DEFINITION INFORMATION

Model	Output Voltage
KNJ75L033S	3.3V
KNJ75L05S	5.0V
KNJ75LC0S	12.0V

Typical Characteristics

(Unless otherwise specified, $T_A=25^\circ\text{C}$)

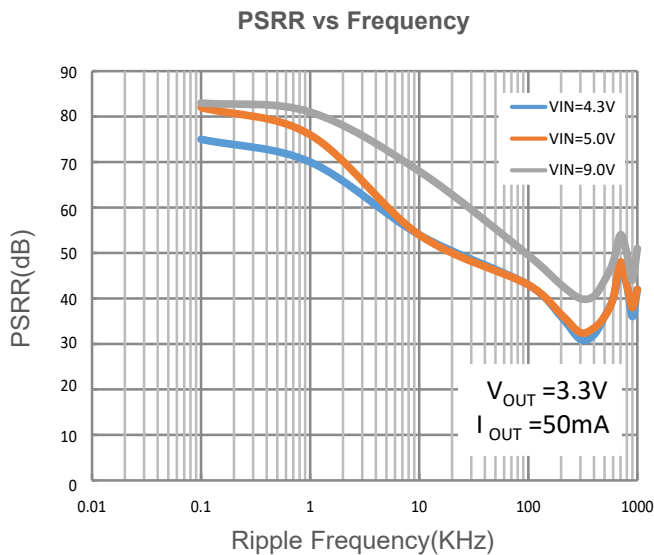
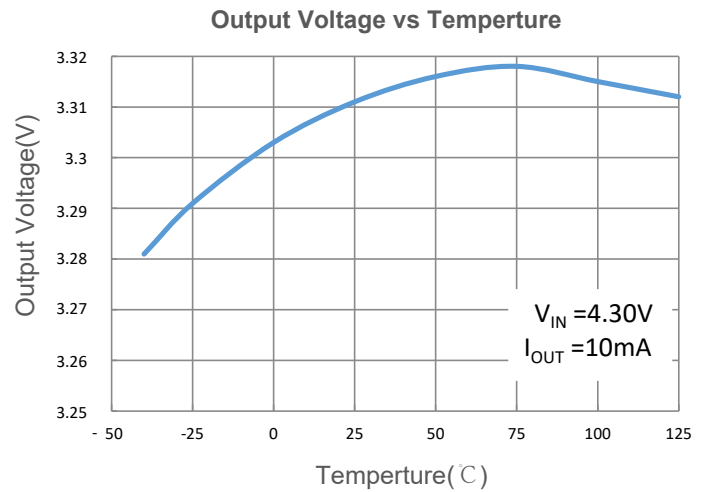
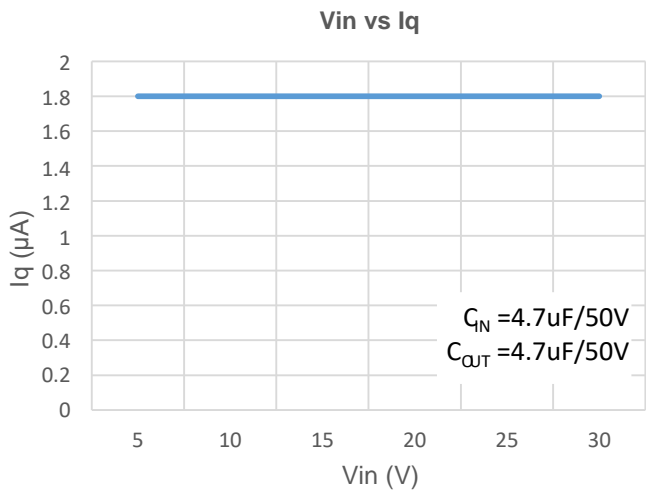
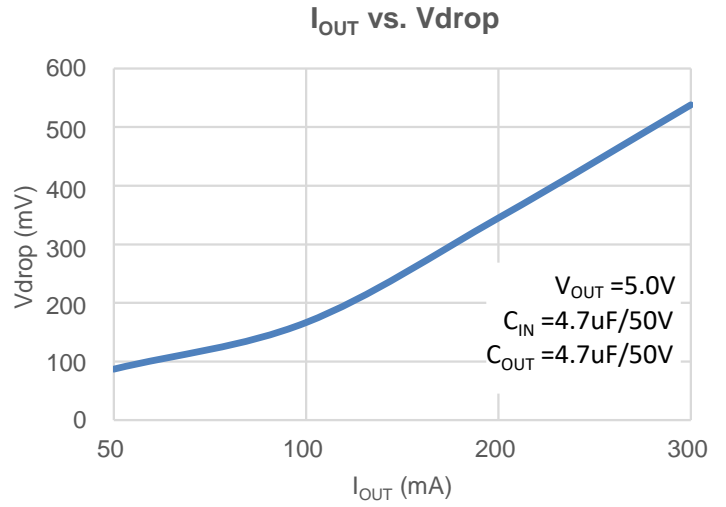
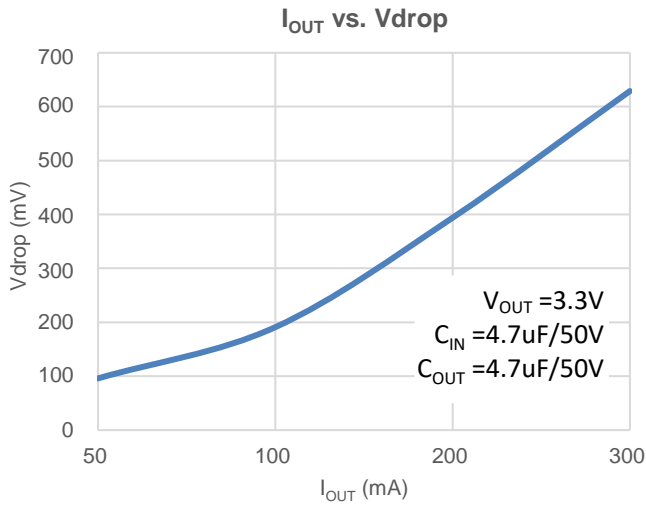

Typical Characteristics

(Unless otherwise specified, $T_A=25^\circ\text{C}$)

Power Up Response

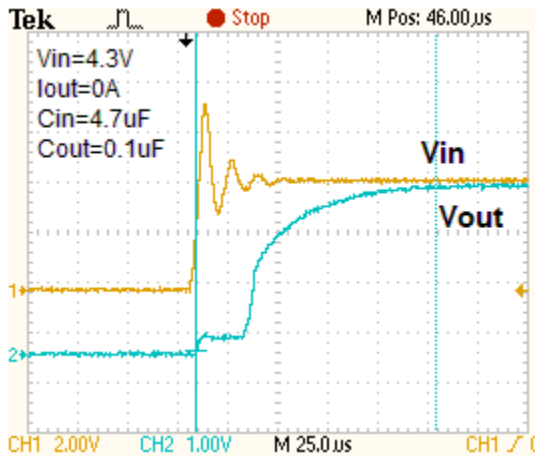

Power Up Response

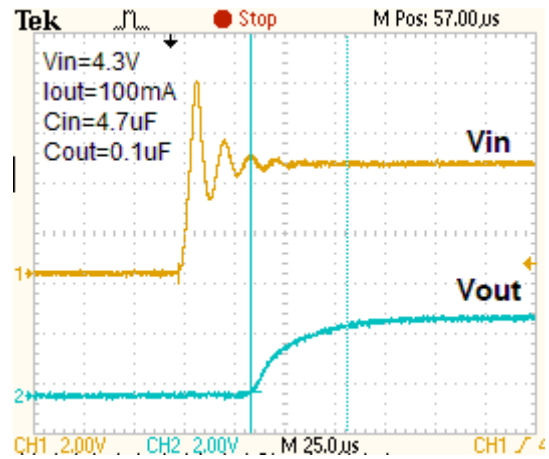

Load Transient Response

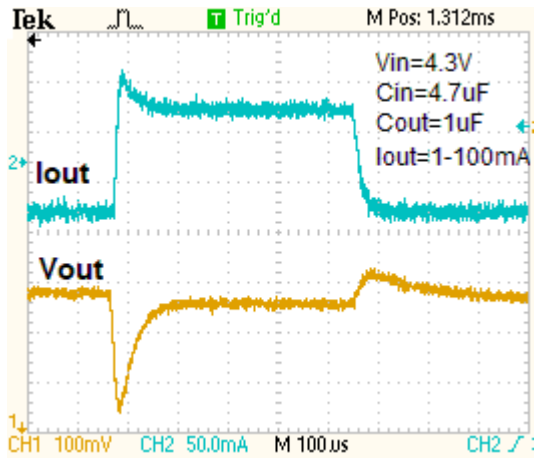

Load Transient Response

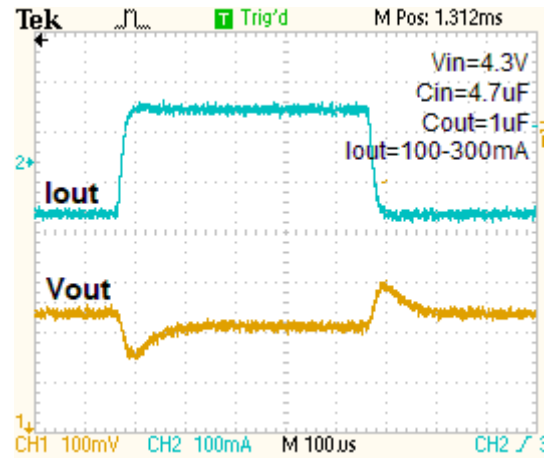

SOT-23 Package Outline Dimensions

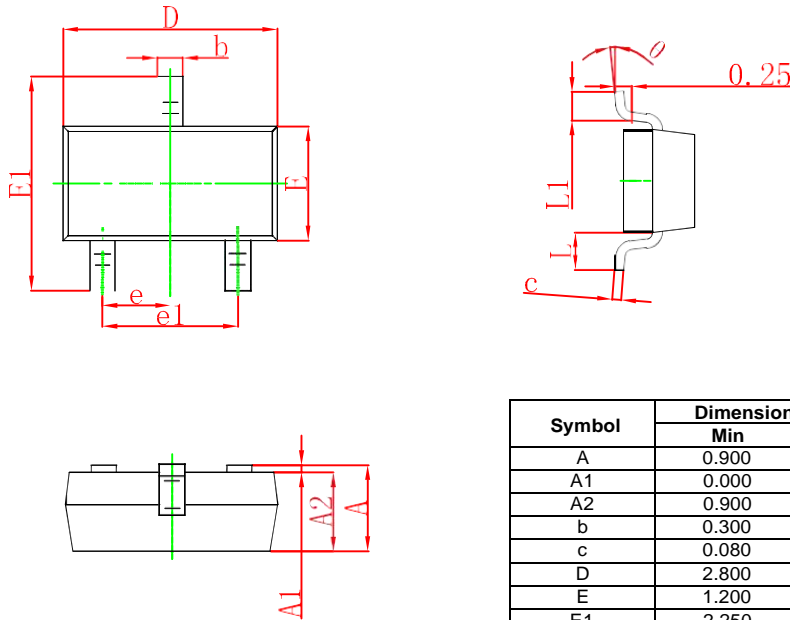

Symbol	Dimensions In Millimeters		Dimensions In Inches	
	Min	Max	Min	Max
A	0.900	1.150	0.035	0.045
A1	0.000	0.100	0.000	0.004
A2	0.900	1.050	0.035	0.041
b	0.300	0.500	0.012	0.020
c	0.080	0.150	0.003	0.006
D	2.800	3.000	0.110	0.118
E	1.200	1.400	0.047	0.055
E1	2.250	2.550	0.089	0.100
e	0.950 TYP		0.037 TYP	
e1	1.800	2.000	0.071	0.079
L	0.550 REF		0.022 REF	
L1	0.300	0.500	0.012	0.020
θ	0°	8°	0°	8°

SOT-23 Suggested Pad Layout

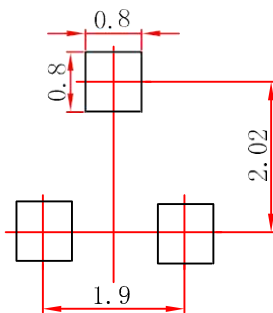

Note:
 1. Controlling dimension: In millimeters.
 2. General tolerance: ± 0.05 mm.
 3. The pad layout is for reference purposes only.