

SOD-123 Plastic-Encapsulate Diodes

Features:

- High Voltage

MARKING: 5D



SOD-123

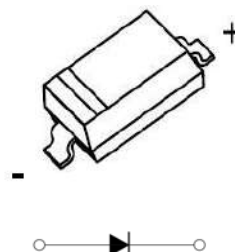

MAXIMUM RATINGS ($T_a=25^{\circ}\text{C}$ unless otherwise noted)

Symbol	Parameter	Value	Unit
V_{RRM}	Maximum Repetitive Reverse Voltage	100	V
I_o	Forward Current	0.2	A
I_{FSM}	Non-repetitive Peak Forward Surge Current @ $t=8.3\text{ms}$	2	
P_D	Power Dissipation	400	mW
$R_{\theta JA}$	Thermal Resistance from Junction to Ambient	312	$^{\circ}\text{C/W}$
T_j, T_{stg}	Operation Junction and Storage Temperature Range	-55~+150	$^{\circ}\text{C}$

ELECTRICAL CHARACTERISTICS($T_a=25^{\circ}\text{C}$ unless otherwise specified)

Parameter	Symbol	Test conditions	Min	Typ	Max	Unit
Reverse voltage	$V_{(BR)}$	$I_R=100\mu\text{A}$	100			V
Reverse current	I_R	$V_R=20\text{V}$			25	nA
		$V_R=75\text{V}$			5	μA
Forward voltage	V_F	$I_F=10\text{mA}$			1	V
Total capacitance	C_{tot}	$V_R=0\text{V}, f=1\text{MHz}$			4	pF
Reverse recovery time	t_{rr}	$I_F=I_R=10\text{mA}, I_{rr}=0.1 \times I_R, R_L=100\Omega$			4	ns

Typical Characteristics

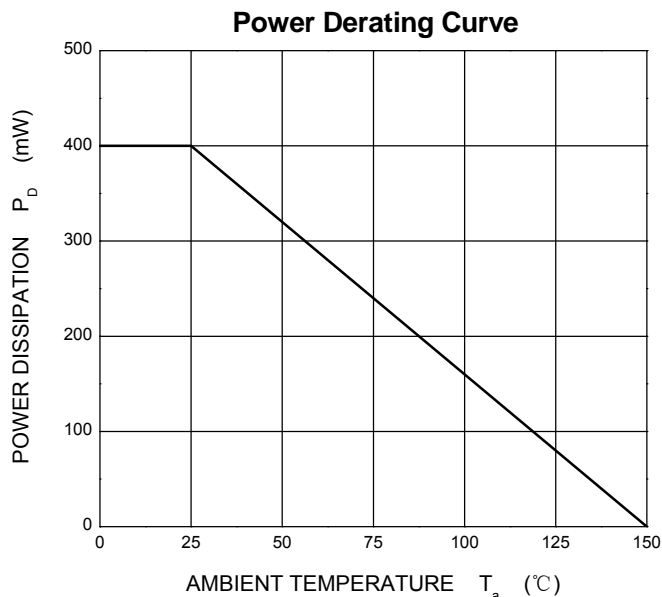
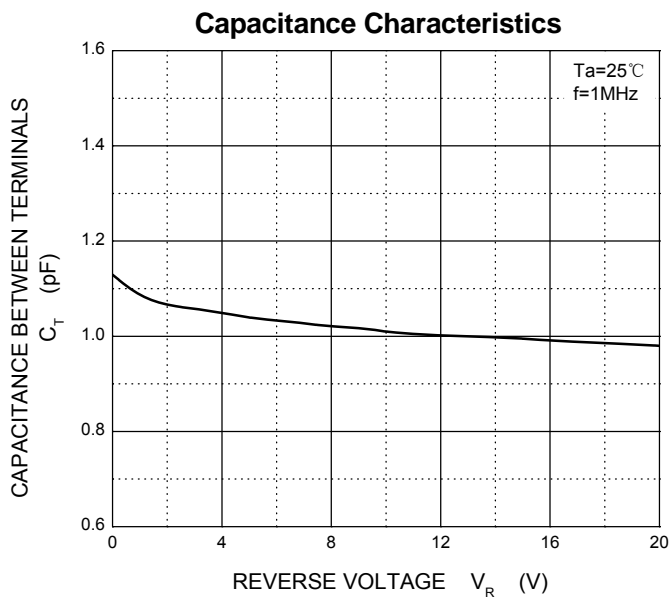
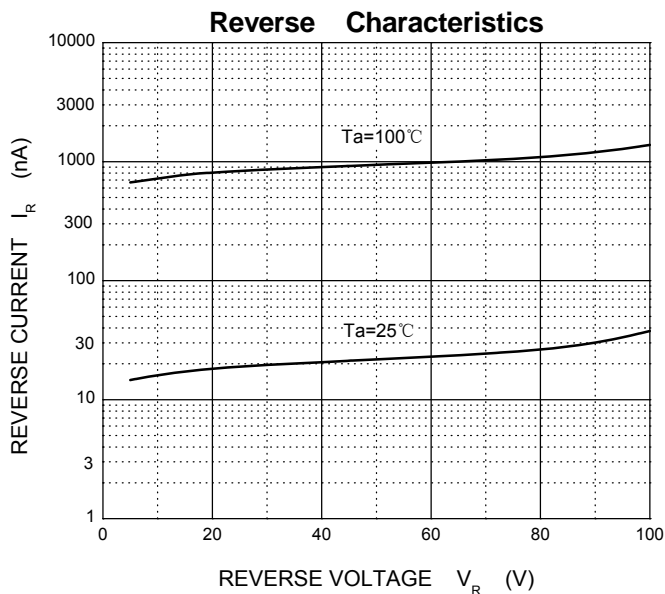
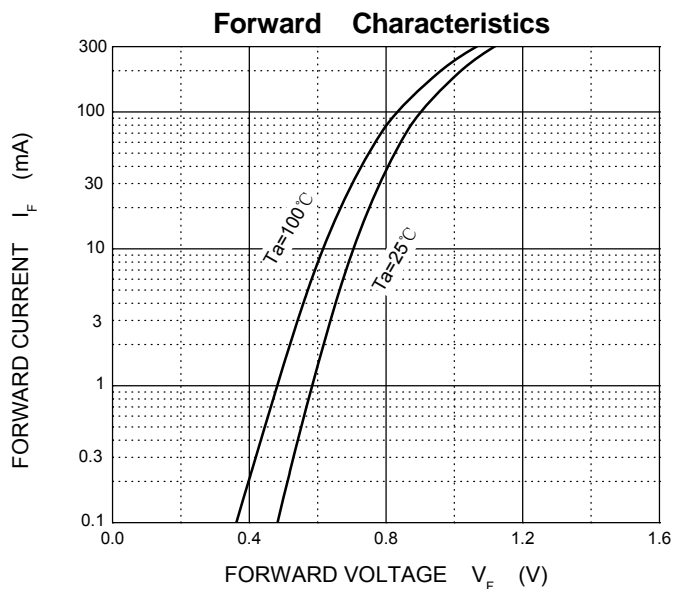

SOD-123 Package Outline Dimensions

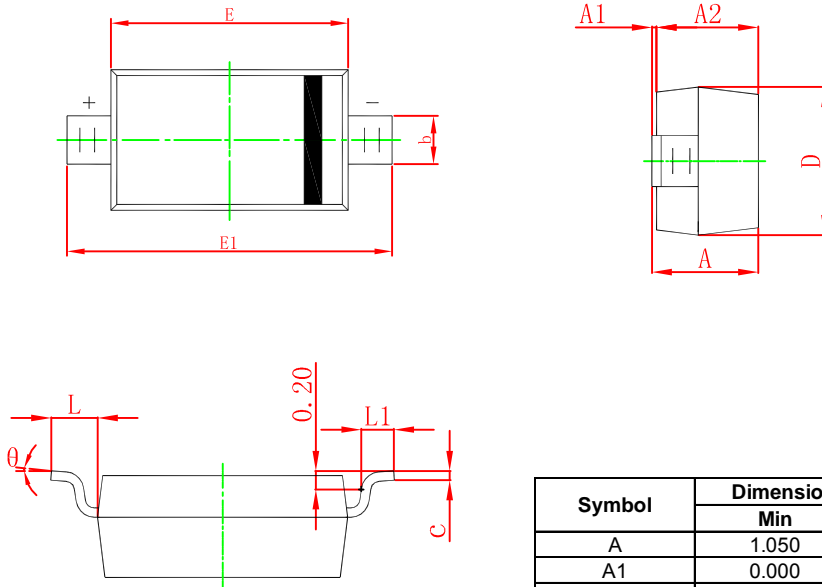

Symbol	Dimensions In Millimeters		Dimensions In Inches	
	Min	Max	Min	Max
A	1.050	1.250	0.041	0.049
A1	0.000	0.100	0.000	0.004
A2	1.050	1.150	0.041	0.045
b	0.450	0.650	0.018	0.026
c	0.080	0.150	0.003	0.006
D	1.500	1.700	0.059	0.067
E	2.600	2.800	0.102	0.110
E1	3.550	3.850	0.140	0.152
L	0.500 REF		0.020 REF	
L1	0.250	0.450	0.010	0.018
θ	0°	8°	0°	8°

SOD-123 Suggested Pad Layout

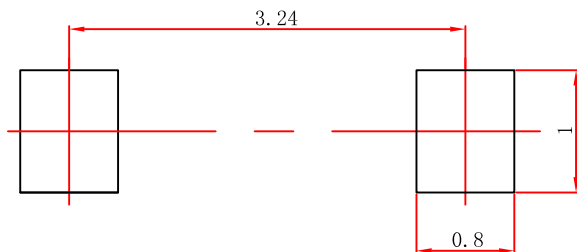

- Note:**
1. Controlling dimension: in millimeters.
 2. General tolerance: ± 0.05 mm.
 3. The pad layout is for reference purposes only.

SOD-123 Tape and Reel

SOD-123 Embossed Carrier Tape

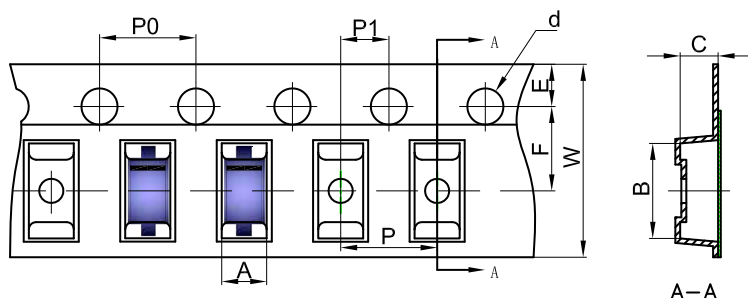

Packaging Description:

SOD-123 parts are shipped in tape. The carrier tape is made from a dissipative (carbon filled) polycarbonate resin. The cover tape is a multilayer film (Heat Activated Adhesive in nature) primarily composed of polyester film, adhesive layer, sealant, and anti-static sprayed agent. These reeled parts in standard option are shipped with 3,000 units per 7" or 17.8cm diameter reel. The reels are clear in color and is made of polystyrene plastic (anti-static coated).

Dimensions are in millimeter										
Pkg type	A	B	C	d	E	F	P0	P	P1	W
SOD-123	1.85	3.95	1.57	Ø1.55	1.75	3.50	4.00	4.00	2.00	8.00

SOD-123 Tape Leader and Trailer

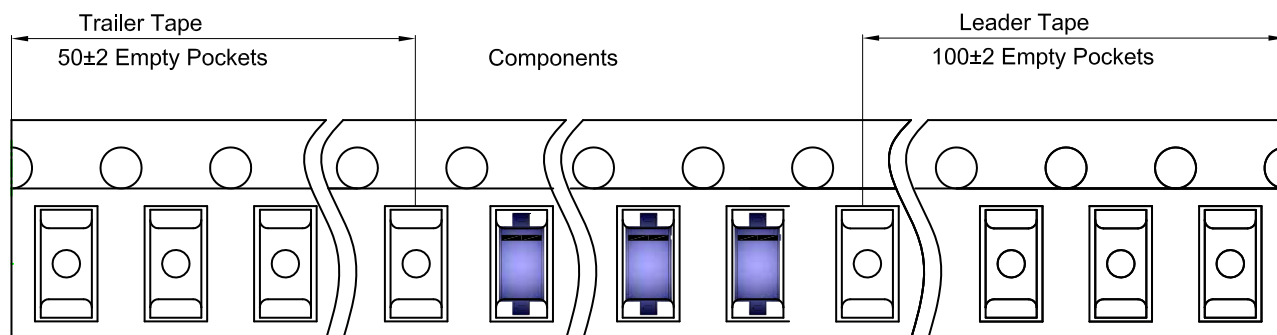

SOD-123 Reel

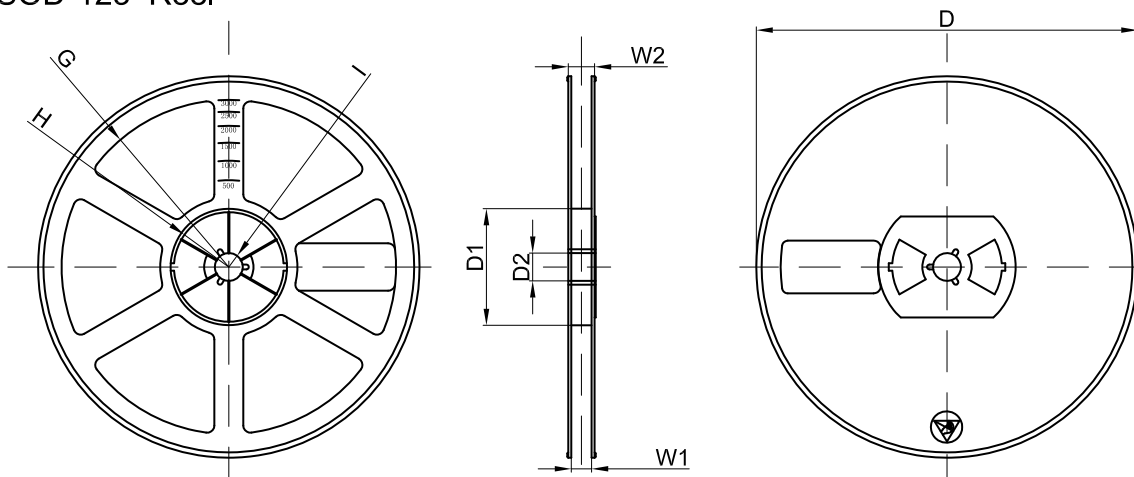

Dimensions are in millimeter								
Reel Option	D	D1	D2	G	H	I	W1	W2
7"Dia	Ø178.00	54.40	13.00	R78.00	R25.60	R6.50	9.50	12.30

REEL	Reel Size	Box	Box Size(mm)	Carton	Carton Size(mm)	G.W.(kg)
3000 pcs	7 inch	45,000 pcs	203×203×195	180,000 pcs	438×438×220	