

FAST RECOVERY SURFACE MOUNT GLASS PASSIVATED BRIDGE RECTIFIER

Features:

- Glass Passivated Die Construction
- Low Forward Voltage Drop
- High Current Capability
- High Surge Current Capability
- Designed for Surface Mount Application
- Plastic Material – UL Flammability 94V-0

Mechanical Data:

- Case: SOPA-4, ABS, Molded Plastic
- Terminals: Plated Leads Solderable per MIL-STD-202, Method 208
- Polarity: As Marked on Case
- Mounting Position: Any
- Marking: Type Number
- **Lead Free: For RoHS / Lead Free Version**

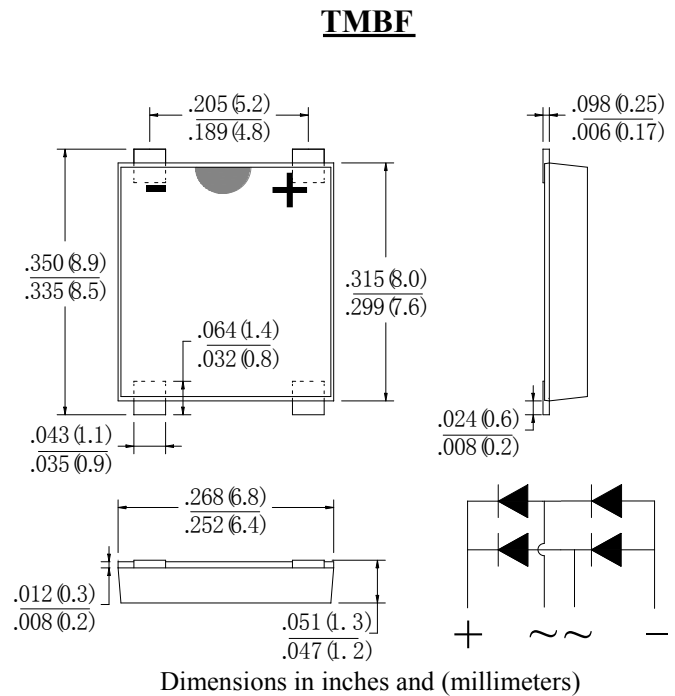

Maximum Ratings and Electrical Characteristics @T_Aerwise specified

Single Phase, half wave, 60Hz, resistive or inductive load.
 For capacitive load, derate current by 20%.

Characteristic	Symbol	RTMBF	RTMBF	RTMBF	RTMBF	RTMBF	RTMBF	RTMBF	Unit
		305	31	32	34	36	38	310	
Peak Repetitive Reverse Voltage	V _{RRM}								V
Working Peak Reverse Voltage	V _{RW}	50	100	200	400	600	800	1000	
DC Blocking Voltage	M _{VR}								
RMS Reverse Voltage	V _{R(RMS)}	35	70	140	280	420	560	700	V
Average Rectified Output Current (Note 1) @T _A = 40°C	I _O	3.0							A
Average Rectified Output Current (Note 2) @T _A = 40°C									
Non-Repetitive Peak Forward Surge Current 8.3ms Single half sine-wave superimposed on rated load (JEDEC Method)	I _{FSM}	150							A
I ² t Rating for Fusing (t < 8.3ms)	I ² t	5.0							A ² s
Forward Voltage per element @I _F = 4.0A	V _{FM}	1.25							V
Peak Reverse Current @T _A = 25°C At Rated DC Blocking Voltage @T _A = 125°C	I _{RM}	5.0 200							μA
Reverse Recovery Time (Note 4)	t _{rr}	150				250			nS
Typical Junction Capacitance per leg (Note 3)	C _j	13							pF
Typical Thermal Resistance per leg (Note 1)	R _{θJA} R _{θJL}	62.5 25							°C/W
Operating and Storage Temperature Range	T _j , T _{STG}	-55 to +150							°C

Note: 1. Mounted on glass epoxy PC board with 1.3mm² solder pad.
 2. Mounted on aluminum substrate PC board with 1.3mm² solder pad.
 3. Measured at 1.0 MHz and applied reverse voltage of 4.0V D.C.
 4. Measured with I_F = 0.5A, I_R = 1.0A, I_{RR} = 0.25A. See figure 5.

RTMBF305 – RTMBF310

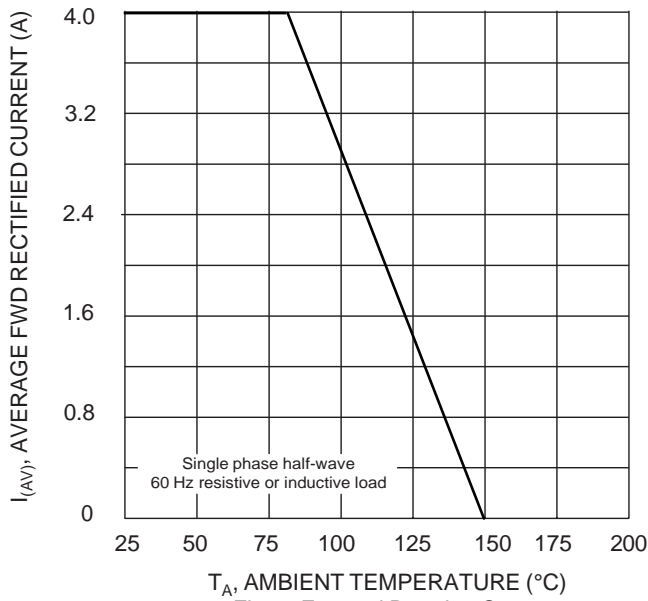

Fig. 1 Forward Derating Curve

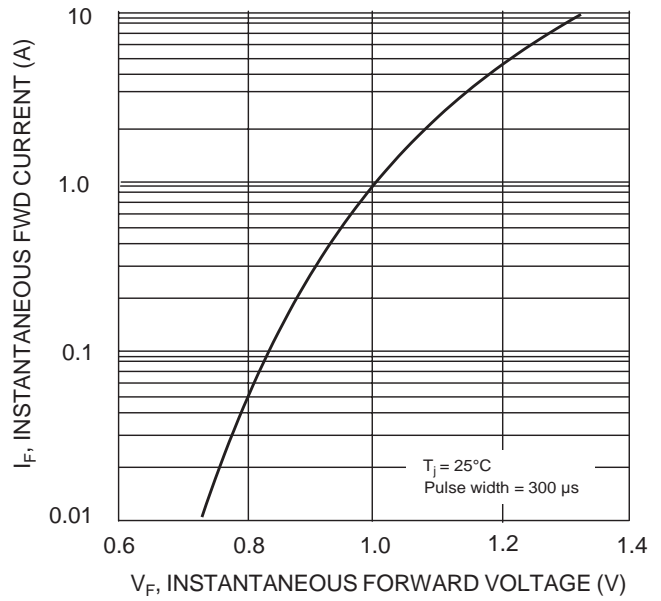

Fig. 2 Typical Forward Characteristics

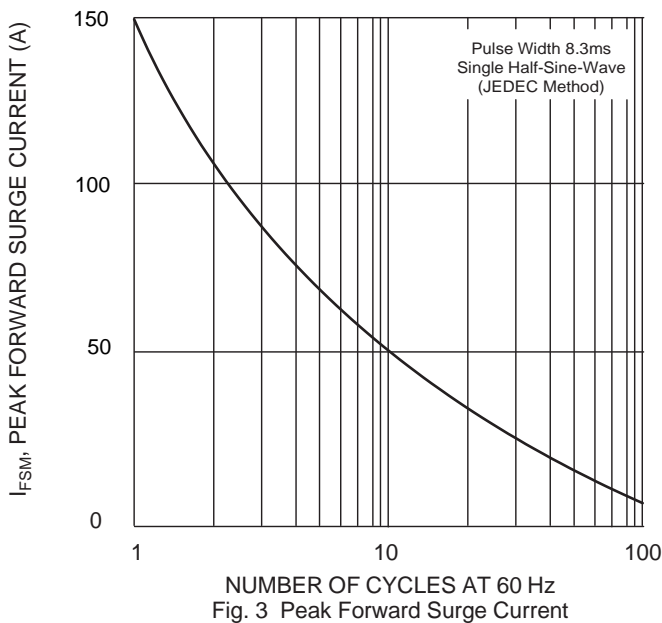

Fig. 3 Peak Forward Surge Current

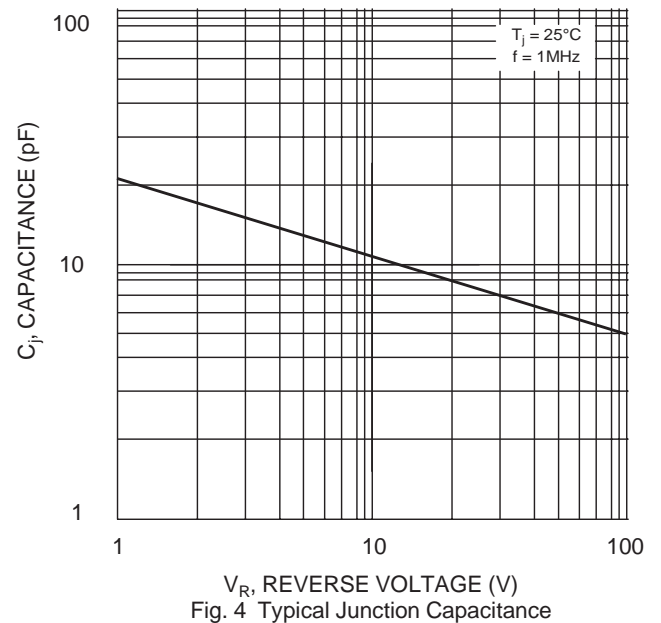
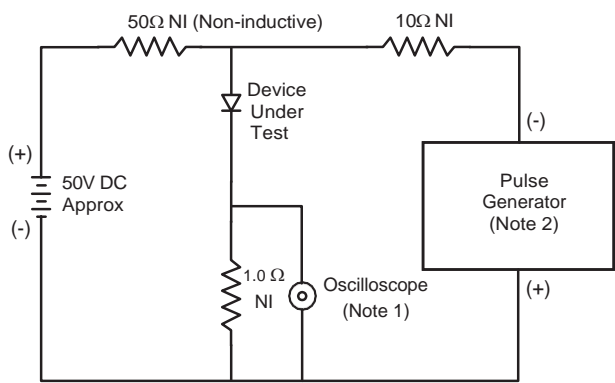
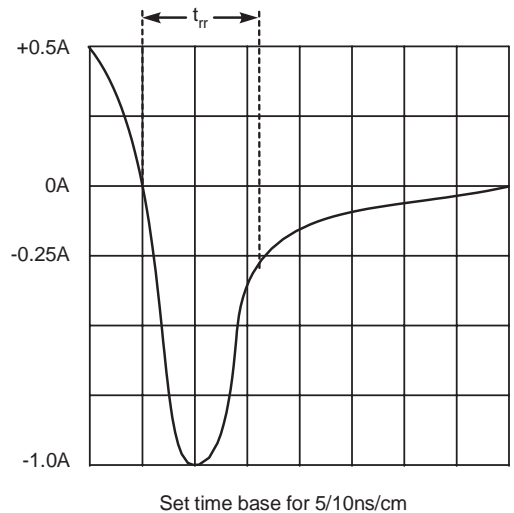

Fig. 4 Typical Junction Capacitance



- Notes:
 1. Rise Time = 7.0ns max. Input Impedance = 1.0MΩ, 22pF.
 2. Rise Time = 10ns max. Input Impedance = 50Ω.



5 Reverse Recovery Time Characteristic and Test Circuit