

**FAST RECOVERY SURFACE MOUNT GLASS PASSIVATED BRIDGE RECTIFIER**

**Features:**

- Glass Passivated Die Construction
- Low Forward Voltage Drop
- High Current Capability
- High Surge Current Capability
- Designed for Surface Mount Application
- Plastic Material – UL Flammability 94V-O

**Mechanical Data:**

- Case: SOPA-4, ABS, Molded Plastic
- Terminals: Plated Leads Solderable per **MIL-STD-202, Method 208**
- Polarity: As Marked on Case
- Mounting Position: Any
- Marking: Type Number
- **Lead Free: For RoHS / Lead Free Version**

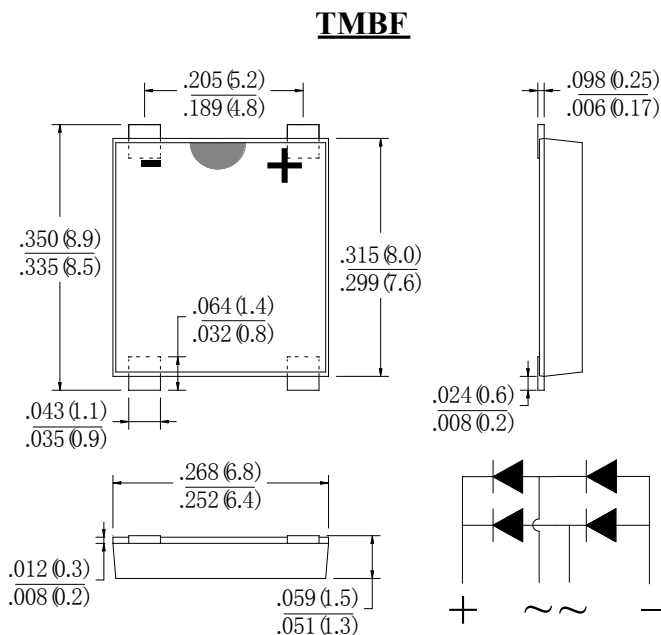

Dimensions in inches and (millimeters)

**Maximum Ratings and Electrical Characteristics** @T<sub>A</sub>erwise specified

Single Phase, half wave, 60Hz, resistive or inductive load.  
 For capacitive load, derate current by 20%.

Characteristic	Symbol	RTMBF	RTMBF	RTMBF	RTMBF	RTMBF	RTMBF	RTMBF	Unit
		1505	151	152	154	156	158	1510	
Peak Repetitive Reverse Voltage Working Peak Reverse Voltage DC Blocking Voltage	V <sub>RRM</sub> V <sub>RWM</sub> V <sub>R</sub>	50	100	200	400	600	800	1000	V
RMS Reverse Voltage	V <sub>R(RMS)</sub>	35	70	140	280	420	560	700	V
Average Rectified Output Current (Note 1) @T <sub>A</sub> = 40°C Average Rectified Output Current (Note 2) @T <sub>A</sub> = 40°C	I <sub>O</sub>	1.5							A
Non-Repetitive Peak Forward Surge Current 8.3ms Single half sine-wave superimposed on rated load (JEDEC Method)	I <sub>FSM</sub>	75							A
I <sup>2</sup> t Rating for Fusing (t < 8.3ms)	I <sup>2</sup> t	5.0							A <sup>2</sup> s
Forward Voltage per element @I <sub>F</sub> = 1.5A	V <sub>FM</sub>	1.25							V
Peak Reverse Current @T <sub>A</sub> = 25°C At Rated DC Blocking Voltage @T <sub>A</sub> = 125°C	I <sub>RM</sub>	5.0 500							µA
Reverse Recovery Time (Note 4)	t <sub>rr</sub>	150			250		500		nS
Typical Junction Capacitance per leg (Note 3)	C <sub>j</sub>	13							pF
Typical Thermal Resistance per leg (Note 1)	R <sub>θJA</sub> R <sub>θJL</sub>	50 10							°C/W
Operating and Storage Temperature Range	T <sub>j</sub> , T <sub>STG</sub>	-55 to +150							°C

Note: 1. Mounted on glass epoxy PC board with 1.3mm<sup>2</sup> solder pad.  
 2. Mounted on aluminum substrate PC board with 1.3mm<sup>2</sup> solder pad.  
 3. Measured at 1.0 MHz and applied reverse voltage of 4.0V D.C.  
 4. Measured with I<sub>F</sub> = 0.5A, I<sub>R</sub> = 1.0A, I<sub>RR</sub> = 0.25A. See figure 5.

**RTMBF1505 – RTMBF1510**

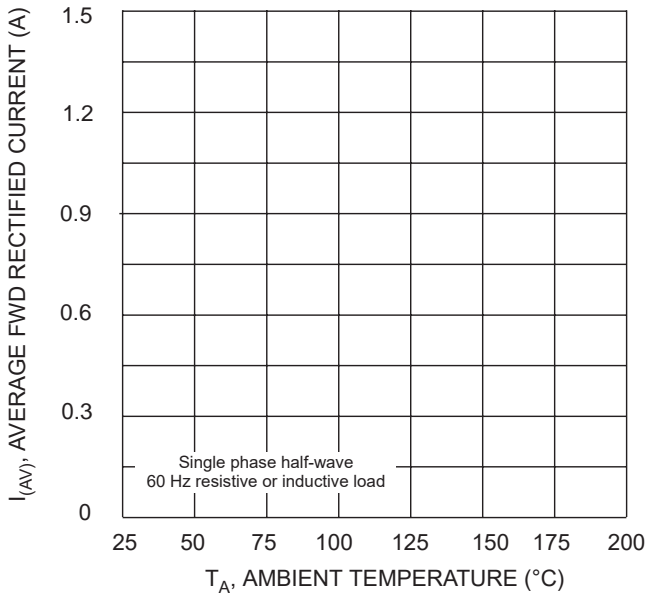

Fig. 1 Forward Derating Curve

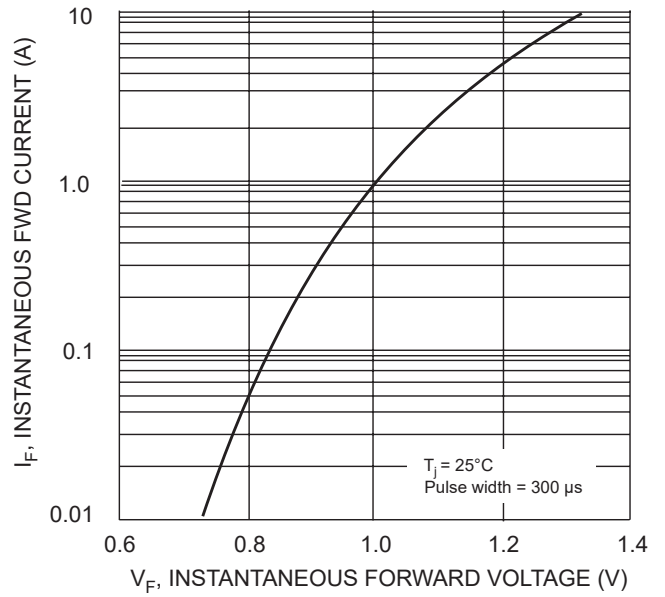

Fig. 2 Typical Forward Characteristics

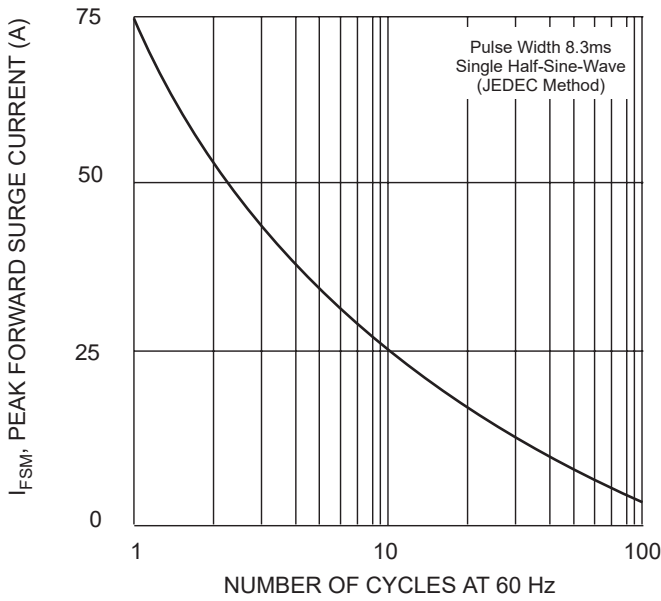

Fig. 3 Peak Forward Surge Current

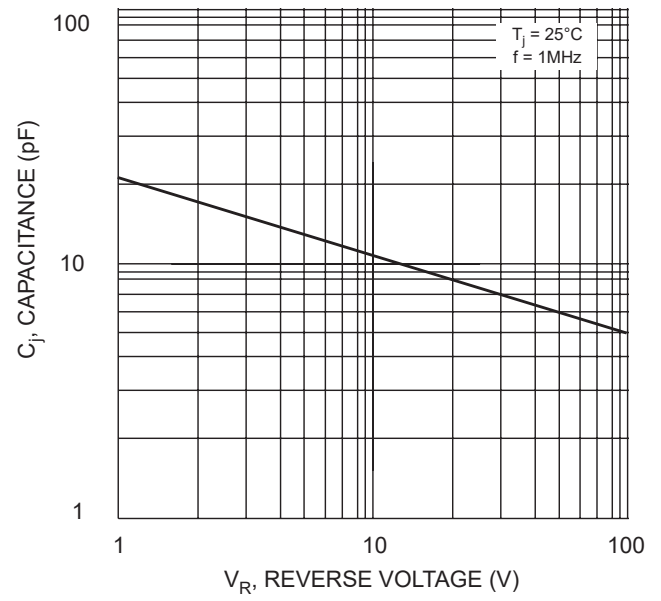
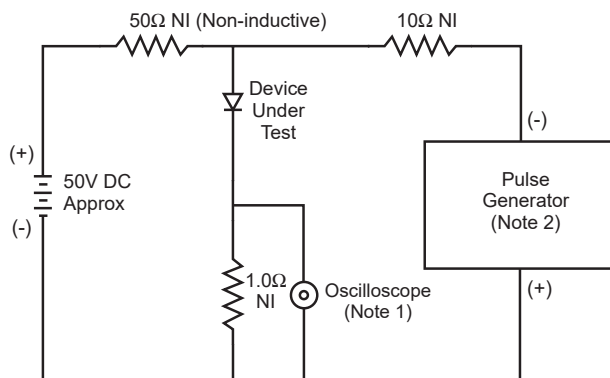
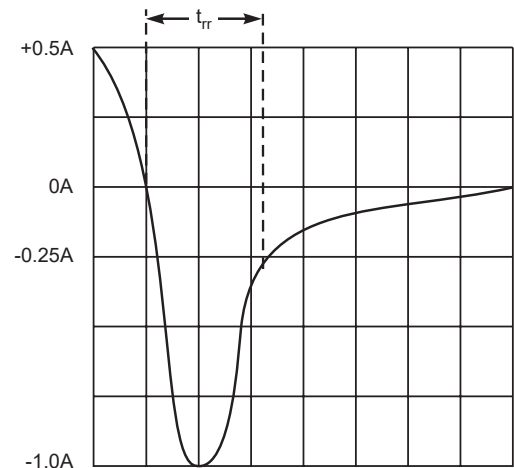

Fig. 4 Typical Junction Capacitance



- Notes:  
 1. Rise Time = 7.0ns max. Input Impedance = 1.0MΩ, 22pF.  
 2. Rise Time = 10ns max. Input Impedance = 50Ω.



Set time base for 5/10ns/cm

**5 Reverse Recovery Time Characteristic and Test Circuit**