

TO- 277 Plastic-Encapsulate Diodes

Schottky Rectifier Diode

Features:

- $I_{F(AV)}$ 8A
- V_{RRM} 100V
- High surge current capability
- Low peak forward voltage

Applications:

- Rectifier

Marking

- SB8100

TO-277

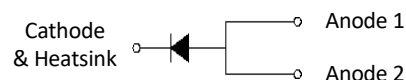
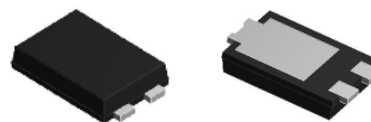

Limiting Values(Absolute Maximum Rating)

Item	Symbol	Unit	Test Conditions	KSB8100
Repetitive Peak Reverse Voltage	V_{RRM}	V		100
Maximum RMS Voltage	V_{RMS}	V		70
Average Forward Current	$I_{F(AV)}$	A	60Hz Half-sine wave · Resistance load · TL(Fig.1)	8
Surge(Non-repetitive)Forward Current	I_{FSM}	A	60Hz Half-sine wave · 1 cycle · $T_a=25^{\circ}C$	150
Junction Temperature	T_J	$^{\circ}C$		-55 ~ +150
Storage Temperature	T_{STG}	$^{\circ}C$		-55 ~ +150

Electrical Characteristics (T=25 $^{\circ}C$ Unless otherwise specified)

Item	Symbol	Unit	Test Condition		KSB8100	
Peak Forward Voltage	V_F	V	$I_F = 8.0A$	$T_a = 25^{\circ}C$	0.78(TYP)	0.85(MAX)
				$T_a = 125^{\circ}C$	0.65(TYP)	0.74(MAX)
Peak Reverse Current	I_{RRM1}	mA	$V_{RM} = V_{RRM}$	$T_a = 25^{\circ}C$	0.02(TYP)	0.08(MAX)
	I_{RRM2}			$T_a = 125^{\circ}C$	10(TYP)	20(MAX)
Thermal Resistance(Typical)	$R_{\theta J-A}$	$^{\circ}C/W$	Between junction and ambient		80	
	$R_{\theta J-L}$		Between junction and terminal		10	
Typical junction capacitance	C_J	nF	$V_R = 4.0 V, f = 1 MHz$		0.95	

Notes:

Thermal resistance from junction to ambient and from junction to lead mounted on P.C.B. with 0.3" x 0.3" (8.0 mm x 8.0 mm) copper pad areas

Typical Characteristics

FIG.1: FORWARD CURRENT DERATING CURVE

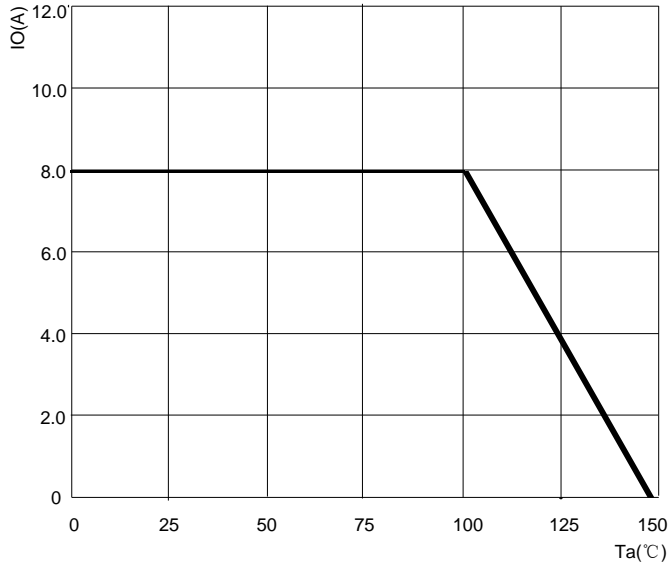

FIG.2: MAXIMUM NON-REPETITIVE FORWARD SURGE CURRENT

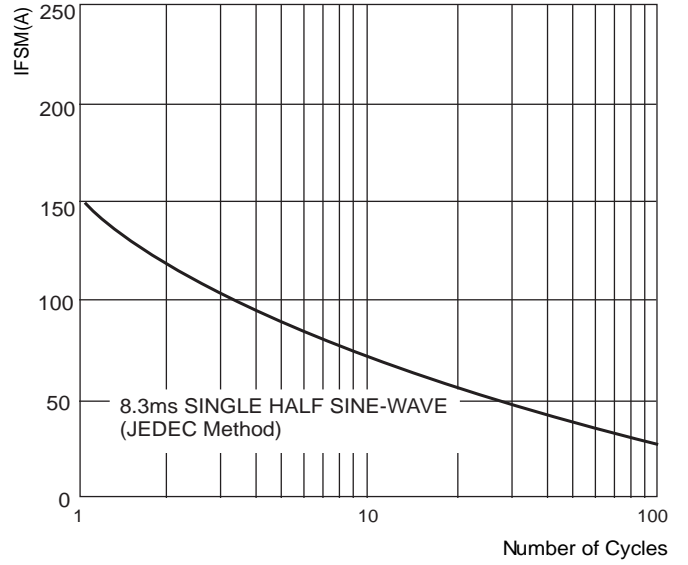

FIG.3: INSTANTANEOUS FORWARD CHARACTERISTICS

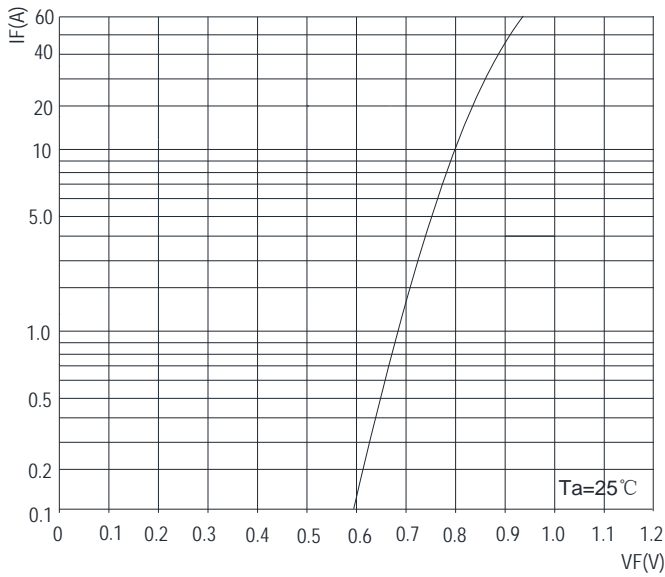
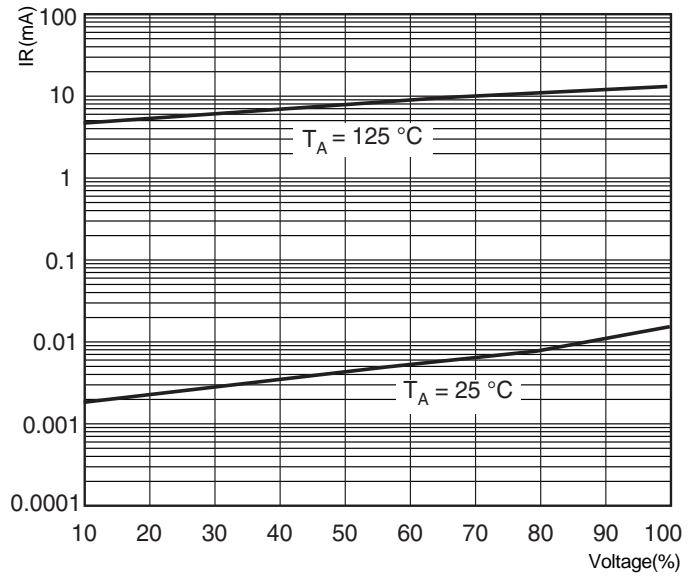
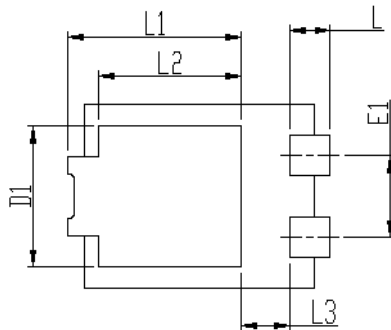
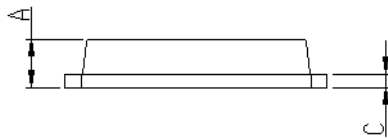
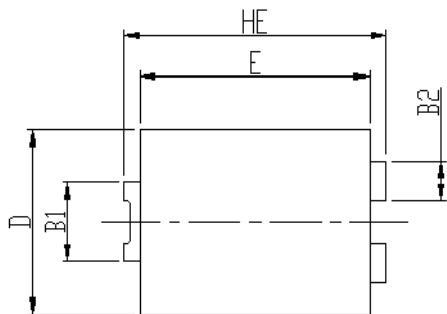

FIG.4: TYPICAL REVERSE CHARACTERISTICS



TO- 277 Package Outline Dimensions



DIM	Unit: mm		Unit: inch	
	MIN	MAX	MIN	MAX
HE	6.4	6.6	0.252	0.260
E	5.6	5.8	0.220	0.228
D	4.1	4.3	0.161	0.169
B1	1.7	1.9	0.067	0.075
B2	0.8	1	0.031	0.039
A	1.05	1.2	0.041	0.047
C	0.3	0.4	0.012	0.016
L	0.85	1.1	0.033	0.043
L1	4.2	4.4	0.165	0.173
L2	3.52 Typ.		0.139 Typ.	
L3	1.1	1.4	0.043	0.055
D1	3	3.3	0.118	0.130
E1	1.86 Typ.		0.073 Typ.	

TO- 277 Suggested Pad Layout

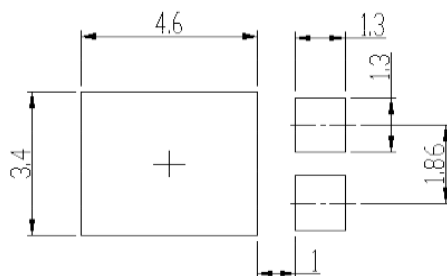

Note:

1. Controlling dimension: in millimeters.
2. General tolerance: $\pm 0.05\text{mm}$.
3. The pad layout is for reference purposes only.