

TO- 277 Plastic-Encapsulate Diodes

Schottky Rectifier Diode

Features

- $I_{F(AV)}$ 5A
- V_{RRM} 100 V
- High surge current capability
- Low peak forward voltage

Applications

- Rectifier

Marking

- SB5100L

Chip

- Planar technology 83MIL

TO-277

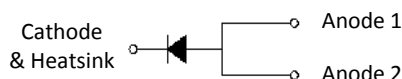
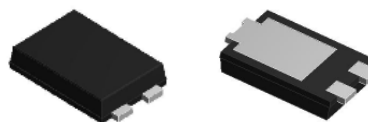

Limiting Values(Absolute Maximum Rating)

Item	Symbol	Unit	Test Conditions	KSB5100L
Repetitive Peak Reverse Voltage	V_{RRM}	V		100
Maximum RMS Voltage	V_{RMS}	V		70
Average Forward Current	$I_{F(AV)}$	A	60Hz Half-sine wave, Resistance load, TL(Fig.1)	5
Surge(Non-repetitive)Forward Current	I_{FSM}	A	60Hz Half-sine wave, 1 cycle, $T_a=25^\circ\text{C}$	120
Junction Temperature	T_J	$^\circ\text{C}$		-55 ~ +150
Storage Temperature	T_{STG}	$^\circ\text{C}$		-55 ~ +150

Electrical Characteristics ($T=25^\circ\text{C}$ Unless otherwise specified)

Item	Symbol	Unit	Test Condition	KSB5100L	
Peak Forward Voltage	V_F	V	$I_F=5.0\text{A}$	$T_a=25^\circ\text{C}$	0.70(TYP) 0.74(MAX)
				$T_a=125^\circ\text{C}$	0.59(TYP) 0.65(MAX)
Peak Reverse Current	I_{RRM1}	μA	$V_{RM}=V_{RRM}$	$T_a=25^\circ\text{C}$	5(TYP) 20(MAX)
	I_{RRM2}	mA		$T_a=125^\circ\text{C}$	15
Thermal Resistance(Typical)	$R_{\theta J-A}$	$^\circ\text{C}/\text{W}$	Between junction and ambient	80	
	$R_{\theta J-L}$		Between junction and terminal	5	
Typical junction capacitance	C_J	pF	$V_R=4.0\text{V}$, $f=1\text{MHz}$	140	

Notes:

Thermal resistance from junction to ambient and from junction to lead mounted on P.C.B. with 0.3" x 0.3" (8.0 mm x 8.0 mm) copper pad areas

Typical Characteristics

FIG.1: FORWARD CURRENT DERATING CURVE

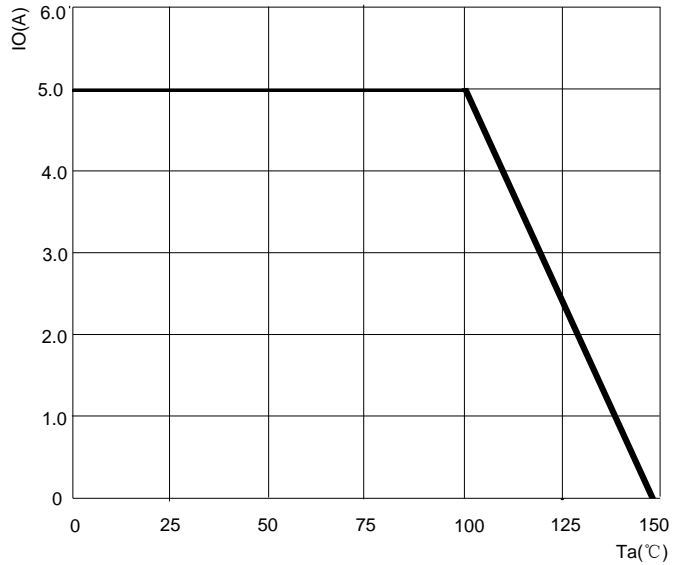

FIG.2: MAXIMUM NON-REPETITIVE FORWARD SURGE CURRENT

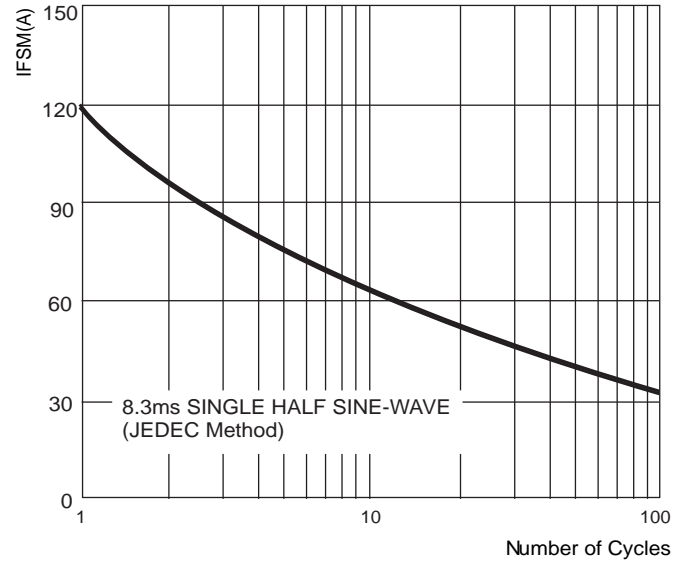

FIG.3: TYPICAL FORWARD CHARACTERISTICS

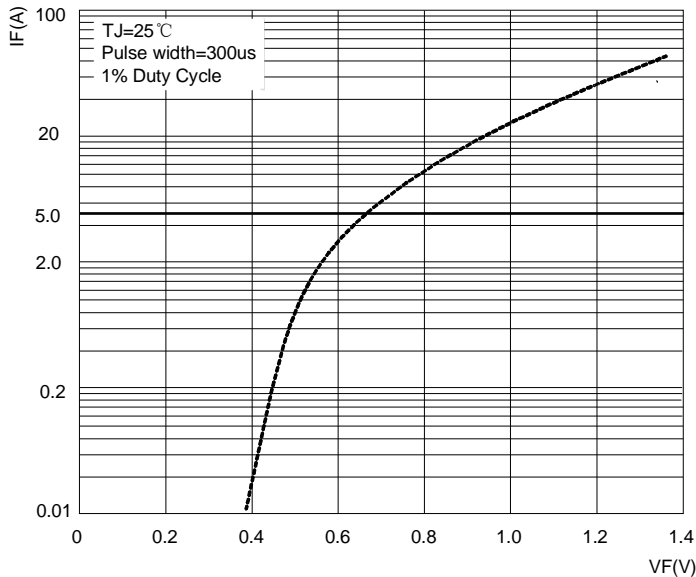
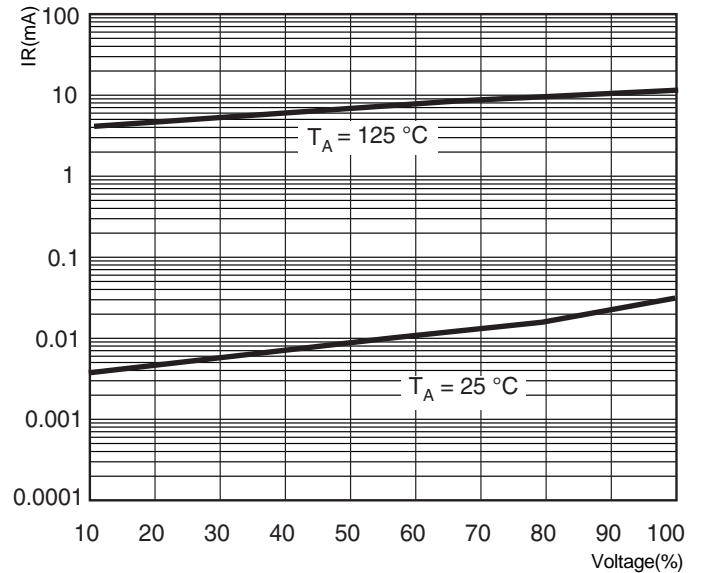
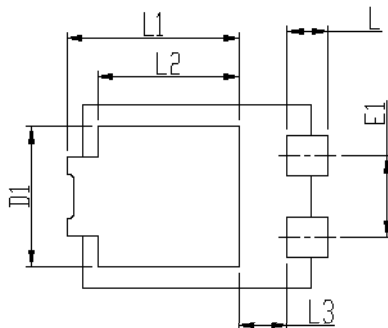
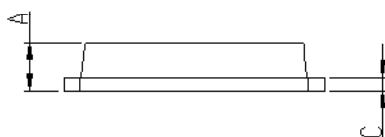
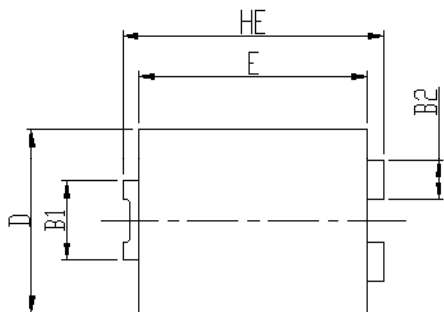

FIG.4: TYPICAL REVERSE CHARACTERISTICS



TO- 277 Package Outline Dimensions



DIM	Unit: mm		Unit: inch	
	MIN	MAX	MIN	MAX
HE	6.4	6.6	0.252	0.260
E	5.6	5.8	0.220	0.228
D	4.1	4.3	0.161	0.169
B1	1.7	1.9	0.067	0.075
B2	0.8	1	0.031	0.039
A	1.05	1.2	0.041	0.047
C	0.3	0.4	0.012	0.016
L	0.85	1.1	0.033	0.043
L1	4.2	4.4	0.165	0.173
L2	3.52 Typ.		0.139 Typ.	
L3	1.1	1.4	0.043	0.055
D1	3	3.3	0.118	0.130
E1	1.86 Typ.		0.073 Typ.	

TO- 277 Suggested Pad Layout

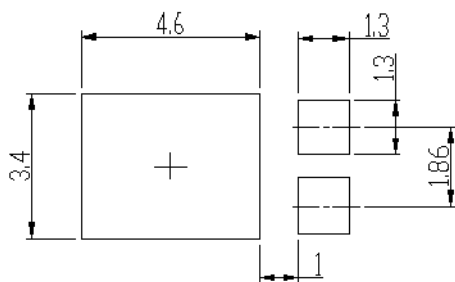

Note:

1. Controlling dimension: in millimeters.
2. General tolerance: ± 0.05 mm.
3. The pad layout is for reference purposes only.