

SOT-323 Plastic-Encapsulate MOSFETS

N-Channel 50-V(D-S) MOSFET

Features:

- High density cell design for extremely low $R_{DS(on)}$
- Rugged and Reliable

Application

- Direct Logic-Level Interface: TTL/CMOS
- Drivers: Relays, Solenoids, Lamps, Hammers; Display, Memories, Transistors, etc.
- Battery Operated Systems
- Solid-State Relays

SOT-323

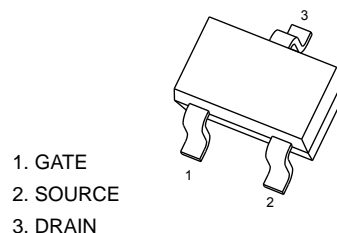

MARKING

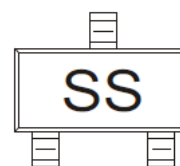

$V_{(BR)DSS}$	$R_{DS(on)MAX}$	I_D
50 V	3.5Ω@10V	220mA
	6Ω@4.5V	

Equivalent Circuit

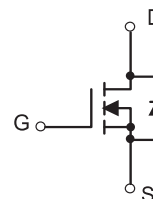

Maximum ratings ($T_a=25^{\circ}C$ unless otherwise noted)

Parameter	Symbol	Value	Unit
Drain-Source Voltage	V_{DS}	50	V
Continuous Gate-Source Voltage	V_{GSS}	±20	
Continuous Drain Current	I_D	0.22	A
Power Dissipation	P_D	0.3	W
Thermal Resistance from Junction to Ambient	$R_{\theta JA}$	417	$^{\circ}C/W$
Operation Junction and Storage Temperature Range	T_J, T_{stg}	-55 ~ +150	$^{\circ}C$

MOSFET ELECTRICAL CHARACTERISTICS

$T_a=25\text{ }^\circ\text{C}$ unless otherwise specified

Parameter	Symbol	Test Condition	Min	Typ	Max	Units
Off characteristics						
Drain-source breakdown voltage	$V_{(BR)DSS}$	$V_{GS} = 0V, I_D = 250\mu A$	50			V
Gate-body leakage	I_{GSS}	$V_{DS} = 0V, V_{GS} = \pm 20V$			± 100	nA
Zero gate voltage drain current	I_{DSS}	$V_{DS} = 50V, V_{GS} = 0V$			0.5	μA
		$V_{DS} = 30V, V_{GS} = 0V$			100	nA
On characteristics						
Gate-threshold voltage (note 1)	$V_{GS(th)}$	$V_{DS} = V_{GS}, I_D = 1mA$	0.80		1.50	V
Static drain-source on-resistance (note 1)	$R_{DS(on)}$	$V_{GS} = 10V, I_D = 0.22A$		0.88	3.50	Ω
		$V_{GS} = 4.5V, I_D = 0.22A$		1.50	6	
Forward transconductance (note 1)	g_{FS}	$V_{DS} = 10V, I_D = 0.22A$	0.12			S
Dynamic characteristics (note 2)						
Input capacitance	C_{iss}	$V_{DS} = 25V, V_{GS} = 0V, f = 1MHz$		27		pF
Output capacitance	C_{oss}			13		
Reverse transfer capacitance	C_{rss}			6		
Switching characteristics						
Turn-on delay time (note 1,2)	$t_{d(on)}$	$V_{DD} = 30V, V_{DS} = 10V, I_D = 0.29A, R_{GEN} = 6\Omega$			5	ns
Rise time (note 1,2)	t_r				18	
Turn-off delay time (note 1,2)	$t_{d(off)}$				36	
Fall time (note 1,2)	t_f				14	
Drain-source body diode characteristics						
Body diode forward voltage (note 1)	V_{SD}	$I_S = 0.44A, V_{GS} = 0V$			1.4	V

Notes:

1. Pulse Test ; Pulse Width $\leq 300\mu s$, Duty Cycle $\leq 2\%$.
2. These parameters have no way to verify.

Typical Characteristics

Output Characteristics

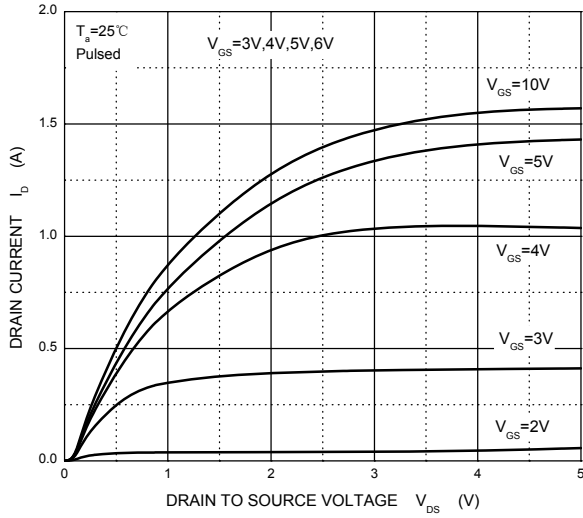

Transfer Characteristics

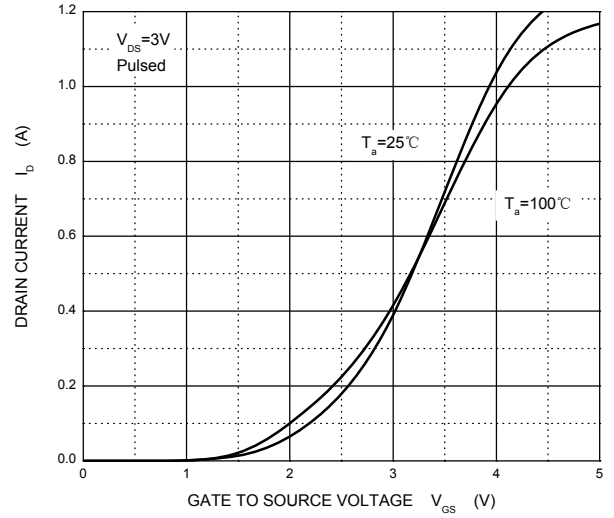

$R_{DS(ON)}$ — I_D

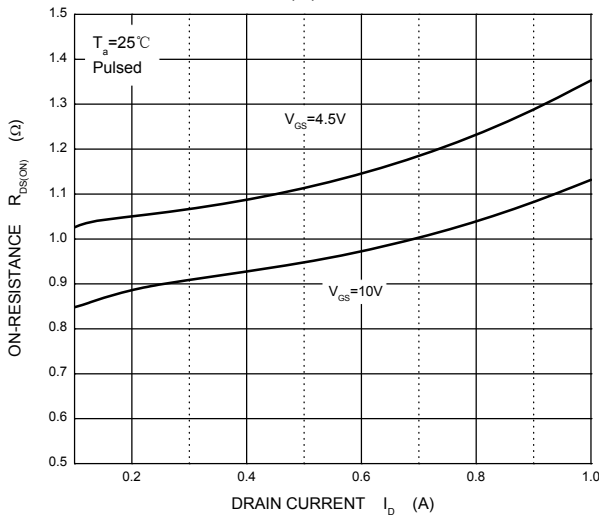

$R_{DS(ON)}$ — V_{GS}

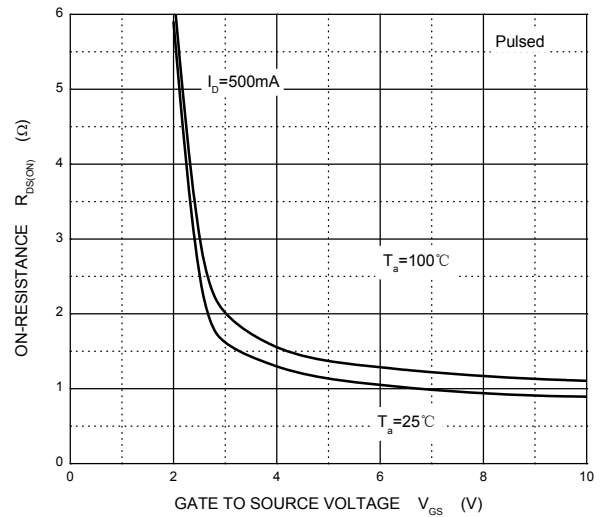

I_S — V_{SD}

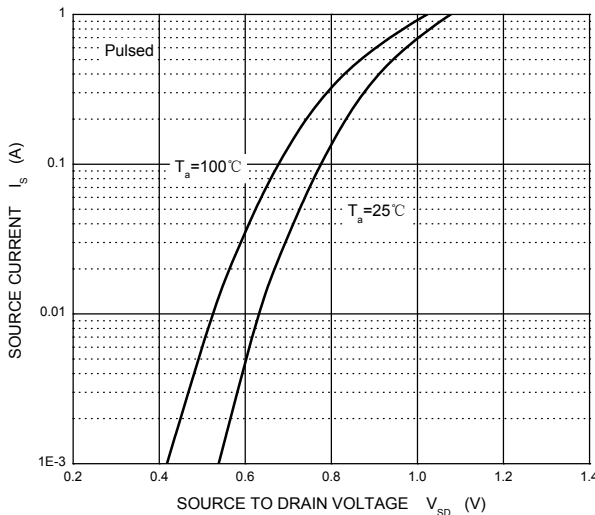

Threshold Voltage

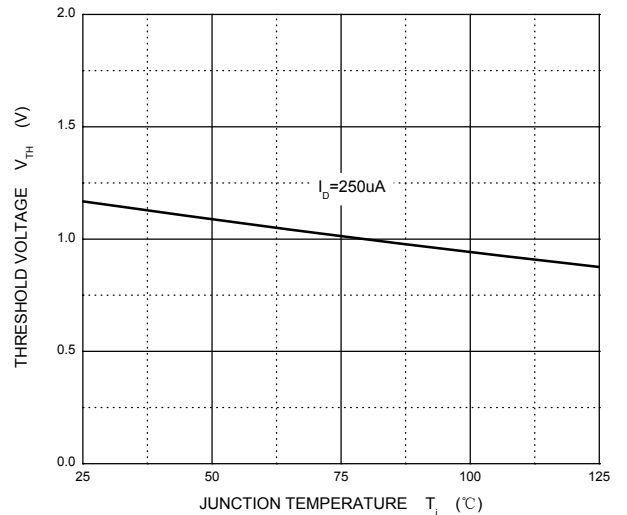

SOT-323 Package Outline Dimensions

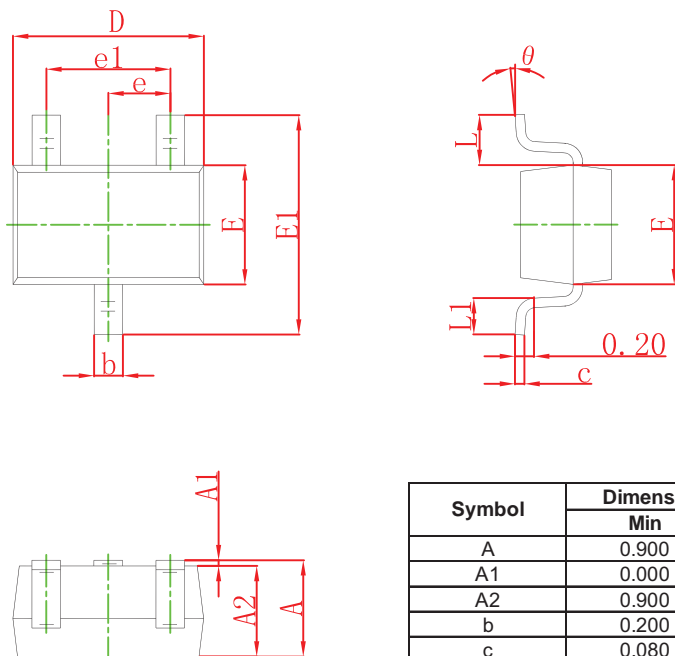

Symbol	Dimensions In Millimeters		Dimensions In Inches	
	Min	Max	Min	Max
A	0.900	1.100	0.035	0.043
A1	0.000	0.100	0.000	0.004
A2	0.900	1.000	0.035	0.039
b	0.200	0.400	0.008	0.016
c	0.080	0.150	0.003	0.006
D	2.000	2.200	0.079	0.087
E	1.150	1.350	0.045	0.053
E1	2.150	2.450	0.085	0.096
e	0.650 TYP		0.026 TYP	
e1	1.200	1.400	0.047	0.055
L	0.525 REF		0.021 REF	
L1	0.260	0.460	0.010	0.018
θ	0°	8°	0°	8°

SOT-323 Suggested Pad Layout

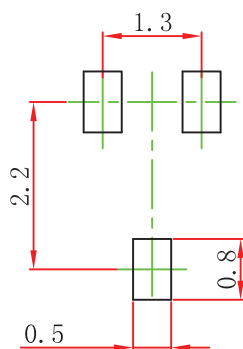

Note:
 1. Controlling dimension: in millimeters.
 2. General tolerance: ±0.05mm.
 3. The pad layout is for reference purposes only.

SOT-323 Tape and Reel

SOT-323 Embossed Carrier Tape

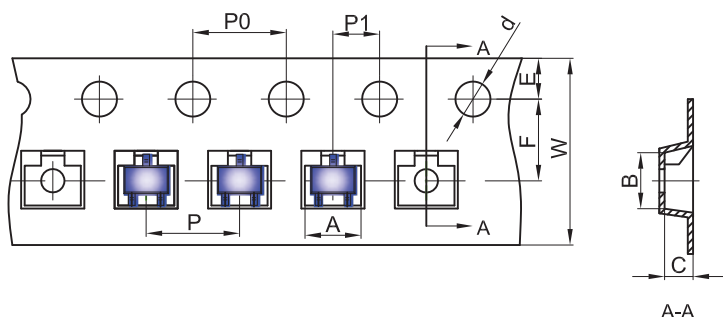

Packaging Description:
 SOT-323 parts are shipped in tape. The carrier tape is made from a dissipative (carbon filled) polycarbonate resin. The cover tape is a multilayer film (Heat Activated Adhesive in nature) primarily composed of polyester film, adhesive layer, sealant, and anti-static sprayed agent. These reeled parts in standard option are shipped with 3,000 units per 7" or 17.8cm diameter reel. The reels are clear in color and is made of polystyrene plastic (anti-static coated).

Dimensions are in millimeter										
Pkg type	A	B	C	d	E	F	P0	P	P1	W
SOT-323	2.25	2.55	1.19	Ø1.55	1.75	3.50	4.00	4.00	2.00	8.00

SOT-323 Tape Leader and Trailer

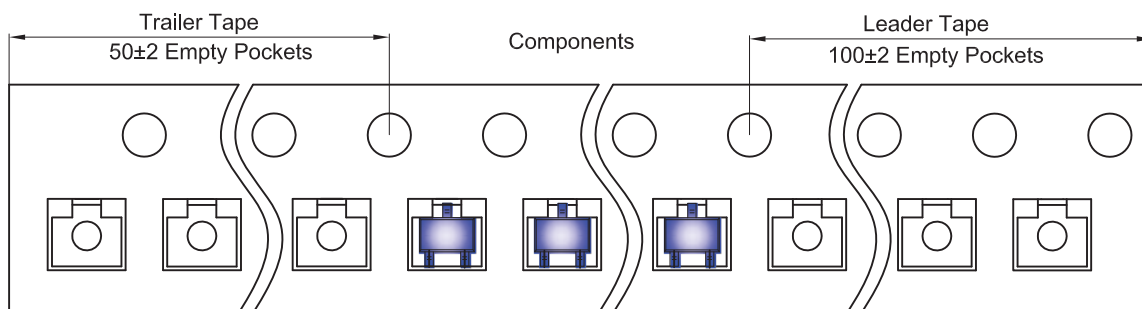

SOT-323 Reel

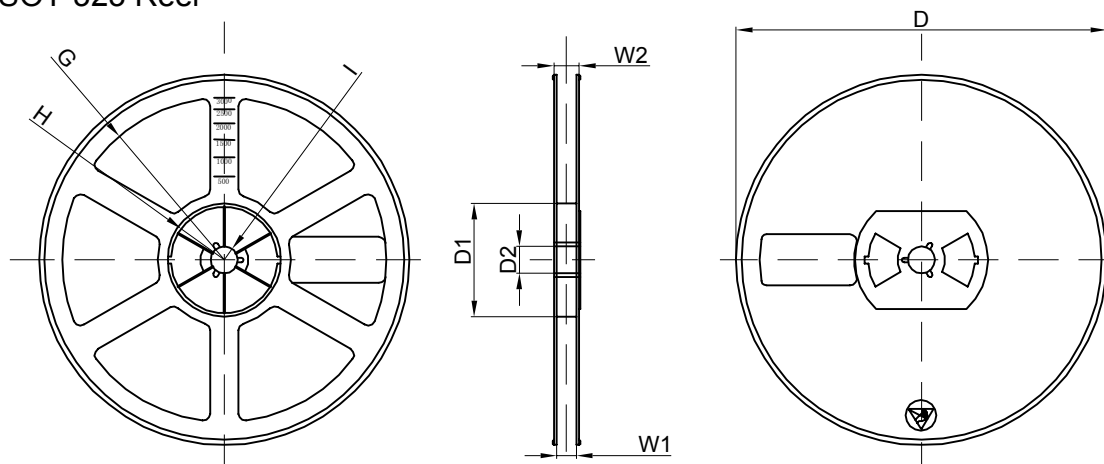

Dimensions are in millimeter								
Reel Option	D	D1	D2	G	H	I	W1	W2
7" Dia	Ø178.00	54.40	13.00	R78.00	R25.60	R6.50	9.50	12.30

REEL	Reel Size	Box	Box Size(mm)	Carton	Carton Size(mm)	G.W.(kg)
3000 pcs	7 inch	45,000 pcs	203×203×195	180,000 pcs	438×438×220	