

SOD-323 Plastic-Encapsulate Diodes

Features:

- Extremely Fast Switching Speed
- Low Forward Voltage

MARKING:

BAT54WS: B3 L9

SOD-323

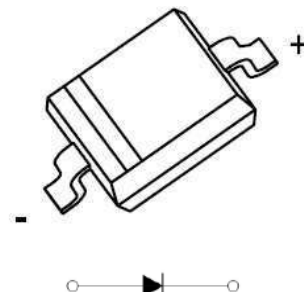

Maximum Ratings @Ta=25°C

Parameter	Symbol	Limit	Unit
Non-Repetitive Peak Reverse Voltage	V_{RM}	30	V
DC Blocking Voltage	V_R	21	V
Average Rectified Output Current	I_O	100	mA
Forward Continuous Current	I_F	200	mA
Repetitive Peak Forward Current	I_{FRM}	300	mA
Non-repetitive Peak Forward Surge Current @t=8.3ms	I_{FSM}	600	mA
Power Dissipation	P_D	200	mW
Thermal Resistance Junction to Ambient	$R_{\theta JA}$	500	°C/W
Junction Temperature	T_J	125	°C
Storage Temperature Range	T_{STG}	-55~+150	°C

Electrical Characteristics @Ta=25°C

Parameter	Symbol	Conditions	Min	Typ	Max	Unit
Reverse breakdown voltage	$V_{(BR)}$	$I_R=100\mu A$	30			V
Forward voltage	V_{F1}	$I_F=0.1mA$			240	mV
	V_{F2}	$I_F=1.0mA$			320	mV
	V_{F3}	$I_F=10mA$			400	mV
	V_{F4}	$I_F=30mA$			500	mV
	V_{F5}	$I_F=100mA$			1000	mV
Reverse current	I_R	$V_R=25V$			2.0	uA
Reverse recovery time	t_{rr}	$I_F=10mA, I_R=10mA$ to 1mA, $R_L=100\Omega$			5.0	ns
Capacitance between terminals	C_T	$V_R=1V, f=1MHz$			10	pF

Typical Characteristics

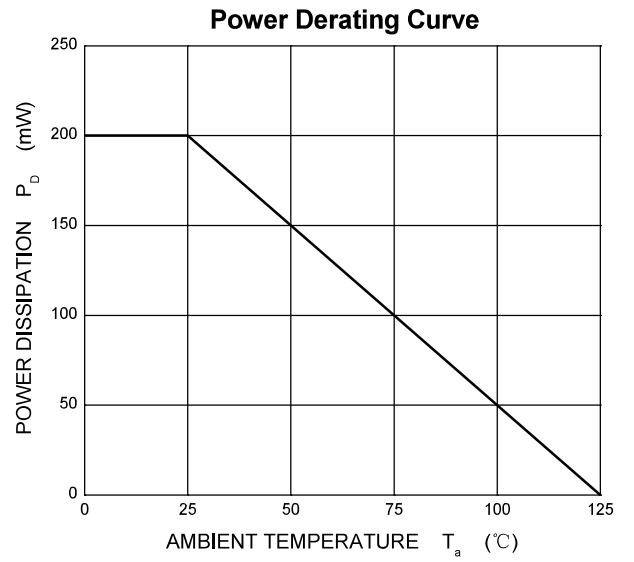
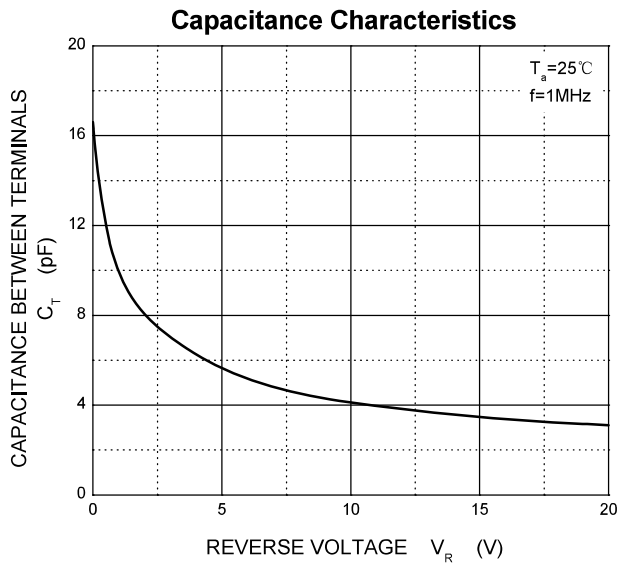
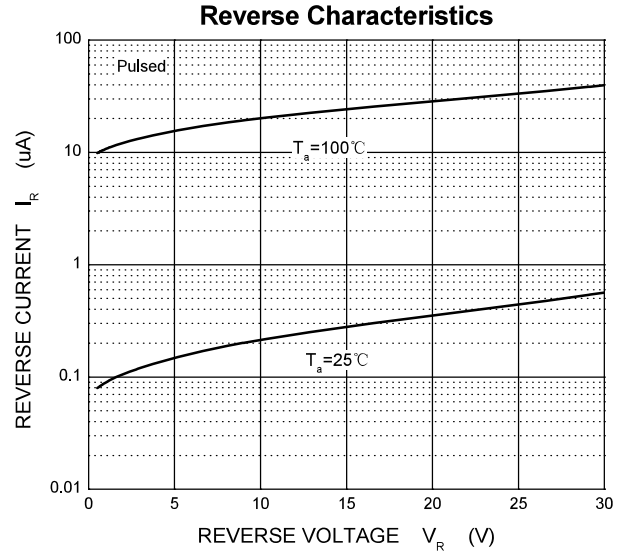
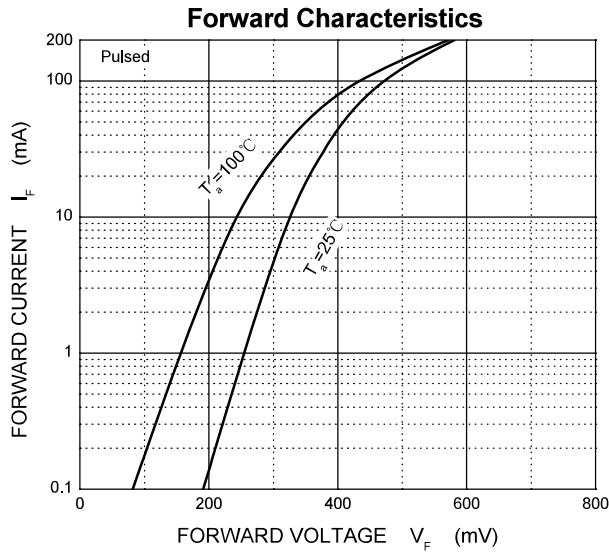

SOD-323 Package Outline Dimensions

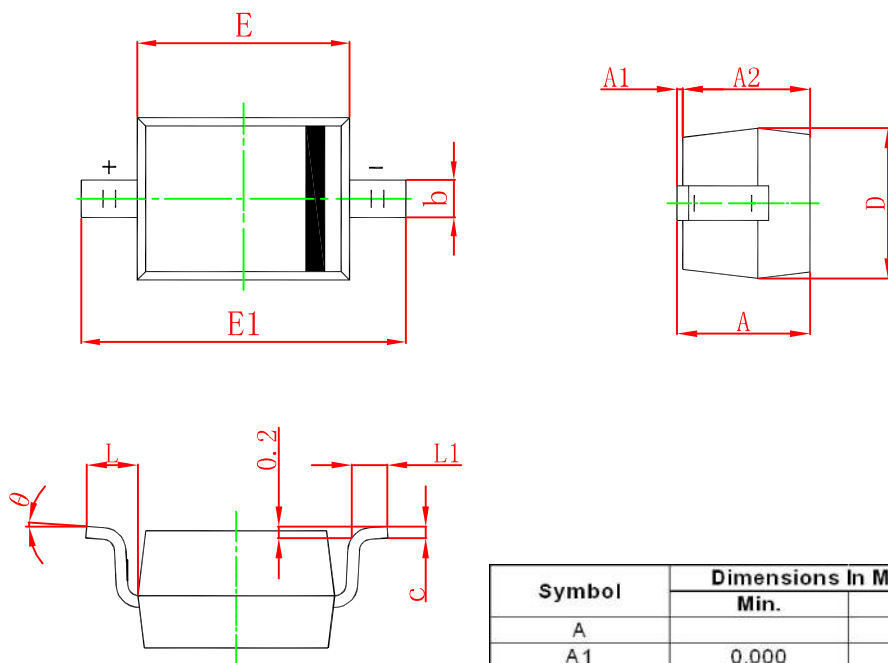

Symbol	Dimensions In Millimeters		Dimensions In Inches	
	Min.	Max.	Min.	Max.
A		1.000		0.039
A1	0.000	0.100	0.000	0.004
A2	0.800	0.900	0.031	0.035
b	0.250	0.350	0.010	0.014
c	0.080	0.150	0.003	0.006
D	1.200	1.400	0.047	0.055
E	1.600	1.800	0.063	0.071
E1	2.550	2.750	0.100	0.108
L	0.475 REF.		0.019 REF.	
L1	0.250	0.400	0.010	0.016
θ	0°	8°	0°	8°

SOD-323 Suggested Pad Layout

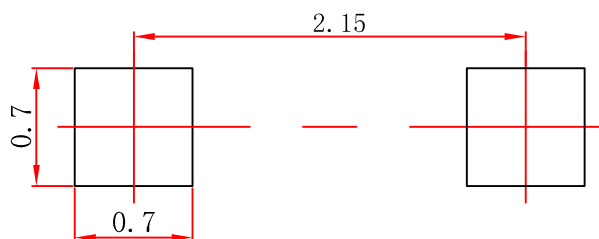

- Note:**
1. Controlling dimension: in millimeters.
 2. General tolerance: ± 0.05 mm.
 3. The pad layout is for reference purposes only.

SOD-323 Tape and Reel

SOD-323 Embossed Carrier Tape

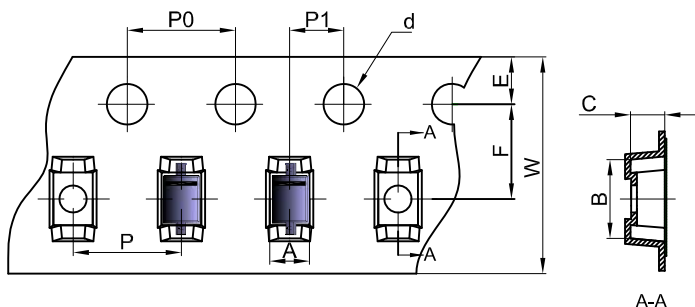

Packaging Description:
 SOD-323 parts are shipped in tape. The carrier tape is made from a dissipative (carbon filled) polycarbonate resin. The cover tape is a multilayer film (Heat Activated Adhesive in nature) primarily composed of polyester film, adhesive layer, sealant, and anti-static sprayed agent. These reeled parts in standard option are shipped with 3,000 units per 7" or 17.8cm diameter reel. The reels are clear in color and is made of polystyrene plastic (anti-static coated).

Dimensions are in millimeter										
Pkg type	A	B	C	d	E	F	P0	P	P1	W
SOD-323	1,48	3,3	1,25	Ø1,50	1,75	3,50	4,00	4,00	2,00	8,00

SOD-323 Tape Leader and Trailer

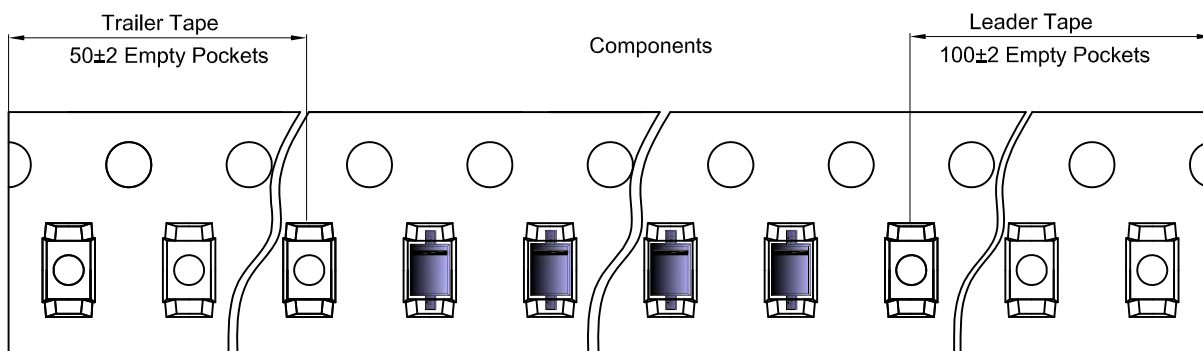

SOD-323 Reel

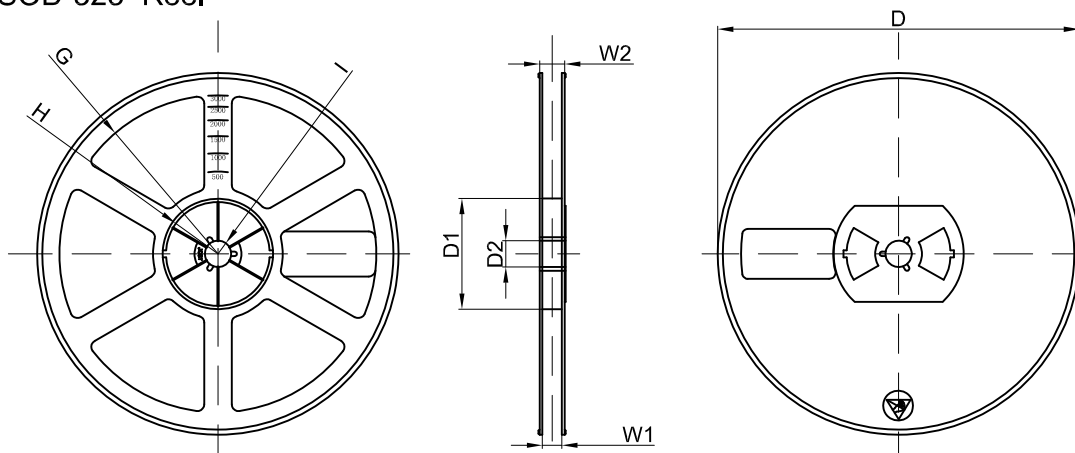

Dimensions are in millimeter								
Reel Option	D	D1	D2	G	H	I	W1	W2
7"Dia	Ø178,00	54,40	13,00	R78,00	R25,60	R6,50	9,50	12,30

REEL	Reel Size	Box	Box Size(mm)	Carton	Carton Size(mm)	G.W.(kg)
3000 pcs	7 inch	45,000 pcs	203×203×195	180,000 pcs	438×438×220	