

SOT-23 Plastic-Encapsulate Diodes

SWITCHING DIODE

Features:

- This Switching Diode has The Following Features:
- Low Leakage Current Applications

Marking: JY / A7 / PX

SOT-23

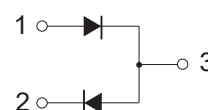
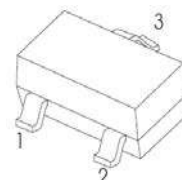

Maximum Ratings @Ta=25°C

Parameter	Symbol	Limit	Unit
Non-Repetitive Peak Reverse Voltage	V_{RM}	70	V
DC Blocking Voltage	V_R	70	V
Forward Continuous Current	I_{FM}	500	mA
Average Rectified Output Current	I_O	215	mA
Non-Repetitive Peak Forward Surge Current @t=8.3ms	I_{FSM}	1.0	A
Power Dissipation	P_D	200	mW
Operation Junction and Storage Temperature Range	T_J, T_{STG}	-55~+150	°C

ELECTRICAL CHARACTERISTICS (Ta=25°C unless otherwise specified)

Parameter	Symbol	Test conditions	Min	Max	Unit
Reverse breakdown voltage	$V_{(BR)}$	$I_R = 100\mu A$	70		V
Reverse voltage leakage current	I_R	$V_R = 70V$		5	nA
Forward voltage	V_F	$I_F = 1mA$ $I_F = 10mA$ $I_F = 50mA$ $I_F = 150mA$		900 1000 1100 1250	mV
Diode capacitance	C_D	$V_R = 0, f = 1MHz$		2	pF
Reverse recovery time	t_{rr}	$I_F = I_R = 10mA$		3	μs

Typical Characteristics

Forward Characteristics

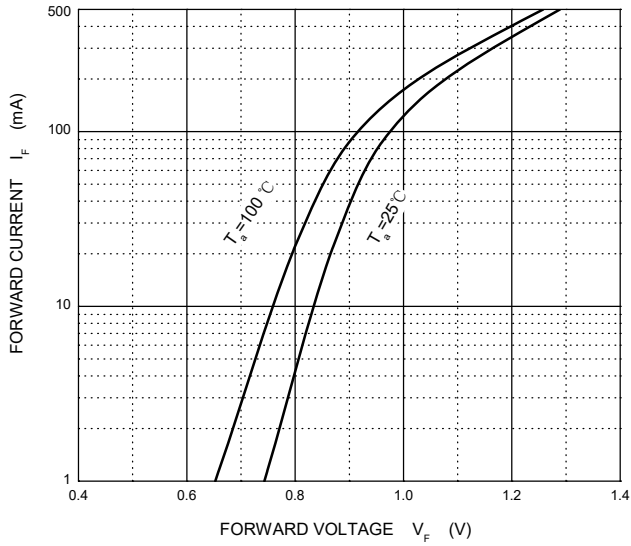

Reverse Characteristics

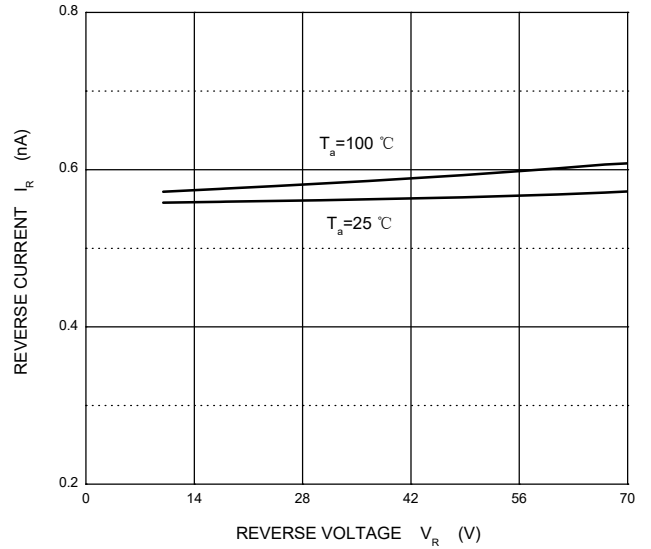

Capacitance Characteristics

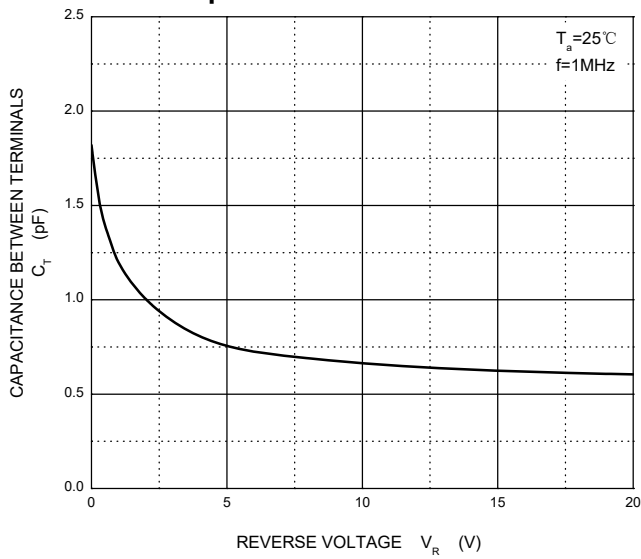

Power Derating Curve

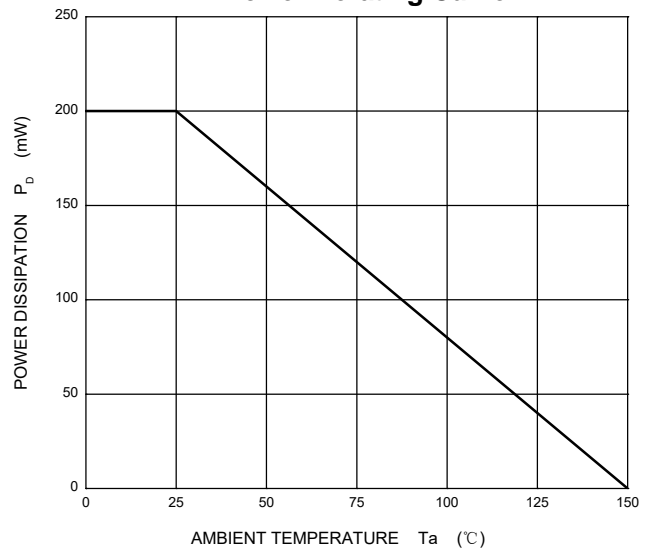

SOT-23 Package Outline Dimensions

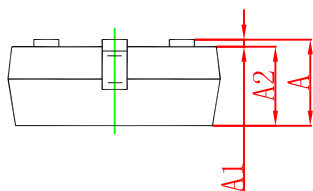
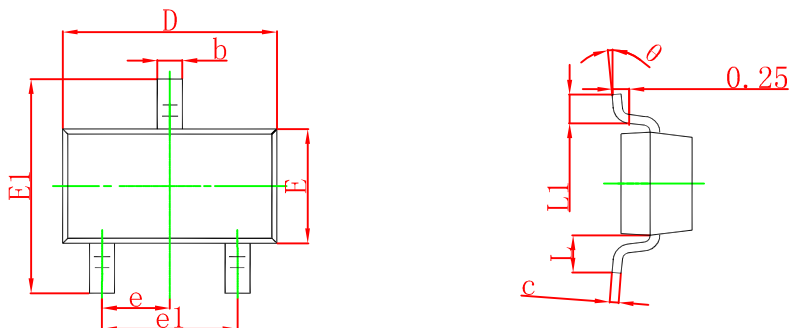

Symbol	Dimensions In Millimeters		Dimensions In Inches	
	Min	Max	Min	Max
A	0.900	1.150	0.035	0.045
A1	0.000	0.100	0.000	0.004
A2	0.900	1.050	0.035	0.041
b	0.300	0.500	0.012	0.020
c	0.080	0.150	0.003	0.006
D	2.800	3.000	0.110	0.118
E	1.200	1.400	0.047	0.055
E1	2.250	2.550	0.089	0.100
e	0.950 TYP		0.037 TYP	
e1	1.800	2.000	0.071	0.079
L	0.550 REF		0.022 REF	
L1	0.300	0.500	0.012	0.020
θ	0°	8°	0°	8°

SOT-23 Suggested Pad Layout

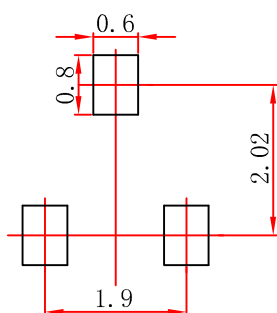

- Note:
1. Controlling dimension: in millimeters.
 2. General tolerance: ± 0.05 mm.
 3. The pad layout is for reference purposes only.

SOT-23 Tape and Reel

SOT-23 Embossed Carrier Tape

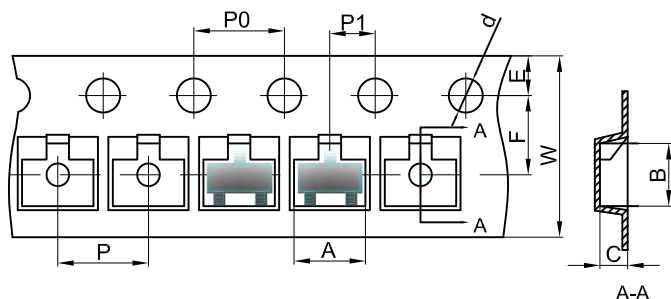

Dimensions are in millimeter										
Pkg type	A	B	C	d	E	F	P0	P	P1	W
SOT-23	3.15	2.77	1.22	Ø1.50	1.75	3.50	4.00	4.00	2.00	8.00

SOT-23 Tape Leader and Trailer

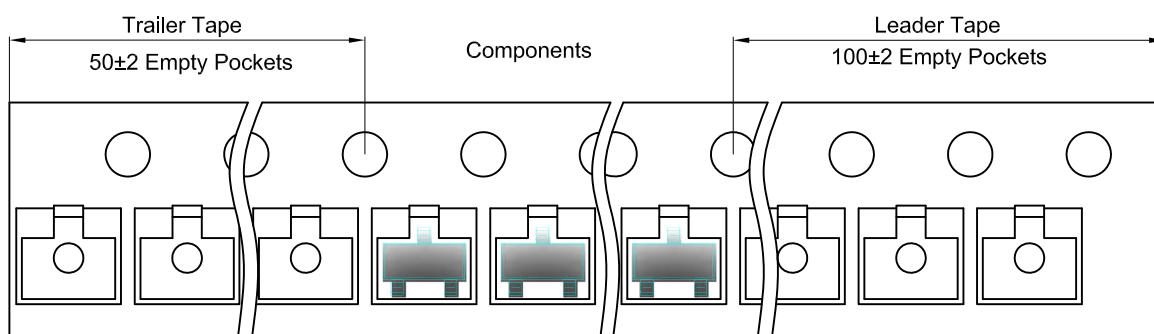

SOT-23 Reel

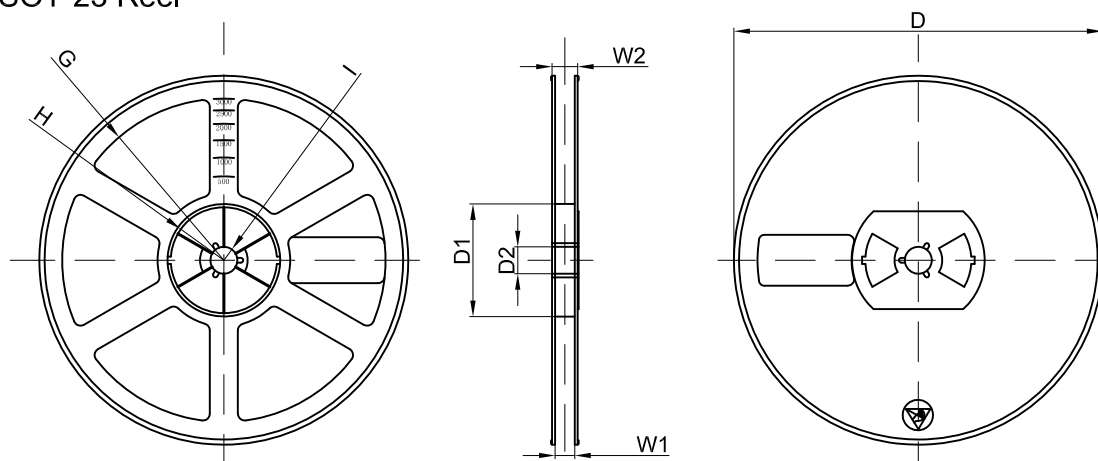

Dimensions are in millimeter								
Reel Option	D	D1	D2	G	H	I	W1	W2
7" Dia	Ø178.00	54.40	13.00	R78.00	R25.60	R6.50	9.50	12.30

REEL	Reel Size	Box	Box Size(mm)	Carton	Carton Size(mm)	G.W.(kg)
3000 pcs	7 inch	45,000 pcs	203×203×195	180,000 pcs	438×438×220	