

SCHOKKTY BARRIER DIODE

Features:

SOT-323

- Low turn-on voltage
- Fast switching
- Also available in lead free version

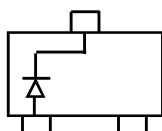
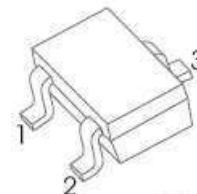

BAS70W Marking: K73

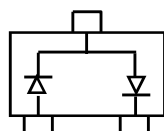

BAS70W-04 Marking: K74

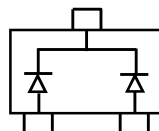



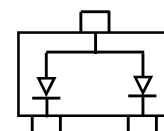

BAS70W-05 Marking: K75



BAS70W-06 Marking: K76

MARKING:

BAS70W	BAS70W-04	BAS70W-05	BAS70W-06
			

Solid dot = Green molding compound device, if none, the normal device.

MAXIMUM RATINGS @T_a=25°C

Symbol	Parameter	Value	Unit
V _R	DC Voltage	70	V
I _F	Forward Continuous Current	70	mA
I _{FSM}	Non-Repetitive Peak Forward Surge Current @ t = 8.3ms	100	mA
P _D	Power Dissipation	200	mW
R _{θJA}	Thermal Resistance from Junction to Ambient	500	°C/W
T _J	Operating Junction Temperature Range	-40 ~ +125	°C
T _{stg}	Storage Temperature Range	-55 ~ +150	°C

ELECTRICAL CHARACTERISTICS (T_a=25°C unless otherwise specified)

Parameter	Symbol	Test conditions	Min	Max	Unit
Reverse breakdown voltage	V _(BR)	I _R = 10μA	70		V
Reverse voltage leakage current	I _R	V _R =50V		100	nA
Forward voltage	V _F	I _F =1mA I _F =15mA		410 1000	mV
Diode capacitance	C _D	V _R =0V, f=1MHz		2	pF
Revers recovery time	t _{rr}	I _F =I _R =10mA, I _{rr} =0.1xI _R , R _L =100Ω		5	ns

Typical Characteristics

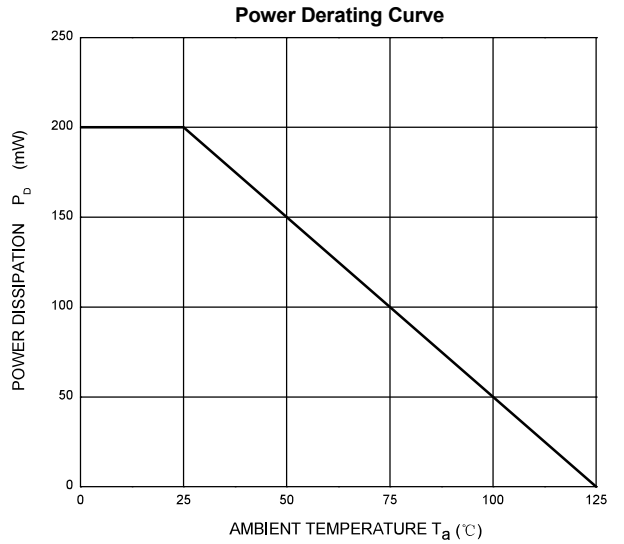
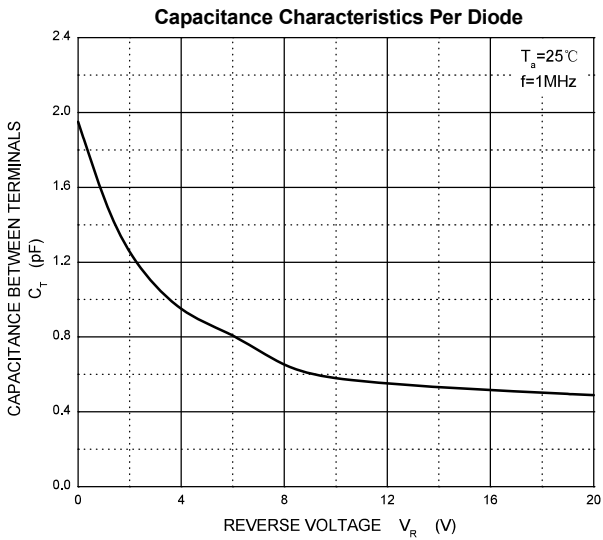
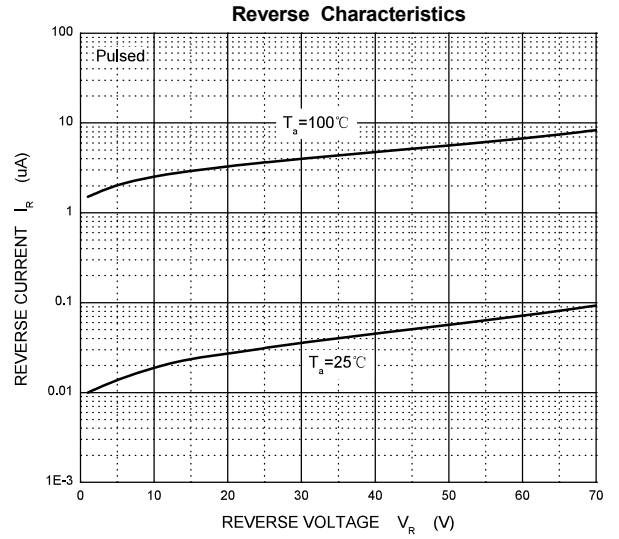
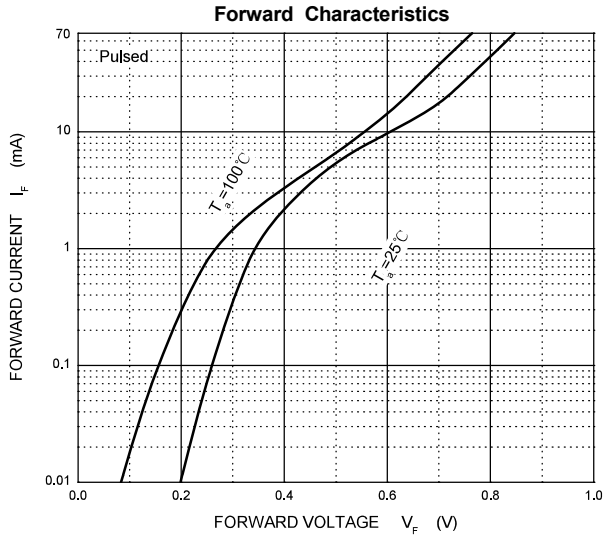

SOT-323 Package Outline Dimensions

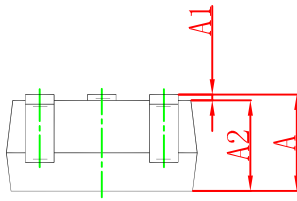
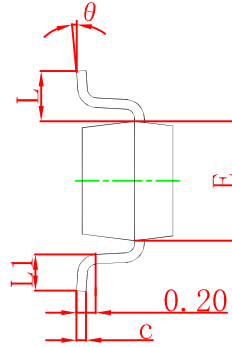
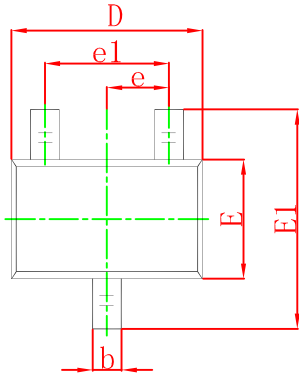

Symbol	Dimensions In Millimeters		Dimensions In Inches	
	Min	Max	Min	Max
A	0.900	1.100	0.035	0.043
A1	0.000	0.100	0.000	0.004
A2	0.900	1.000	0.035	0.039
b	0.200	0.400	0.008	0.016
c	0.080	0.150	0.003	0.006
D	2.000	2.200	0.079	0.087
E	1.150	1.350	0.045	0.053
E1	2.150	2.450	0.085	0.096
e	0.650 TYP		0.026 TYP	
e1	1.200	1.400	0.047	0.055
L	0.525 REF		0.021 REF	
L1	0.260	0.460	0.010	0.018
θ	0°	8°	0°	8°

SOT-323 Suggested Pad Layout

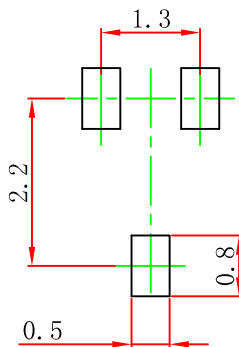

- Note:
1. Controlling dimension: in millimeters.
 2. General tolerance: ± 0.05 mm.
 3. The pad layout is for reference purposes only.

SOT-323 Tape and Reel

SOT-323 Embossed Carrier Tape

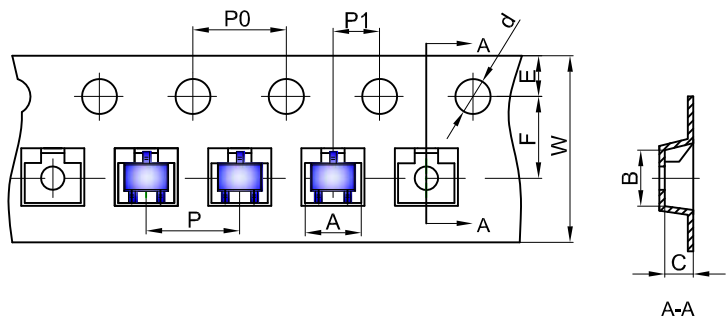

Packaging Description:

SOT-323 parts are shipped in tape. The carrier tape is made from a dissipative (carbon filled) polycarbonate resin. The cover tape is a multilayer film (Heat Activated Adhesive in nature) primarily composed of polyester film, adhesive layer, sealant, and anti-static sprayed agent. These reeled parts in standard option are shipped with 3,000 units per 7" or 17.8cm diameter reel. The reels are clear in color and is made of polystyrene plastic (anti-static coated).

Dimensions are in millimeter										
Pkg type	A	B	C	d	E	F	P0	P	P1	W
SOT-323	2,25	2,55	1,19	Ø1,55	1,75	3,50	4,00	4,00	2,00	8,00

SOT-323 Tape Leader and Trailer

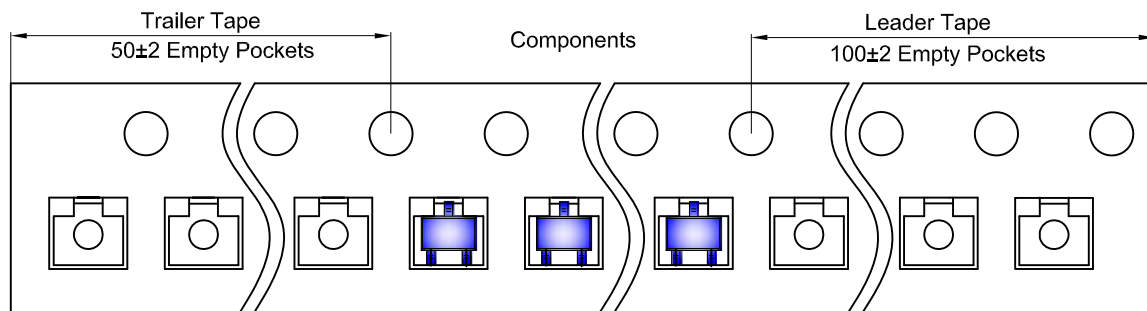

SOT-323 Reel

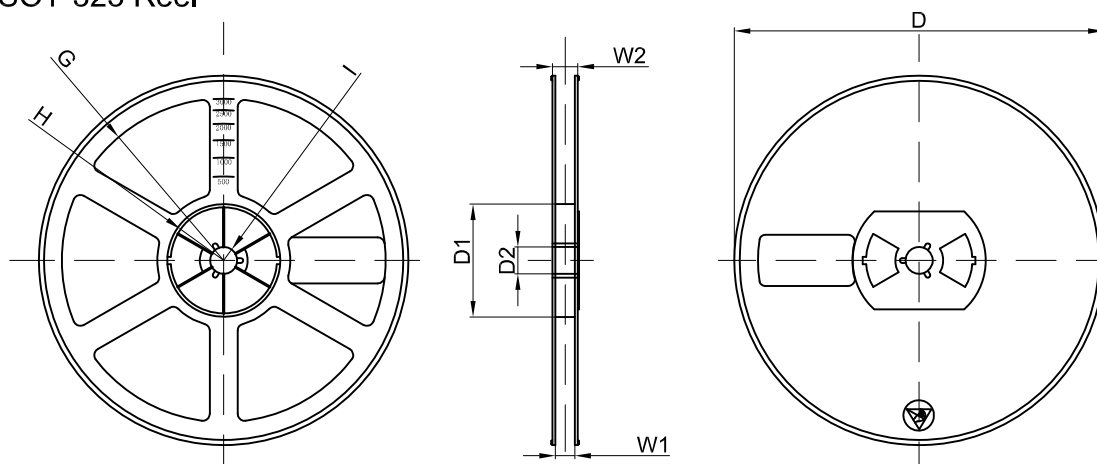

Dimensions are in millimeter								
Reel Option	D	D1	D2	G	H	I	W1	W2
7" Dia	Ø178.00	54.40	13.00	R78.00	R25.60	R6.50	9.50	12.30

REEL	Reel Size	Box	Box Size(mm)	Carton	Carton Size(mm)	G.W.(kg)
3000 pcs	7 inch	45,000 pcs	203×203×195	180,000 pcs	438×438×220	