

## SOD-323 Plastic-Encapsulate Diodes

SWITCHING DIODE

### Features:

- Fast Switching Speed
- Surface Mount Package Ideally Suited for Automatic Insertion
- For General Purpose Switching Applications
- High Conductance

### MARKING:



SOD-323

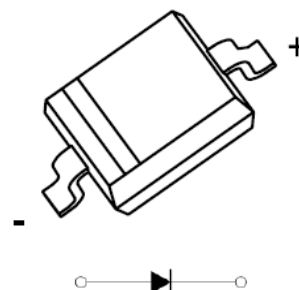

### Maximum Ratings @Ta=25°C

Parameter	Symbol	Value	Unit
Peak Repetitive Reverse Voltage	$V_{RRM}$	250	V
DC Blocking Voltage	$V_R$		
Average Rectified Output Current	$I_O$	200	mA
Non-Repetitive Peak Forward Surge Current @t=8.3ms	$I_{FSM}$	625	mA
Power Dissipation	$P_D$	200	mW
Thermal Resistance from Junction to Ambient	$R_{\theta JA}$	625	°C/W
Operation Junction and Storage Temperature Range	$T_J, T_{stg}$	-55~+150	°C

### ELECTRICAL CHARACTERISTICS (Ta=25°C unless otherwise specified)

Parameter	Symbol	Test conditions	Min	Max	Unit
Reverse breakdown voltage	$V_{(BR)}$	$I_R = 100\mu A$	250		V
Reverse voltage leakage current	$I_R$	$V_R = 200V$		0.1	$\mu A$
Forward voltage	$V_F$	$I_F = 100mA$ $I_F = 200mA$		1 1.25	V
Diode capacitance	$C_D$	$V_R = 0V, f = 1MHz$		5	pF
Reverses recovery time	$t_{rr}$	$I_F = I_R = 30mA, R_L = 100\Omega$		50	ns

**Typical Characteristics**

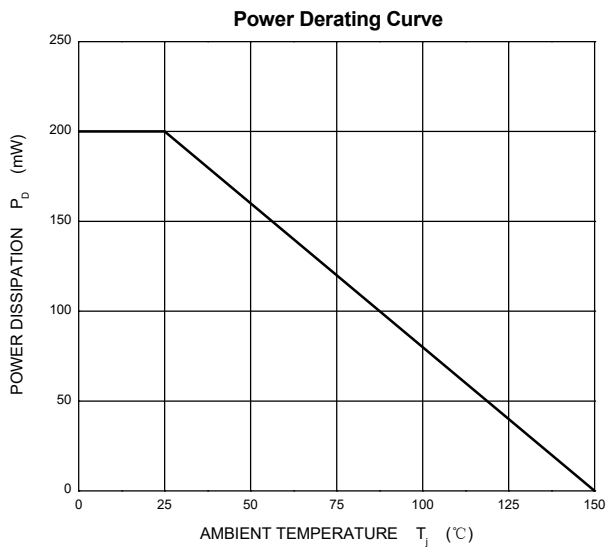
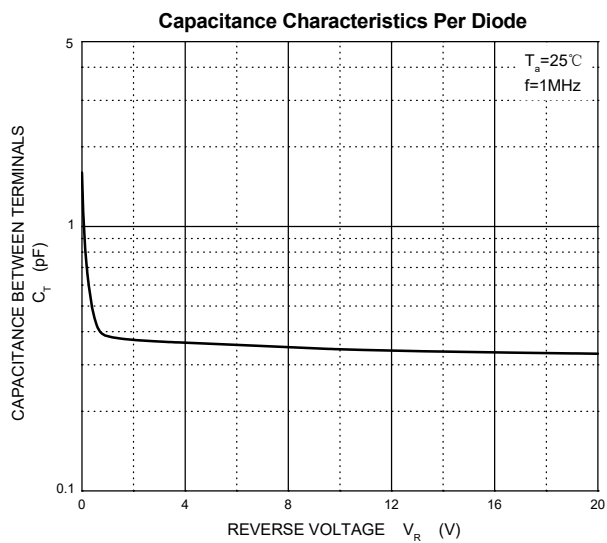
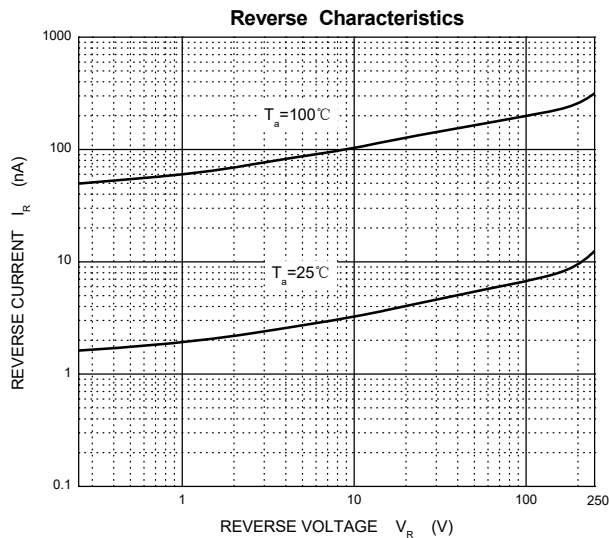
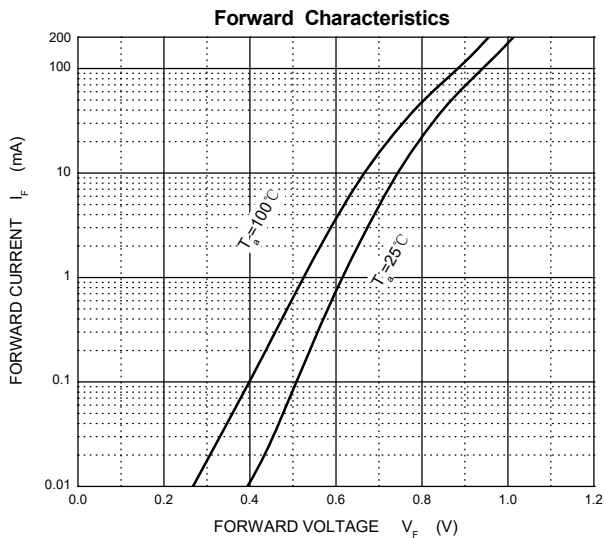

PACKAGE OUTLINE AND PAD LAYOUT INFORMATION

SOD-323 Package Outline Dimensions

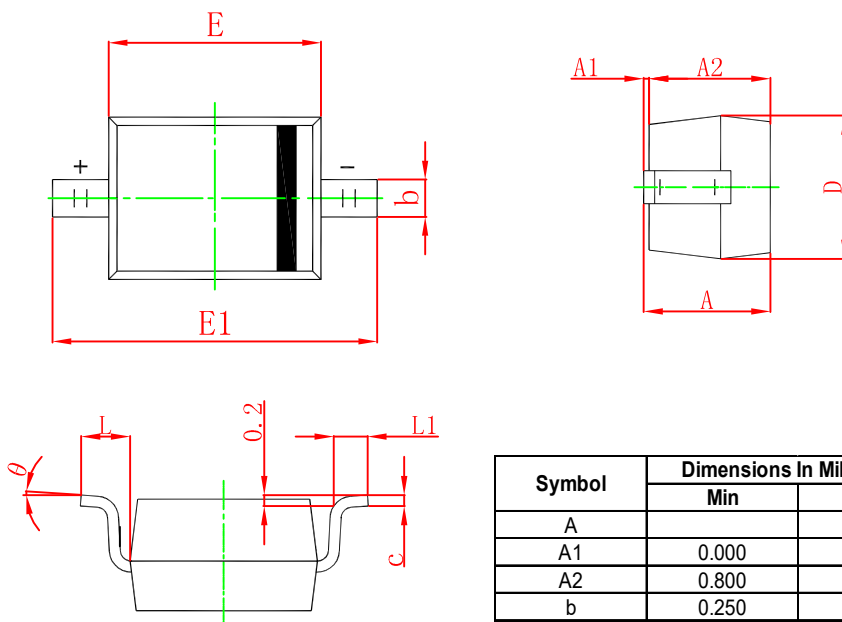

Symbol	Dimensions In Millimeters		Dimensions In Inches	
	Min	Max	Min	Max
A		1.100		0.043
A1	0.000	0.100	0.000	0.004
A2	0.800	1.000	0.031	0.039
b	0.250	0.350	0.010	0.014
c	0.080	0.150	0.003	0.006
D	1.200	1.400	0.047	0.055
E	1.600	1.800	0.063	0.071
E1	2.500	2.750	0.098	0.108
L	0.475 REF		0.019 REF	
L1	0.250	0.400	0.010	0.016
θ	0°	8°	0°	8°

SOD-323 Suggested Pad Layout

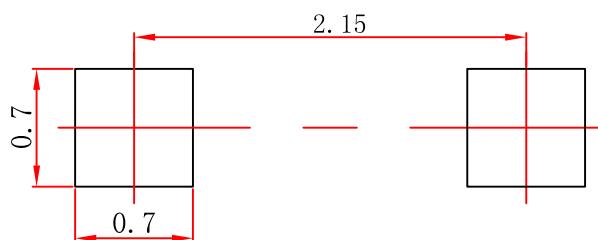

**Note:**

1. Controlling dimension: in millimeters.
2. General tolerance:  $\pm 0.05\text{mm}$ .
3. The pad layout is for reference purposes only.

### SOD-323 Tape and Reel

#### SOD-323 Embossed Carrier Tape

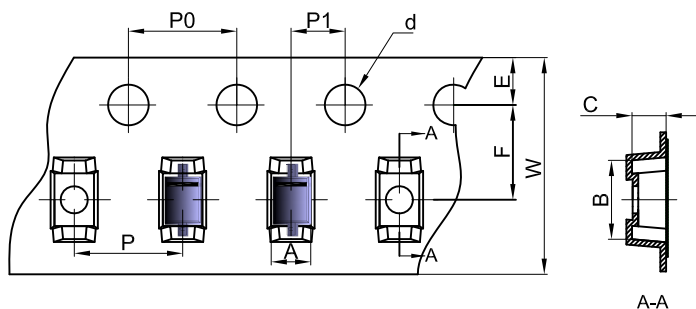

Dimensions are in millimeter										
Pkg type	A	B	C	d	E	F	P0	P	P1	W
SOD-323	1.48	3.3	1.25	Ø1.50	1.75	3.50	4.00	4.00	2.00	8.00

#### SOD-323 Tape Leader and Trailer

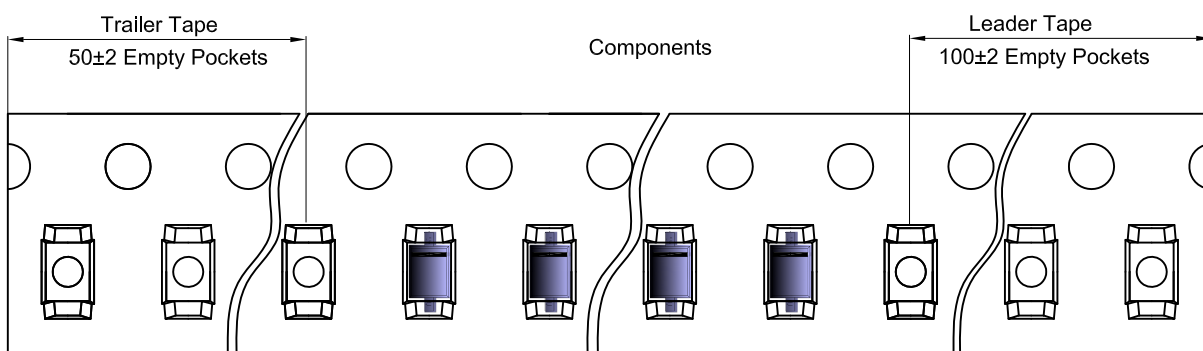

#### SOD-323 Reel

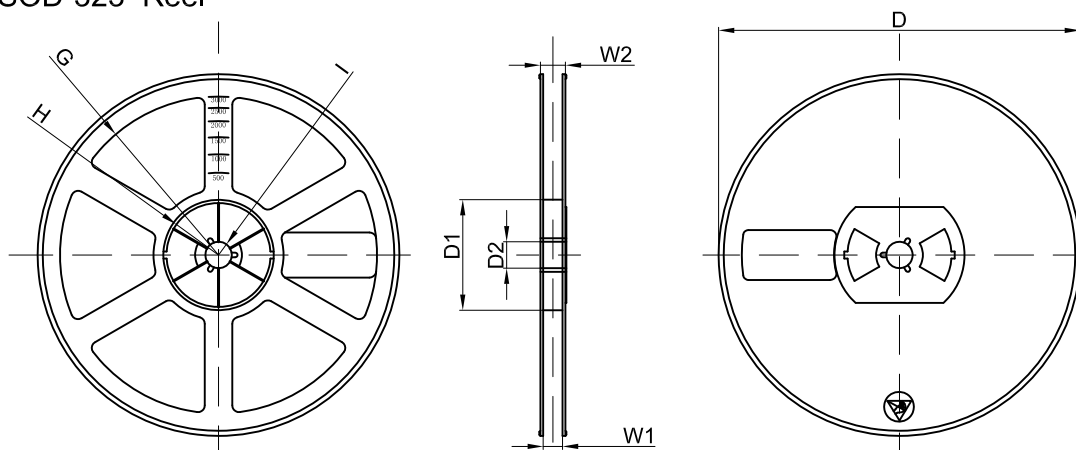

Dimensions are in millimeter								
Reel Option	D	D1	D2	G	H	I	W1	W2
7" Dia	Ø178.00	54.40	13.00	R78.00	R25.60	R6.50	9.50	12.30

REEL	Reel Size	Box	Box Size(mm)	Carton	Carton Size(mm)	G.W.(kg)
3000 pcs	7 inch	45,000 pcs	203×203×195	180,000 pcs	438×438×220	