

## SOT-363 Plastic-Encapsulate Transistors

DUAL TRANSISTOR (PNP+PNP)

### Features:

- Two transistors in one package
- Reduces number of components and board space
- No mutual interference between the transistors

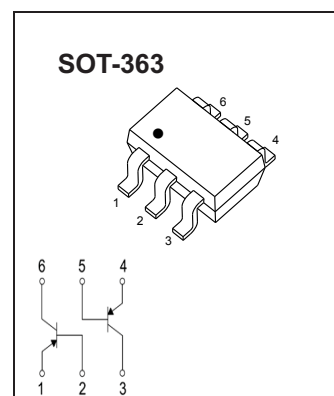
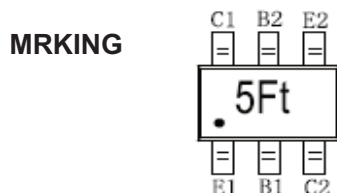

MAXIMUM RATINGS ( $T_a=25^{\circ}\text{C}$  unless otherwise noted)

Symbol	Parameter	Value	Units
$V_{CB0}$	Collector- Base Voltage	-80	V
$V_{CEO}$	Collector-Emitter Voltage	-65	V
$V_{EBO}$	Emitter-Base Voltage	-5	V
$I_C$	Collector Current -Continuous	-0.1	A
$P_C$	Collector Power Dissipation	0.2	W
$R_{\theta JA}$	Thermal Resistance from Junction to Ambient	625	$^{\circ}\text{C}/\text{W}$
$T_J, T_{STG}$	Operation Junction and Storage Temperature Range	-55~+150	$^{\circ}\text{C}$

ELECTRICAL CHARACTERISTICS PNP 5401 ( $T_a=25^{\circ}\text{C}$  unless otherwise specified)

Parameter	Symbol	Test conditions	Min	Typ	Max	Unit
Collector-base breakdown voltage	$V_{(BR)CB0}$	$I_C=-10\mu\text{A}, I_E=0$	-80			V
Collector-emitter breakdown voltage	$V_{(BR)CEO}$	$I_C=-10\text{mA}, I_B=0$	-65			V
Emitter-base breakdown voltage	$V_{(BR)EBO}$	$I_E=-10\mu\text{A}, I_C=0$	-5			V
Collector cut-off current	$I_{CBO}$	$V_{CB}=-30\text{V}, I_E=0$			-15	nA
Emitter cut-off current	$I_{EBO}$	$V_{EB}=-5\text{V}, I_C=0$			-100	nA
DC current gain	$h_{FE}$	$V_{CE}=-5\text{V}, I_C=-2\text{mA}$	110			
Collector-emitter saturation voltage	$V_{CE(sat)}$	$I_C=-10\text{mA}, I_B=-0.5\text{mA}$			-0.1	V
		$I_C=-100\text{mA}, I_B=-5\text{mA}^*$			-0.3	V
Base-emitter saturation voltage	$V_{BE(sat)}$	$I_C=-10\text{mA}, I_B=-0.5\text{mA}$		0.7		V
Output Capacitance	$C_{obo}$	$V_{CB}=-10\text{V}, f=1\text{MHz}, I_E=0$			2.5	pF
Current Gain-Bandwidth Product	$f_T$	$V_{CE}=-5\text{V}, I_C=-10\text{mA}, f=100\text{MHz}$	100			MHz

\*pulse test:  $PW \leq 350\mu\text{s}$ ,  $\delta \leq 2\%$ .

## Typical Characteristics

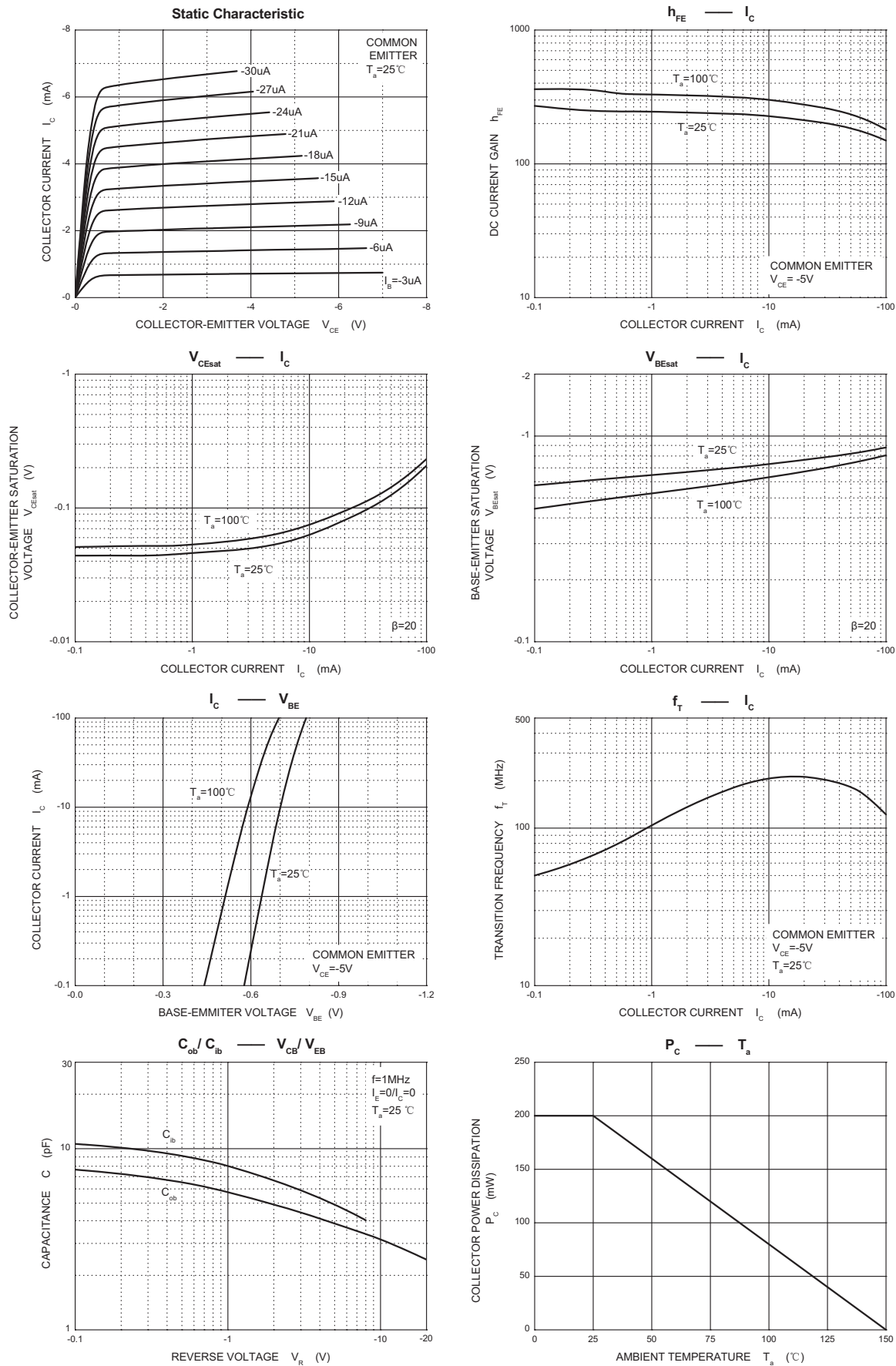

### SOT-363 Package Outline Dimensions

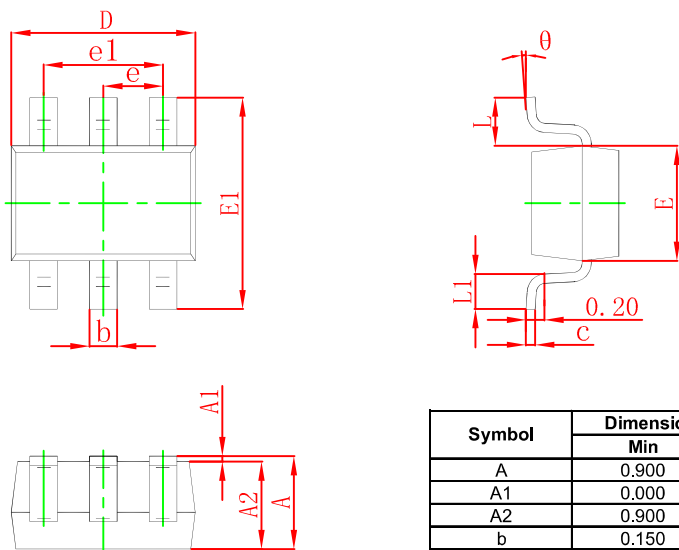

Symbol	Dimensions In Millimeters		Dimensions In Inches	
	Min	Max	Min	Max
A	0.900	1.100	0.035	0.043
A1	0.000	0.100	0.000	0.004
A2	0.900	1.000	0.035	0.039
b	0.150	0.350	0.006	0.014
c	0.100	0.150	0.004	0.006
D	2.000	2.200	0.079	0.087
E	1.150	1.350	0.045	0.053
E1	2.150	2.400	0.085	0.094
e	0.650 TYP		0.026 TYP	
e1	1.200	1.400	0.047	0.055
L	0.525 REF		0.021 REF	
L1	0.260	0.460	0.010	0.018
theta	0°	8°	0°	8°

### SOT-363 Suggested Pad Layout

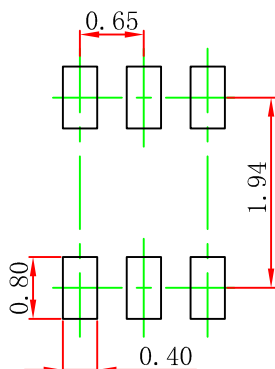

**Note:**

1. Controlling dimension: in millimeters.
2. General tolerance:  $\pm 0.05$ mm.
3. The pad layout is for reference purposes only.

**SOT-363 Tape and Reel**

**SOT-363 Embossed Carrier Tape**

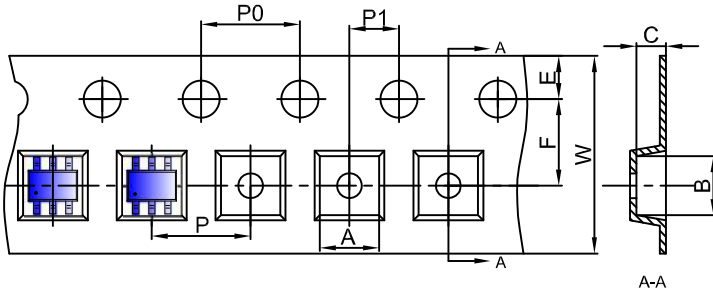

**Packaging Description:**

SOT-363 parts are shipped in tape. The carrier tape is made from a dissipative (carbon filled) polycarbonate resin. The cover tape is a multilayer film (Heat Activated Adhesive in nature) primarily composed of polyester film, adhesive layer, sealant, and anti-static sprayed agent. These reeled parts in standard option are shipped with 3,000 units per 7" or 17.8cm diameter reel. The reels are clear in color and is made of polystyrene plastic (anti-static coated).

Dimensions are in millimeter										
Pkg type	A	B	C	d	E	F	P0	P	P1	W
SOT-363	2.25	2.55	1.20	Ø1.50	1.75	3.50	4.00	4.00	2.00	8.00

**SOT-363 Tape Leader and Trailer**

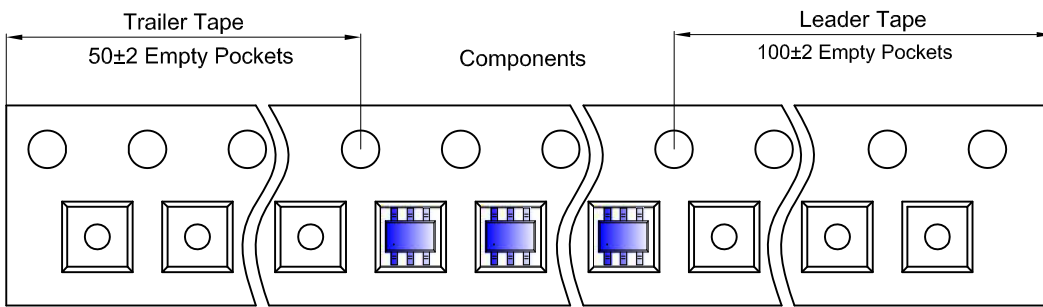

**SOT-363 Reel**

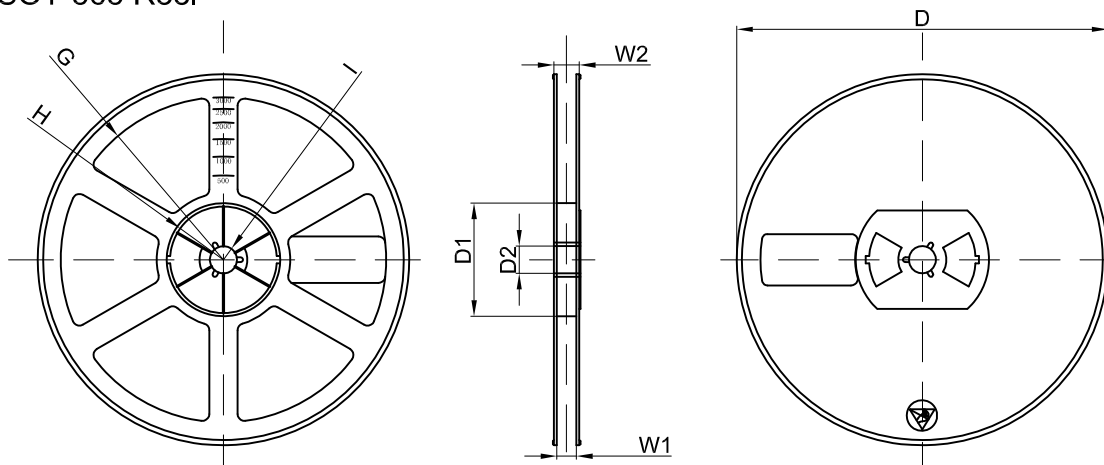

Dimensions are in millimeter								
Reel Option	D	D1	D2	G	H	I	W1	W2
7" Dia	Ø178.00	54.40	13.00	R78.00	R25.60	R6.50	9.50	12.30

REEL	Reel Size	Box	Box Size(mm)	Carton	Carton Size(mm)	G.W.(kg)
3000 pcs	7 inch	45,000 pcs	203×203×195	180,000 pcs	438×438×220	