

## SOT-323 Plastic-Encapsulate Transistors

TRANSISTOR (PNP)

### Features:

- Ideally suited for automatic insertion
- For Switching and AF Amplifier Applications

### SOT-323

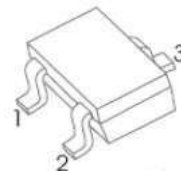

1. BASE
2. EMITTER
3. COLLECTOR

### DEVICE MARKING

BC856AW=3A; BC856BW=3B;  
 BC857AW=3E; BC857BW=3F; BC857CW=3G;  
 BC858AW=3J; BC858BW=3K; BC858CW=3L

### MAXIMUM RATINGS (T<sub>a</sub>=25°C unless otherwise noted)

Symbol	Parameter	Value	Unit
V <sub>CBO</sub>	Collector-Base Voltage		
	BC856W	-80	V
	BC857W	-50	
	BC858W	-30	
V <sub>CEO</sub>	Collector-Emitter Voltage		
	BC856W	-65	V
	BC857W	-45	
	BC858W	-30	
V <sub>EBO</sub>	Emitter-Base Voltage	-5	V
I <sub>C</sub>	Collector Current –Continuous	-0.1	A
P <sub>C</sub>	Collector Power Dissipation	150	mW
R <sub>θJA</sub>	Thermal Resistance From Junction To Ambient	833	°C/W
T <sub>J</sub>	Junction Temperature	150	°C
T <sub>stg</sub>	Storage Temperature	-65 ~ +150	°C

**ELECTRICAL CHARACTERISTICS (T<sub>a</sub>=25°C unless otherwise specified)**

Parameter	Symbol	Test conditions	Min	Max	Unit
Collector-base breakdown voltage	BC856W BC857W BC858W	V <sub>CBO</sub>	I <sub>C</sub> = -10μA, I <sub>E</sub> =0	-80 -50 -30	V
Collector-emitter breakdown voltage	BC856W BC857W BC858W	V <sub>CEO</sub>	I <sub>C</sub> = -10mA, I <sub>B</sub> =0	-65 -45 -30	V
Emitter-base breakdown voltage		V <sub>EBO</sub>	I <sub>E</sub> = -1μA, I <sub>C</sub> =0	-5	V
Collector cut-off current		I <sub>CBO</sub>	V <sub>CB</sub> = -30 V, I <sub>E</sub> =0	-15	nA
DC current gain	BC856AW, 857AW,858AW BC856BW, 857BW,858BW BC857CW,BC858CW	h <sub>FE</sub>	V <sub>CE</sub> = -5V, I <sub>C</sub> = -2mA	125 220 420	250 475 800
Collector-emitter saturation voltage		V <sub>CE(sat)</sub>	I <sub>C</sub> =-100mA, I <sub>B</sub> = -5mA	-0.65	V
Base-emitter saturation voltage		V <sub>BE(sat)</sub>	I <sub>C</sub> = -100mA, I <sub>B</sub> = -5mA	-1.1	V
Transition frequency		f <sub>T</sub>	V <sub>CE</sub> = -5V, I <sub>C</sub> = -10mA f=100MHz	100	MHz
Collector capacitance		C <sub>ob</sub>	V <sub>CB</sub> =-10V, f=1MHz	4.5	pF

### Typical Characteristics

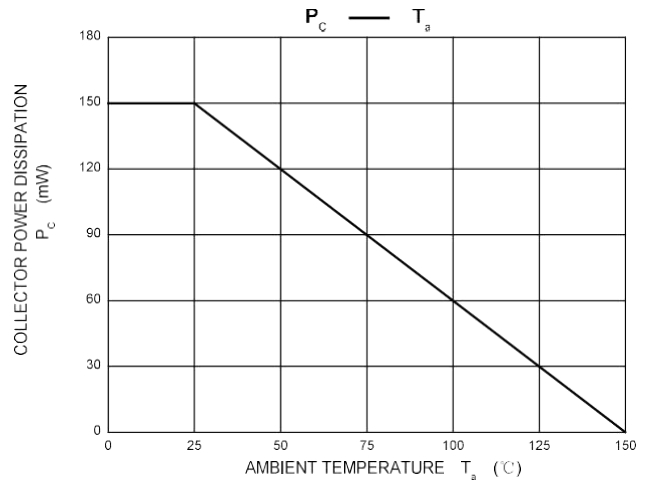
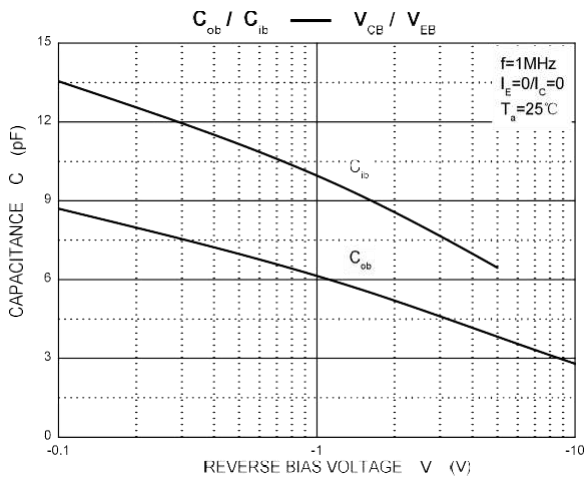
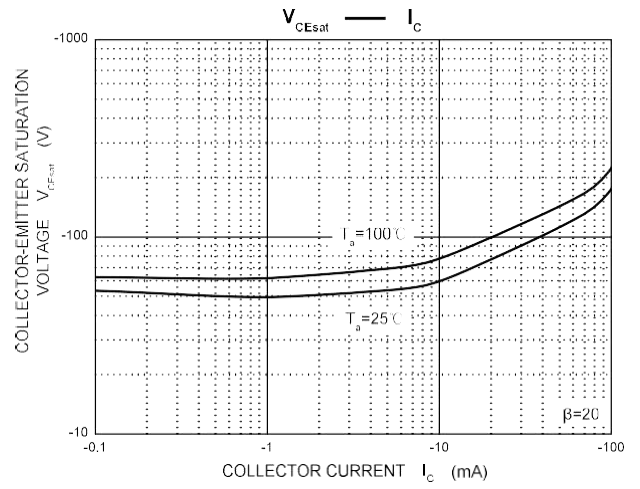
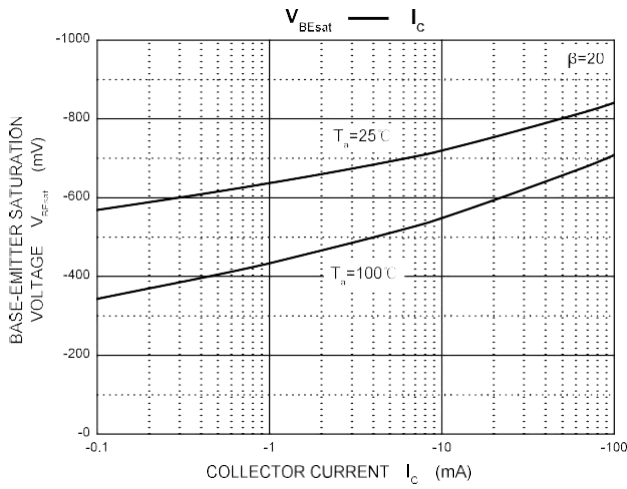
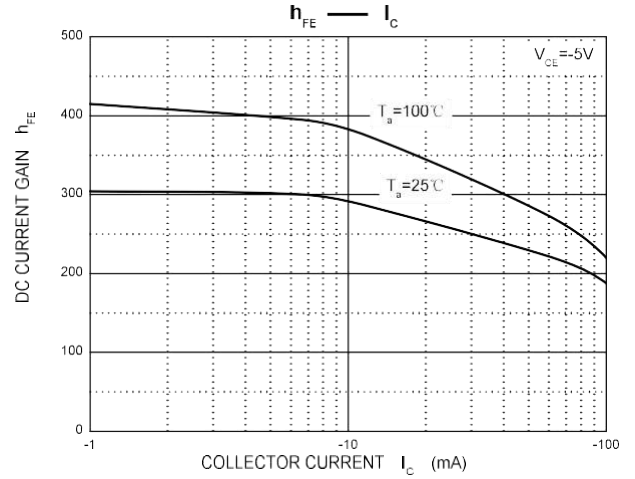
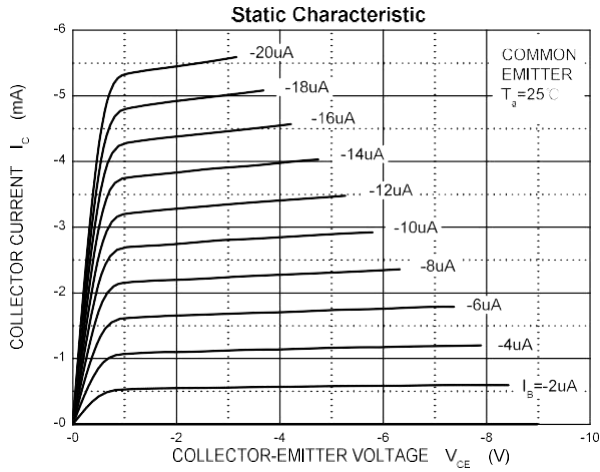

### SOT-323 Package Outline Dimensions

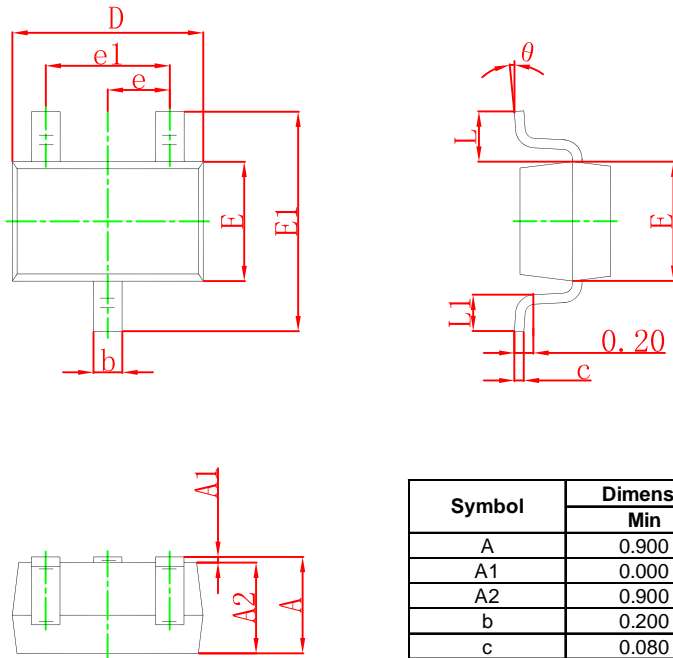

Symbol	Dimensions In Millimeters		Dimensions In Inches	
	Min	Max	Min	Max
A	0.900	1.100	0.035	0.043
A1	0.000	0.100	0.000	0.004
A2	0.900	1.000	0.035	0.039
b	0.200	0.400	0.008	0.016
c	0.080	0.150	0.003	0.006
D	2.000	2.200	0.079	0.087
E	1.150	1.350	0.045	0.053
E1	2.150	2.450	0.085	0.096
e	0.650 TYP		0.026 TYP	
e1	1.200	1.400	0.047	0.055
L	0.525 REF		0.021 REF	
L1	0.260	0.460	0.010	0.018
theta	0°	8°	0°	8°

### SOT-323 Suggested Pad Layout

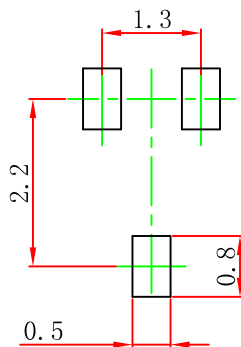

- Note:
1. Controlling dimension: in millimeters.
  2. General tolerance:  $\pm 0.05$  mm.
  3. The pad layout is for reference purposes only.

## SOT-323 Tape and Reel

### SOT-323 Embossed Carrier Tape

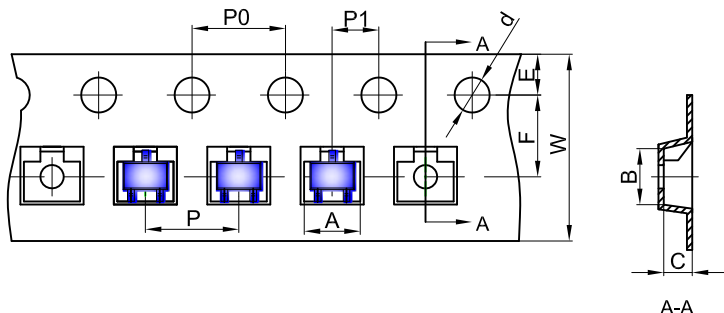

**Packaging Description:**

SOT-323 parts are shipped in tape. The carrier tape is made from a dissipative (carbon filled) polycarbonate resin. The cover tape is a multilayer film (Heat Activated Adhesive in nature) primarily composed of polyester film, adhesive layer, sealant, and anti-static sprayed agent. These reeled parts in standard option are shipped with 3,000 units per 7" or 17.8cm diameter reel. The reels are clear in color and is made of polystyrene plastic (anti-static coated).

Dimensions are in millimeter										
Pkg type	A	B	C	d	E	F	P0	P	P1	W
SOT-323	2.25	2.55	1.19	Ø1.55	1.75	3.50	4.00	4.00	2.00	8.00

### SOT-323 Tape Leader and Trailer

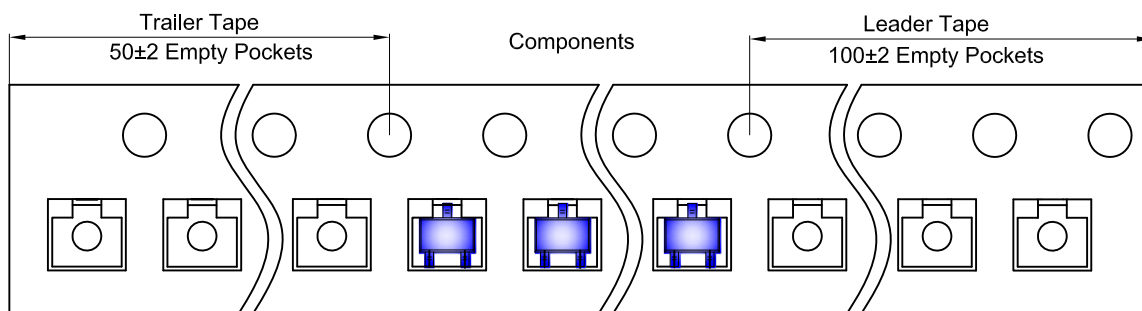

### SOT-323 Reel

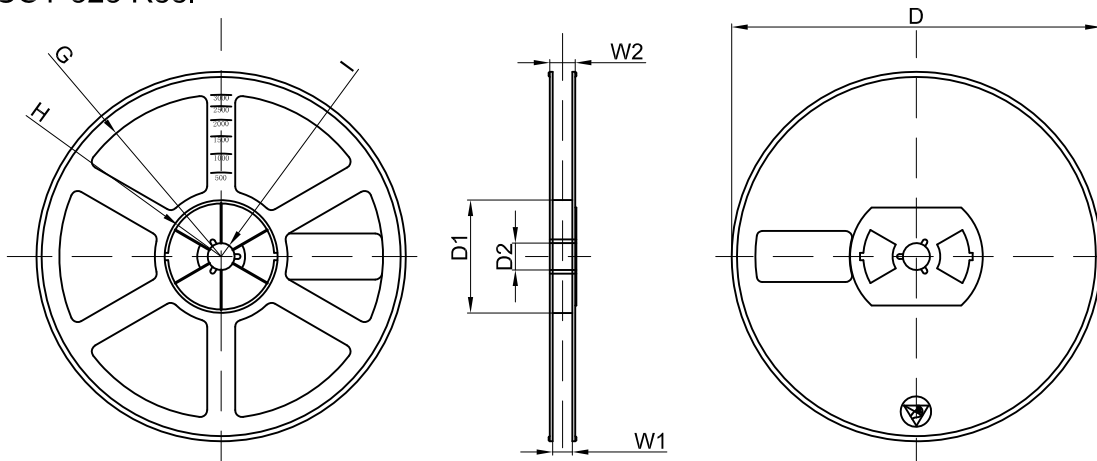

Dimensions are in millimeter								
Reel Option	D	D1	D2	G	H	I	W1	W2
7"Dia	Ø178.00	54.40	13.00	R78.00	R25.60	R6.50	9.50	12.30

REEL	Reel Size	Box	Box Size(mm)	Carton	Carton Size(mm)	G.W.(kg)
3000 pcs	7 inch	45,000 pcs	203×203×195	180,000 pcs	438×438×220	