

TO-92MOD Plastic-Encapsulate Transistors

TRANSISTOR (NPN)

Features:

- Low Frequency Power Amplifier
- Complementary Pair with 2SB647/A

TO-92MOD

1. EMITTER
2. COLLECTOR
3. BASE

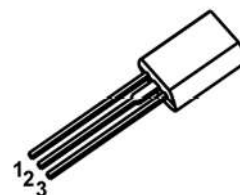

MARKING



Equivalent Circuit

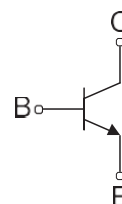

ORDERING INFORMATION

Part Number	Package	Packing Method	Pack Quantity
2SD667	TO-92MOD	Bulk	500pcs/Bag
2SD667-TA	TO-92MOD	Tape	2000pcs/Box
2SD667A	TO-92MOD	Bulk	500pcs/Bag
2SD667A-TA	TO-92MOD	Tape	2000pcs/Box

MAXIMUM RATINGS (T_a=25°C unless otherwise noted)

Symbol	Parameter	Value	Unit
V _{CB0}	Collector- Base Voltage	120	V
V _{CEO}	Collector-Emitter Voltage	2SD667	80
		2SD667A	100
V _{EBO}	Emitter-Base Voltage	5	V
I _c	Collector Current -Continuous	1	A
P _c	Collector Power Dissipation	900	mW
T _J , T _{stg}	Operation Junction and Storage Temperature Range	-55-150	°C

ELECTRICAL CHARACTERISTICS

$T_a=25\text{ C}$ unless otherwise specified

Parameter	Symbol	Test conditions	Min	Typ	Max	Unit
Collector-base breakdown voltage	$V_{(BR)CBO}$	$I_C=10\mu A, I_E=0$	120			V
Collector-emitter breakdown voltage	$V_{(BR)CEO}$	$I_C=1\text{mA}, I_B=0$	2SD667	80		V
			2SD667A	100		V
Emitter-base breakdown voltage	$V_{(BR)EBO}$	$I_E=10\mu A, I_C=0$	5			V
Collector cut-off current	I_{CBO}	$V_{CB}=100\text{V}, I_E=0$			10	μA
Emitter cut-off current	I_{EBO}	$V_{EB}=4\text{V}, I_C=0$			10	μA
DC current gain	$h_{FE(1)}$	$V_{CE}=5\text{V}, I_C=150\text{mA}$	2SD667	60	320	
			2SD667A	60	320	
	$h_{FE(2)}$	$V_{CE}=5\text{V}, I_C=500\text{mA}$	30			
Collector-emitter saturation voltage	$V_{CE(sat)}$	$I_C=500\text{mA}, I_B=50\text{mA}$			1	V
Base-emitter voltage	V_{BE}	$V_{CE}=5\text{V}, I_C=150\text{mA}$			1.5	V
Transition frequency	f_T	$V_{CE}=5\text{V}, I_C=150\text{mA}$		140		MHz
Collector output capacitance	C_{ob}	$V_{CB}=10\text{V}, I_E=0, f=1\text{MHz}$		12		pF

CLASSIFICATION OF $h_{FE(1)}$

Rank		B	C	D
Range	2SD667	60-120	100-200	160-320
	2SD667A	60-120	100-200	160-320

Typical Characteristics

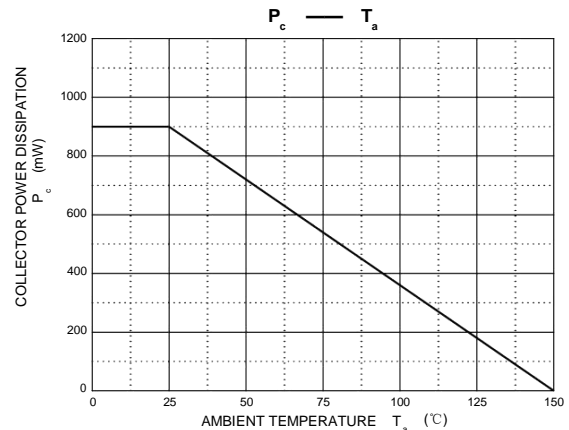
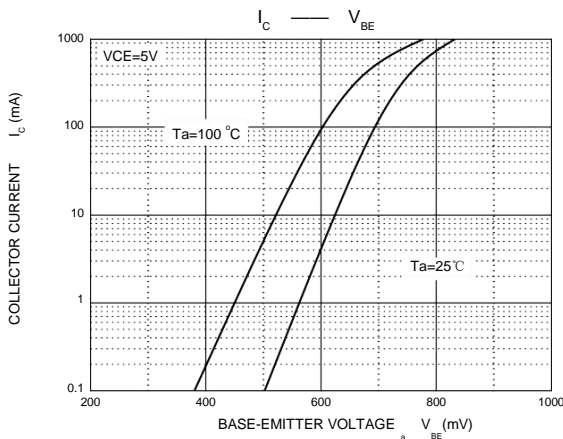
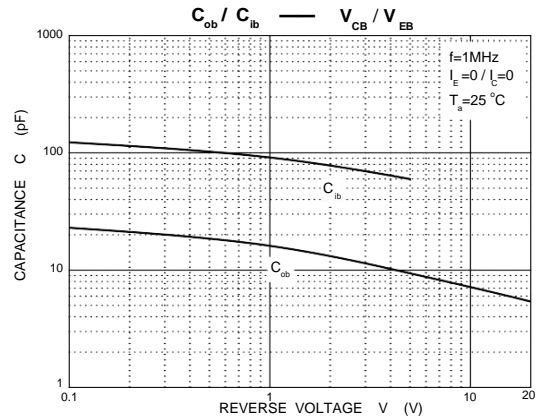
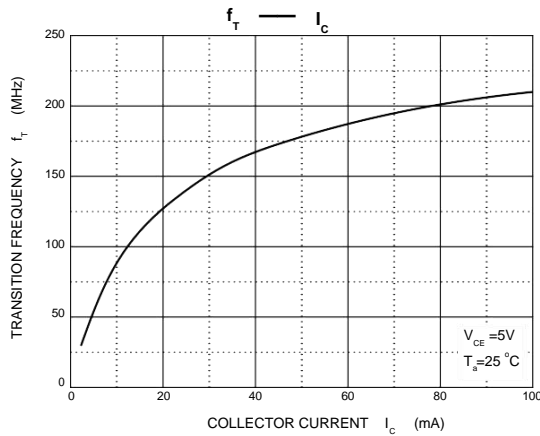
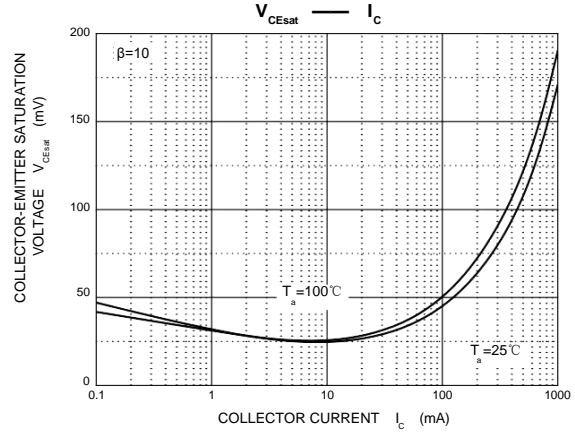
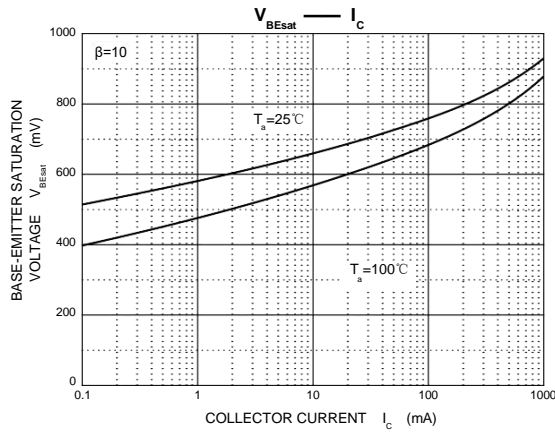
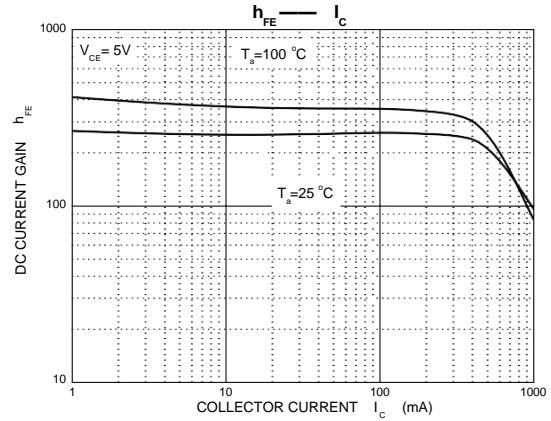
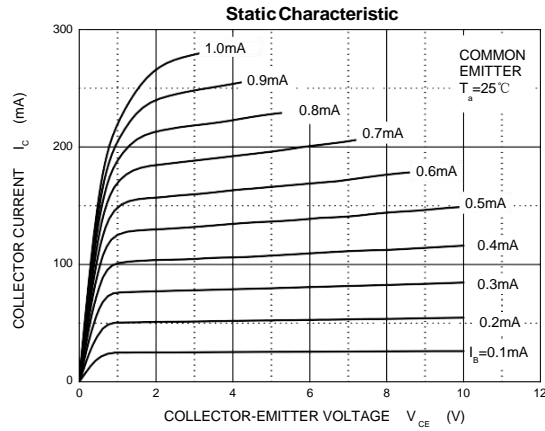

TO-92MOD Package Outline Dimensions

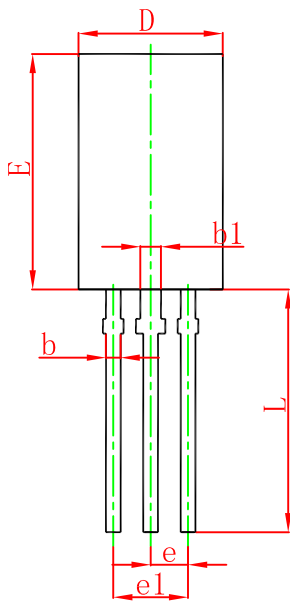
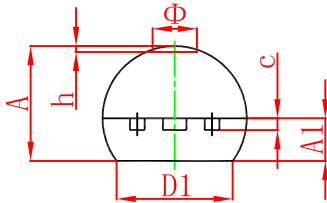

Symbol	Dimensions In Millimeters		Dimensions In Inches	
	Min.	Max.	Min.	Max.
A	4.800	5.000	0.189	0.197
A1	1.730	2.030	0.068	0.080
b	0.440	0.600	0.017	0.024
b1	0.940	1.100	0.037	0.043
c	0.350	0.450	0.014	0.018
D	5.900	6.100	0.232	0.240
D1	4.000		0.157	
E	8.500	8.700	0.335	0.343
e	1.500 TYP.		0.059 TYP.	
e1	2.900	3.100	0.114	0.122
L	13.800	14.200	0.543	0.559
Φ		1.600		0.063
h	0.000	0.380	0.000	0.015

TO-92MOD Suggested Pad Layout

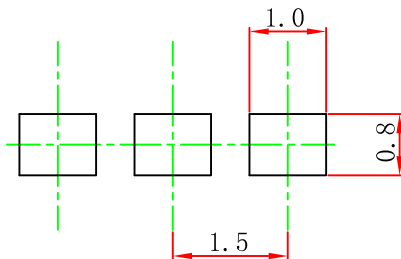

- Note:
1. Controlling dimension: in millimeters.
 2. General tolerance: $\pm 0.05\text{mm}$.
 3. The pad layout is for reference purposes only.

TO-92MOD PACKAGE TAPING DIMENSION

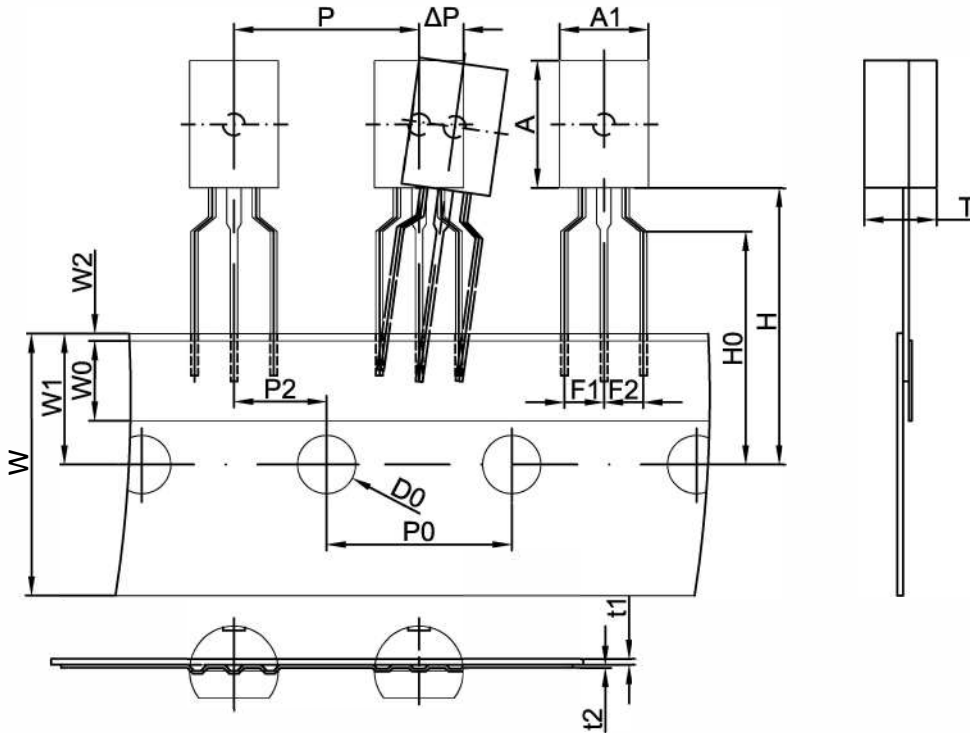

Dimensions are in millimeter								
A1	A	T	P	P0	P2	F1	F2	W
6.0	8.6	4.9	12.7	12.7	6.35	2.5	2.5	18.0
W0	W1	W2	H	H0	D0	t1	t2	ΔP
6.0	9.0	1.0	19.0	16.0	4.0	0.4	0.2	0

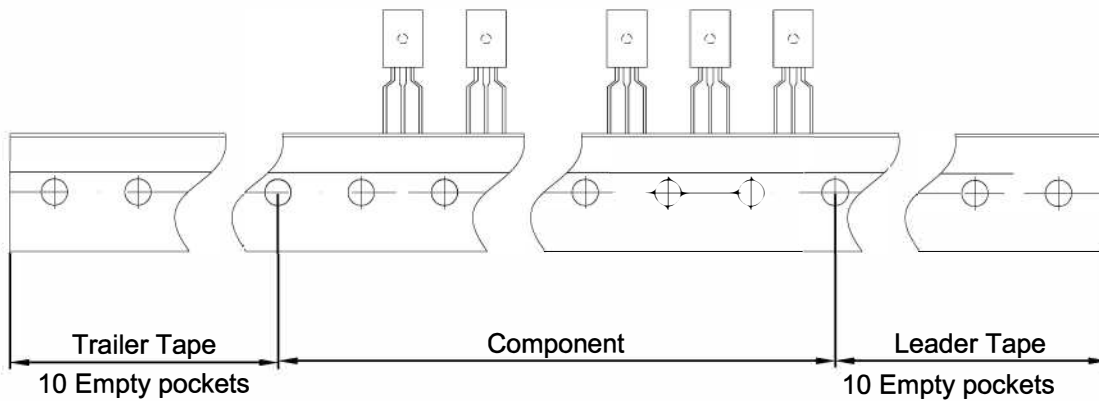

Package	Box	Box Size(mm)	Carton	Carton Size(mm)
TO-92MOD	2000 pcs	333×245×43	20,000 pcs	573×404×266