

SMB Plastic-Encapsulate Diodes

Schottky Rectifier Diode

Features:

- $I_{F(AV)}$ 5A
- V_{RRM} 40V
- High surge current capability
- Polarity: Color band denotes cathode
- Low peak forward voltage

Applications:

- Rectifier

Marking

- SS54L:SS54L

SMB



Limiting Values(Absolute Maximum Rating)

Item	Symbol	Unit	Test Conditions	KSS54L
Repetitive Peak Reverse Voltage	V_{RRM}	V		40
Maximum RMS Voltage	V_{RMS}	V		28
Average Forward Current	$I_{F(AV)}$	A	60Hz Half-sine wave, Resistance load	5.0
Surge(Non-repetitive)Forward Current	I_{FSM}	A	60Hz Half-sine wave, 1 cycle, $T_a=25^{\circ}C$	120
Junction Temperature	T_J	$^{\circ}C$		-55 ~ +150
Storage Temperature	T_{STG}	$^{\circ}C$		-55 ~ +150

Electrical Characteristics (T=25 $^{\circ}C$ Unless otherwise specified)

Item	Symbol	Unit	Test Condition		KSS54L
Peak Forward Voltage	V_F	V	$I_F=5.0A$	$T_a=25^{\circ}C$	0.45
Peak Reverse Current	I_{RRM1}	mA	$V_{RM}=V_{RRM}$	$T_a=25^{\circ}C$	0.10
	I_{RRM2}			$T_a=100^{\circ}C$	10.0
Thermal Resistance(Typical)	$R_{\theta J-A}$	$^{\circ}C/W$	Between junction and ambient		55
	$R_{\theta J-L}$		Between junction and lead		13
Juction Capacitance (Typical)	C_j	pF	Measured at 1MHZ and Applied Reverse Voltage of 4.0 V.D.C		420

Notes:

Thermal resistance from junction to ambient and from junction to lead mounted on FR4 PCB double sided copper mini pad

Typical Characteristics

FIG.1: FORWARD CURRENT DERATING CURVE

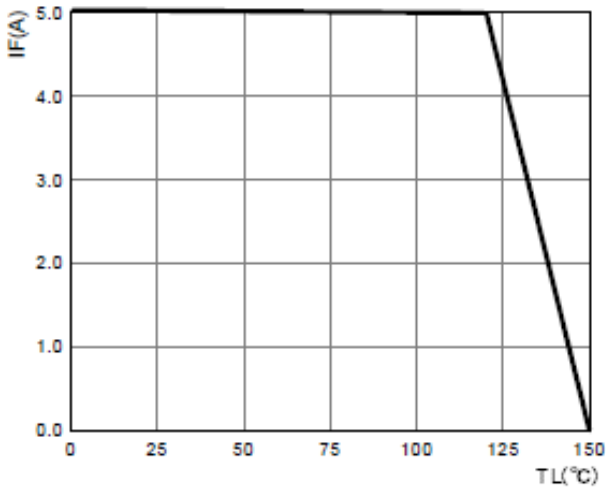

FIG.2: MAXIMUM NON-REPETITIVE FORWARD SURGE CURRENT

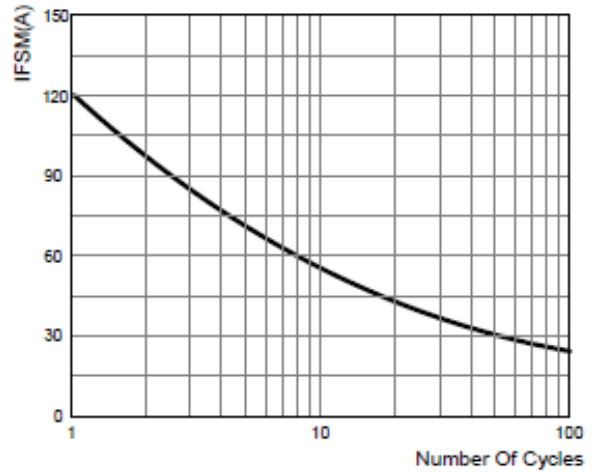

FIG.3: TYPICAL FORWARD CHARACTERISTICS

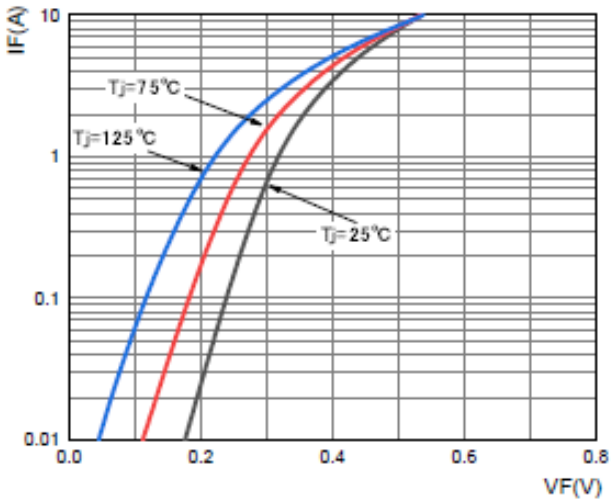
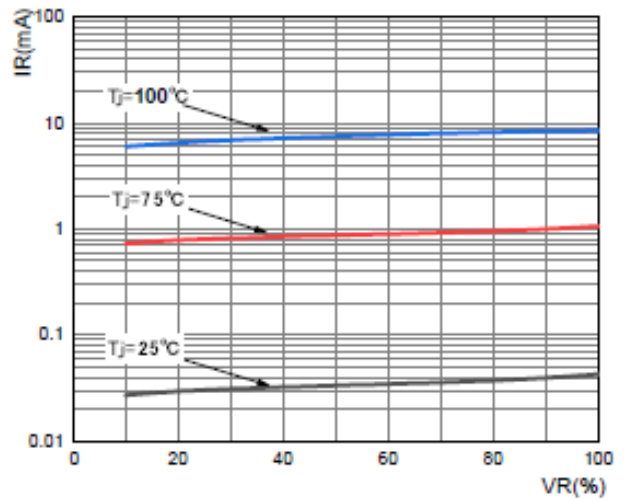
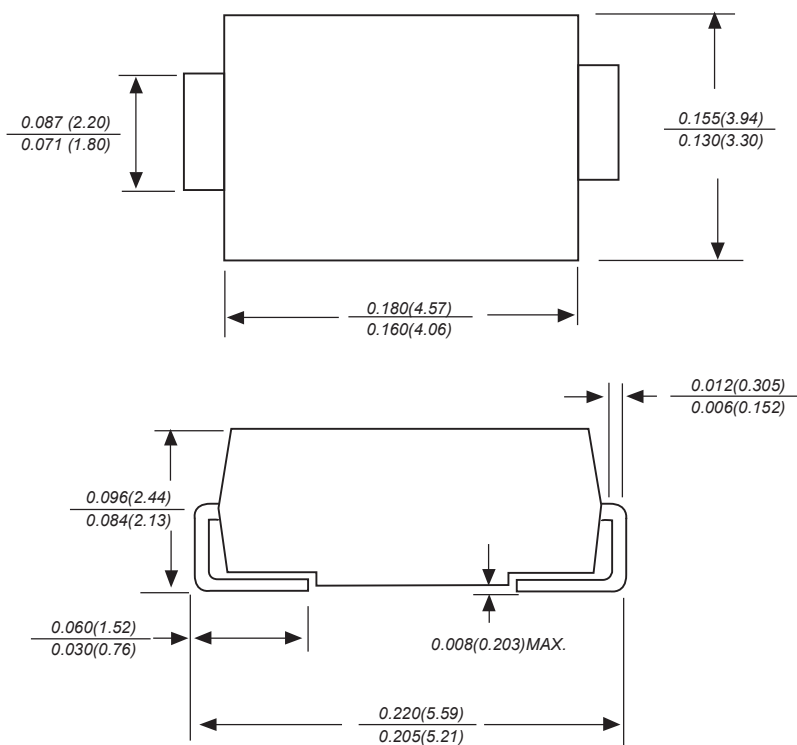

FIG.4: TYPICAL REVERSE CHARACTERISTICS



SMB Package Outline Dimensions



Dimensions in inches and (millimeters)

SMB Suggested Pad Layout

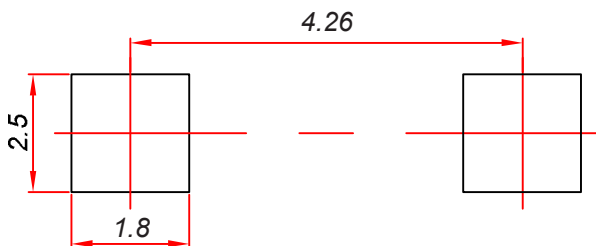

- Note:**
1. Controlling dimension: in millimeters.
 2. General tolerance: $\pm 0.05 \text{ mm}$.
 3. The pad layout is for reference purposes only.

Reel Taping Specifications For Surface Mount Devices-SMB

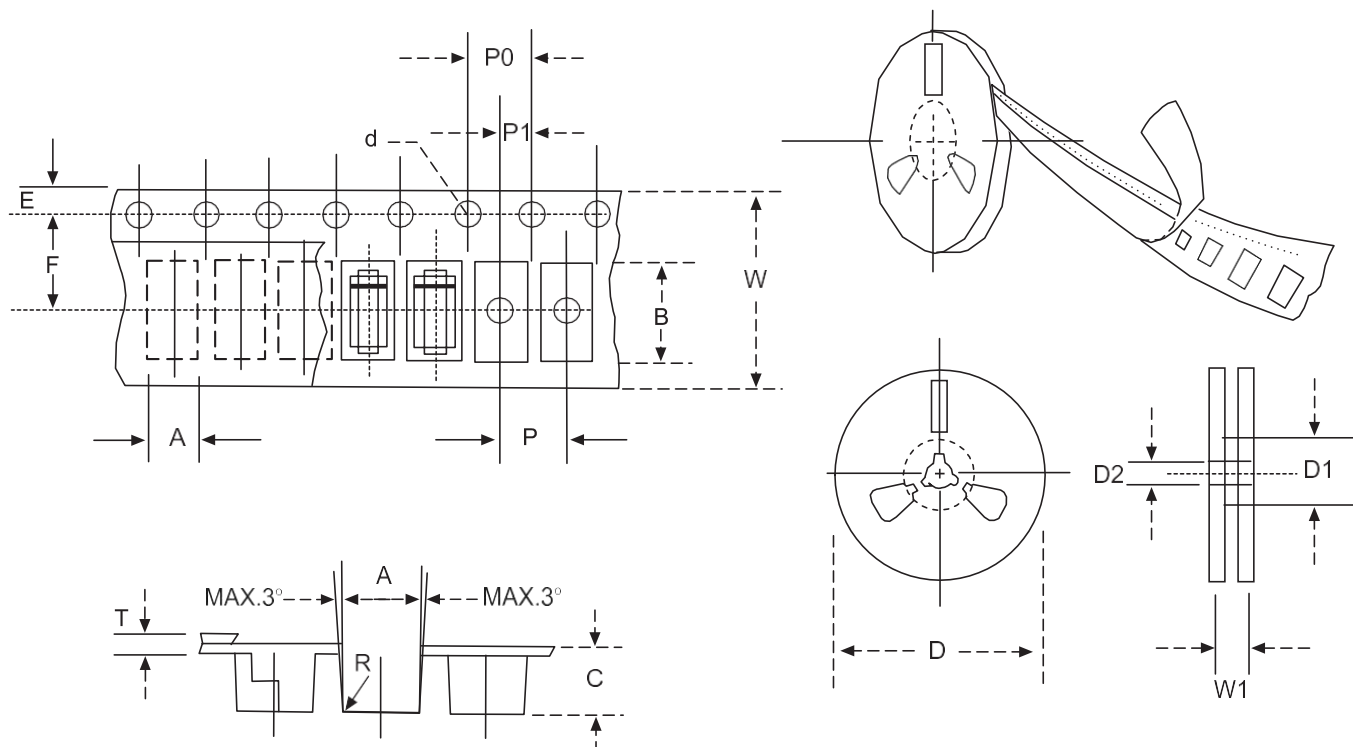

FIG: CONFIGURATION OF SURFACE MOUNTED DEVICES TAPING

ITEM	SYMBOL	SMBG mm(inch)
Carrier width	A	4.09±0.1(0.161±0.004)
Carrier length	B	5.82±0.1(0.229±0.004)
Carrier depth	C	2.50±0.1(0.100±0.004)
Sprocket hole	d	1.55±0.05(0.061±0.002)
Reel outside diameter	D	330±2.0(13±0.079)
Reel inner diameter	D1	75±1.0 (2.95 ±0.039)
Feed hole diameter	D2	13±0.5(0.512±0.020)
Sprocket hole position	E	1.75±0.1(0.069±0.004)
Punch hole position	F	5.65±0.05(0.222±0.002)
Punch hole pitch	P	8.0±0.1(0.315±0.004)
Sprocket hole pitch	P0	4.0±0.1(0.157±0.004)
Embossment center	P1	2.0±0.1(0.079±0.004)
Totall tape thickness	T	0.32±0.1(0.013±0.004)
Tape width	W	12.0±0.2(0.472±0.008)
Reel width	W1	16.8±2.0(0.661±0.079)

NOTE: Devices are packed in accordance with EIA standard RS-481-A and specification given above.