

TO-252-2L Plastic-Encapsulate Diodes

SCHOTTKY BARRIER RECTIFIER

Features:

- Low Power Loss, High Efficiency
- Guard Ring Die Construction for Transient Protection
- High Current Capability and Low Forward Voltage Drop

TO-252-2L

1. ANODE
 2. CATHODE
 3. ANODE

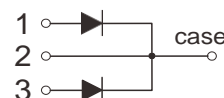
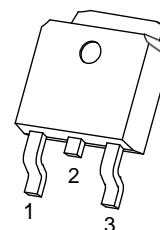

MARKING



SRD20150CT= Device code
 XXXX= Code

MAIN CHARACTERISTICS

I_o	20 (2x10) A
V_{RRM}	150 V
T_j	150 °C
$V_{F(typ)}$	0.71V (@T_j=125°C)

MAXIMUM RATINGS (T_a=25°C unless otherwise noted)

Symbol	Parameter	Value	Unit
V_{RRM}	Peak repetitive reverse voltage	150	V
V_{RWM}	Working peak reverse voltage		
V_R	DC blocking voltage		
$V_{R(RMS)}$	RMS reverse voltage	105	V
I_o	Average rectified output current	20	A
I_{FSM}	Non-Repetitive peak forward surge current (8.3ms half sine wave)	150	A
$R_{\theta JC}$	Thermal resistance from junction to case	3.0	°C/W
$R_{\theta JA}$	Thermal resistance from junction to ambient	100	°C/W
T_j	Junction temperature	150	°C
T_{stg}	Storage temperature	-55~+150	°C

ELECTRICAL CHARACTERISTICS (T_a=25°C unless otherwise specified)

Parameter	Symbol	Test conditions	Min	Typ	Max	Unit
Reverse voltage	$V_{(BR)}$	$I_R=0.1mA$	150			V
Reverse current	I_R	$V_R=150V$	$T_j=25^\circ C$	2.0	100	uA
			$T_j=125^\circ C$	2.0		mA
Forward voltage	V_F	$I_F=5A$	$T_j=25^\circ C$	0.76		V
			$T_j=125^\circ C$	0.64		V
		$I_F=10A$	$T_j=25^\circ C$	0.83	0.9	V
			$T_j=125^\circ C$	0.71		V

*Pulse test: pulse width $\leq 300\mu s$, duty cycles $\leq 2.0\%$.

Typical Characteristics

FIG.1: FORWARD CURRENT DERATING CURVE

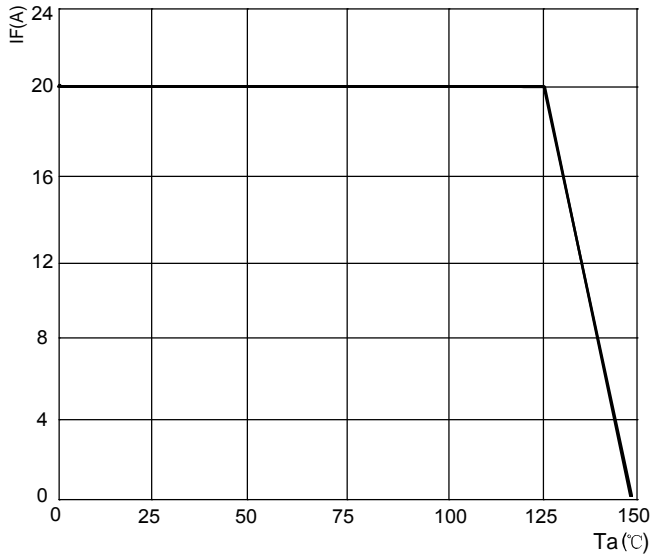

FIG.2: TYPICAL FORWARD CHARACTERISTICS

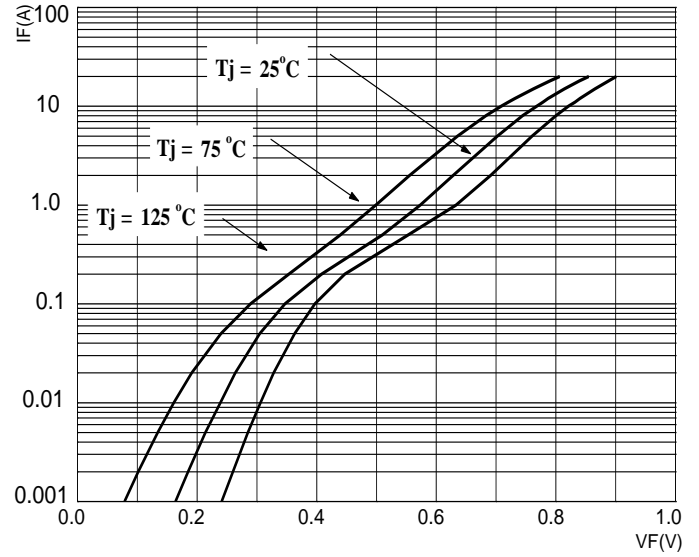

FIG.3: TOTAL CAPACITANCE DERATING CURVE

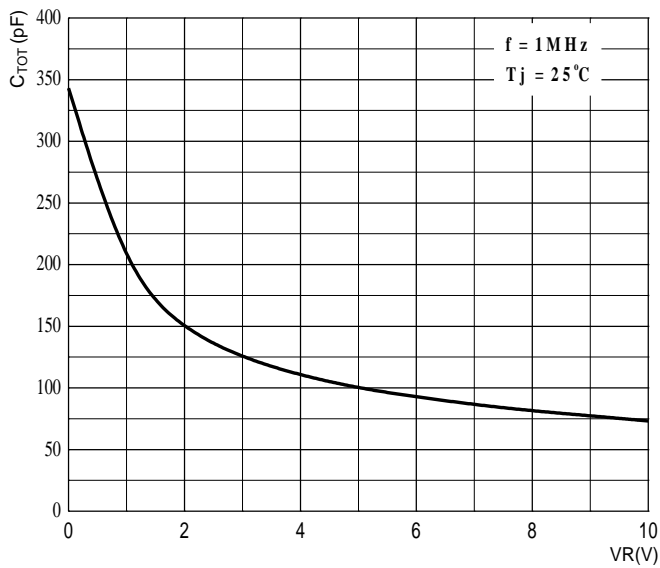
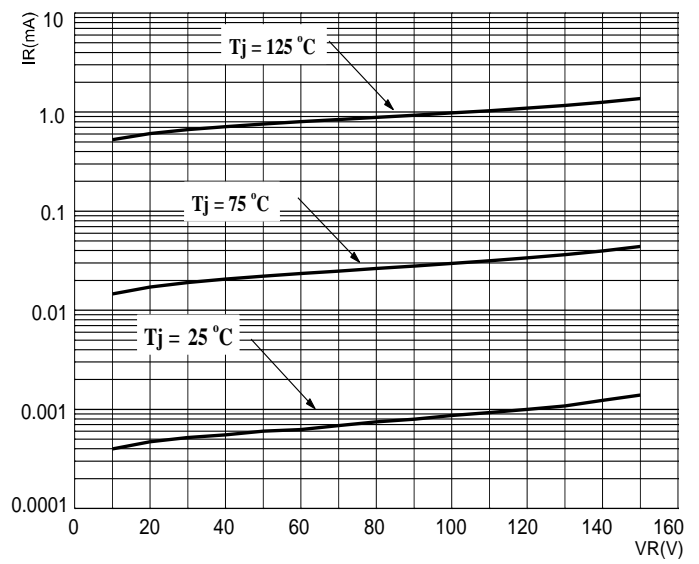
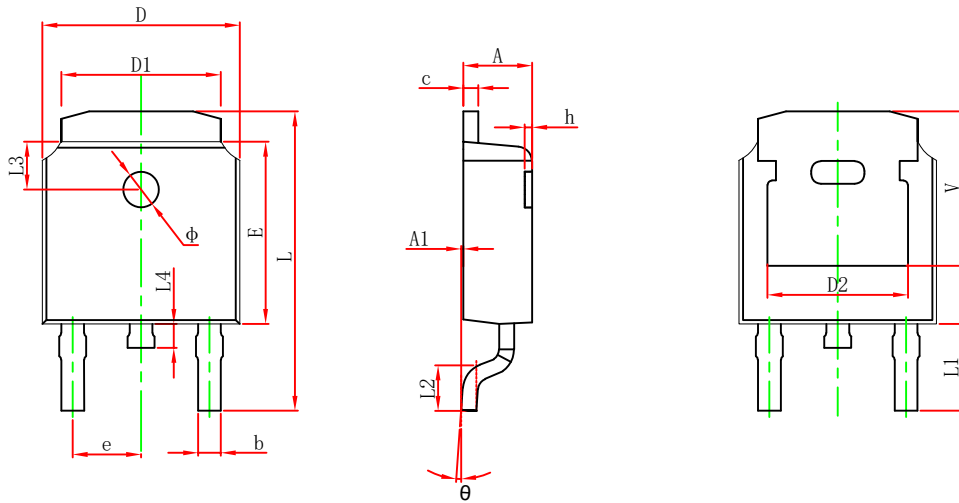

FIG.4: TYPICAL REVERSE CHARACTERISTICS



TO-252-2L Package Outline Dimensions



Symbol	Dimensions In Millimeters		Dimensions In Inches	
	Min.	Max.	Min.	Max.
A	2.200	2.400	0.087	0.094
A1	0.000	0.127	0.000	0.005
b	0.635	0.770	0.025	0.030
c	0.460	0.580	0.018	0.023
D	6.500	6.700	0.256	0.264
D1	5.100	5.460	0.201	0.215
D2	4.830 REF.		0.190 REF.	
E	6.000	6.200	0.236	0.244
e	2.186	2.386	0.086	0.094
L	9.712	10.312	0.382	0.406
L1	2.900 REF.		0.114 REF.	
L2	1.400	1.700	0.055	0.067
L3	1.600 REF.		0.063 REF.	
L4	0.600	1.000	0.024	0.039
φ	1.100	1.300	0.043	0.051
θ	0°	8°	0°	8°
h	0.000	0.300	0.000	0.012
V	5.250 REF.		0.207 REF.	

TO-252-2L Suggested Pad Layout

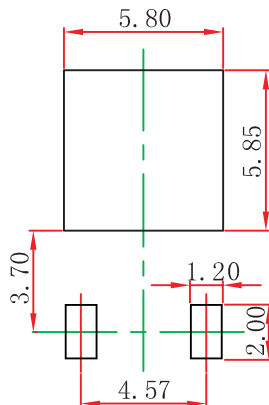

Note:

1. Controlling dimension: in millimeters.
2. General tolerance: ± 0.05mm.
3. The pad layout is for reference purposes only.

TO-252-2L Tape and Reel

TO-252 Embossed Carrier Tape

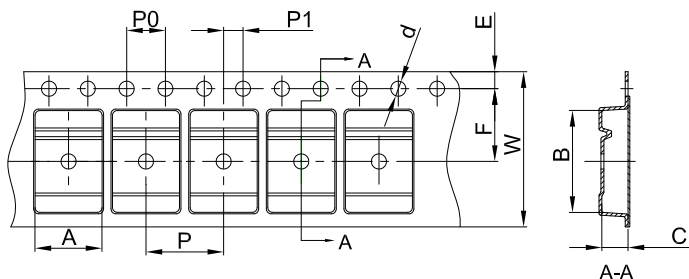

Dimensions are in millimeter										
Pkg type	A	B	C	d	E	F	P0	P	P1	W
TO-252	6.90	10.50	2.70	Ø1.55	1.75	7.50	4.00	8.00	2.00	16.00

TO-252 Tape Leader and Trailer

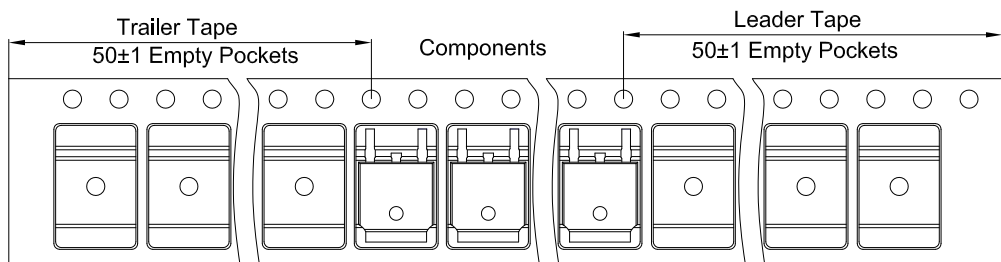

TO-252 Reel

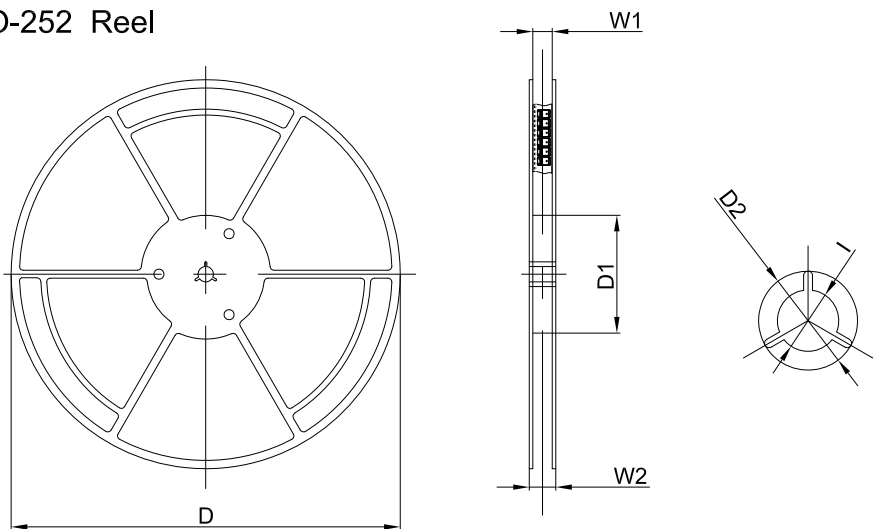

Dimensions are in millimeter						
Reel Option	D	D1	D2	W1	W2	I
13" Dia	330.00	100.00	Ø21.00	16.40	21.00	Ø13.00

REEL	Reel Size	Box	Box Size(mm)	Carton	Carton Size(mm)	G.W.(kg)
2,500 pcs	13inch	2,500 pcs	340×336×29	25,000 pcs	353×346×365	