

SOT-23 Plastic-Encapsulate Diodes

ZENER DIODE

SOT-23

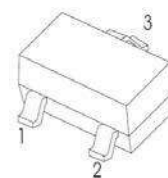

Features:

- Dual zeners common cathode configuration
- 300mW Power Dissipation
- Ideally suited for automated insertion
- Zener Voltages from 2.7V -51V
- Ultra-Small Surface Mount Package Power dissipation

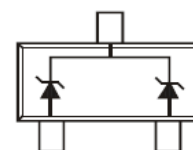

Maximum Ratings ($T_a=25^{\circ}\text{C}$ unless otherwise specified)

Characteristic	Symbol	Value	Unit
Forward Voltage @ $I_F = 10\text{mA}$	V_F	0.9	V
Power Dissipation(Note 1)	P_d	300	mW
Thermal Resistance, Junction to Ambient Air	$R_{\theta JA}$	417	$^{\circ}\text{C/W}$
Operating and Storage Temperature Range	T_j, T_{STG}	-55~ +150	$^{\circ}\text{C}$

Notes: 1. Valid provided that device terminals are kept at ambient temperature.

ELECTRICAL CHARACTERISTICS

$T_a=25^{\circ}\text{C}$ unless otherwise specified

Type Number	Marking Code	Zener Voltage Range (Note 2)	Maximum Zener Impedance (Note3)		Typical Temperature Coefficient	Min. Reverse Voltage (Note2)
		@ $I_{zT} = 5.0\text{mA}$	Z_{zT} @ $I_{zT} = 5.0\text{mA}$	Z_{zK} @ $I_{zK} = 1.0\text{mA}$		@ $I_R = 0.1\mu\text{A}$
		V_z (Volts)	Ohms	Ohms	T_c (%/ $^{\circ}\text{C}$)	V_R (Volts)
DZ23C2V7	KV1	2.5-2.9	83	500	-0.065	—
DZ23C3V0	KV2	2.8-3.2	95	500	-0.060	—
DZ23C3V3	KV3	3.1-3.5	95	500	-0.055	—
DZ23C3V6	KV4	3.4-3.8	95	500	-0.055	—
DZ23C3V9	KV5	3.7-4.1	95	500	-0.050	—
DZ23C4V3	KV6	4.0-4.6	95	500	-0.035	—
DZ23C4V7	KV7	4.4-5.0	78	500	-0.015	—
DZ23C5V1	KV8	4.8-5.4	60	480	+0.005	0.8
DZ23C5V6	KV9	5.2-6.0	40	400	+0.020	1.0
DZ23C6V2	KVA	5.8-6.6	10	200	+0.030	2.0
DZ23C6V8	KVB	6.4-7.2	8.0	150	+0.045	3.0
DZ23C7V5	KVC	7.0-7.9	7.0	50	+0.050	5.0
DZ23C8V2	KVD	7.7-8.7	7.0	50	+0.055	6.0
DZ23C9V1	KVE	8.5-9.6	10	50	+0.065	7.0
DZ23C10	KVF	9.4-10.6	15	70	+0.065	7.5
DZ23C11	KVG	10.4-11.6	20	70	+0.070	8.5
DZ23C12	KVH	11.4-12.7	20	90	+0.075	9.0
DZ23C13	KVI	12.4-14.1	25	110	+0.080	10.0
DZ23C15	KVJ	13.8-15.6	30	110	+0.080	11.0
DZ23C16	KVK	15.3-17.1	40	170	+0.090	12.0
DZ23C18	KVL	16.8-19.1	50	170	+0.090	14.0
DZ23C20	KVM	18.8-21.2	50	220	+0.090	15.0
DZ23C22	KVN	20.8-23.3	55	220	+0.090	17.0
DZ23C24	KVO	22.8-25.6	80	220	+0.090	18.0
DZ23C27	KVP	25.1-28.9	80	250	+0.090	20.0
DZ23C30	KVQ	28-32	80	250	+0.090	22.5
DZ23C33	KVR	31-35	80	250	+0.090	25.0
DZ23C36	KVS	34-38	90	250	+0.090	27.0
DZ23C39	KVT	37-41	90	300	+0.110	29.0
DZ23C43	KVU	40-46	100	700	+0.110	32.0
DZ23C47	KVV	44-50	100	750	+0.110	35.0
DZ23C51	KVW	48-54	100	750	+0.110	38.0

Notes: 2. Short duration pulse test used to minimize self-heating effect.

3. $f = 1\text{KHz}$.

Typical Characteristics

Notes: Our company currently provide 2.7V-43V products only
Zener Characteristics (V_z Up to 10 V)

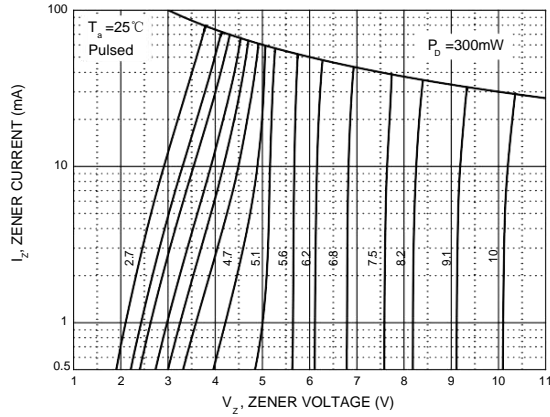

Zener Characteristics (11 V to 43 V)

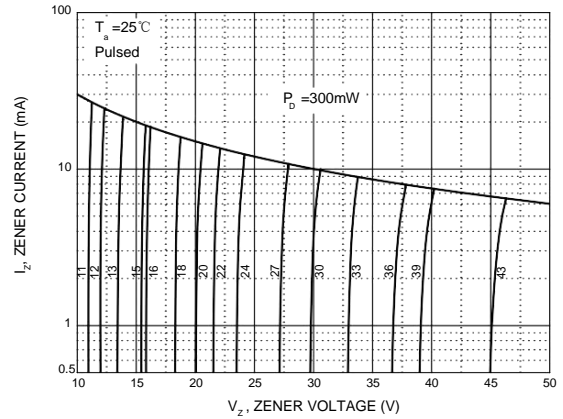

Temperature Coefficients

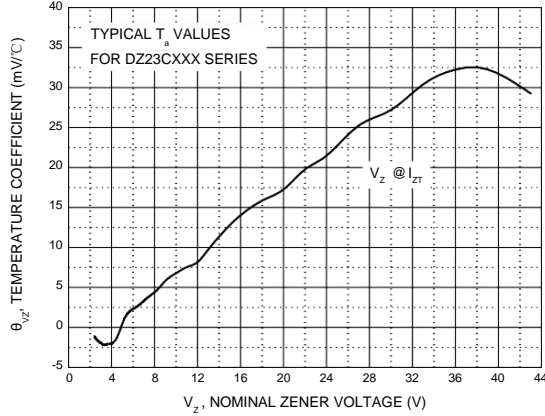

Typical Leakage Current

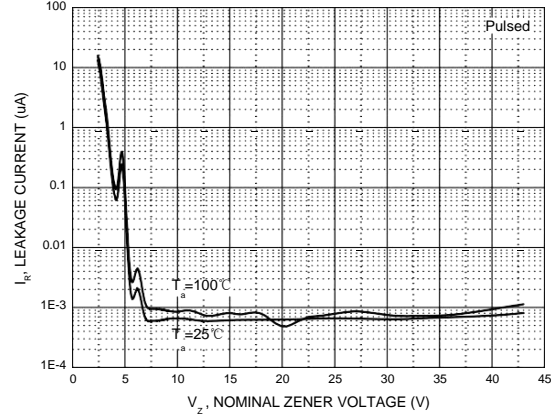

Typical Capacitance

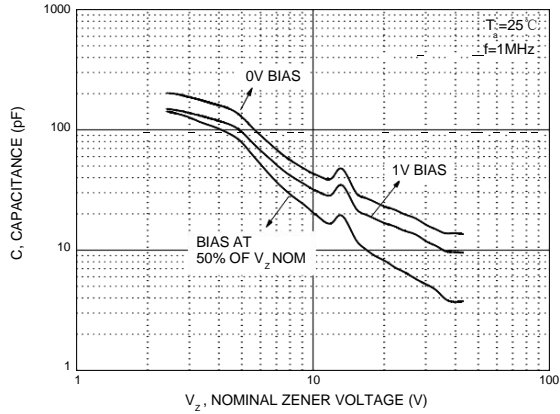

Effect of Zener Voltage on Zener Impedance

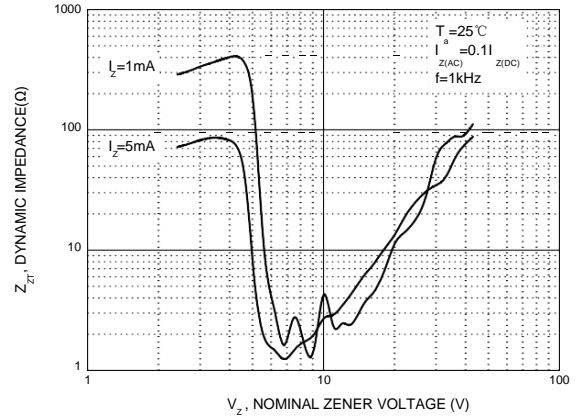

Power Derating Curve

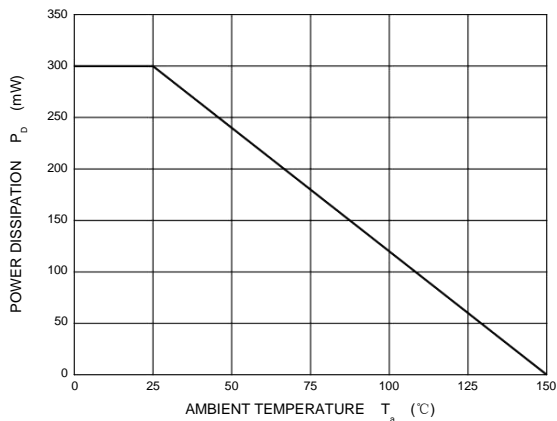

SOT-23 Package Outline Dimensions

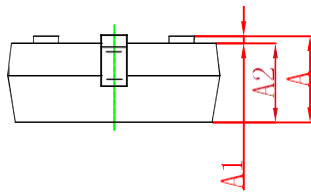
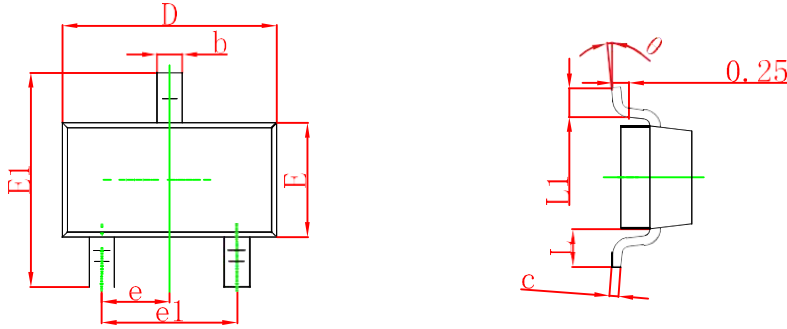

Symbol	Dimensions In Millimeters		Dimensions In Inches	
	Min	Max	Min	Max
A	0.900	1.150	0.035	0.045
A1	0.000	0.100	0.000	0.004
A2	0.900	1.050	0.035	0.041
b	0.300	0.500	0.012	0.020
c	0.080	0.150	0.003	0.006
D	2.800	3.000	0.110	0.118
E	1.200	1.400	0.047	0.055
E1	2.250	2.550	0.089	0.100
e	0.950 TYP		0.037 TYP	
e1	1.800	2.000	0.071	0.079
L	0.550 REF		0.022 REF	
L1	0.300	0.500	0.012	0.020
θ	0°	8°	0°	8°

SOT-23 Suggested Pad Layout

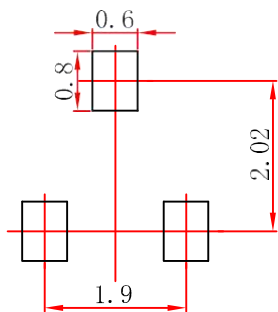

- Note:
1. Controlling dimension: In millimeters.
 2. General tolerance: $\pm 0.05\text{mm}$.
 3. The pad layout is for reference purposes only.

SOT-23 Tape and Reel

SOT-23 Embossed Carrier Tape

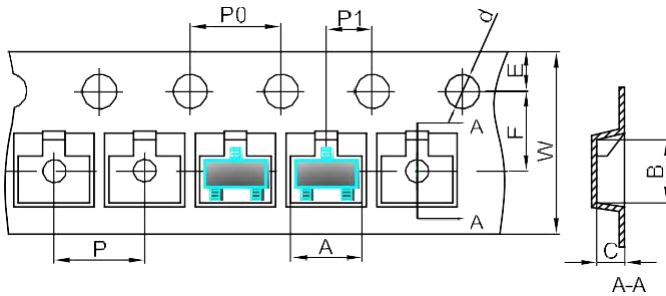

Packaging Description:

SOT-23 parts are shipped on tape. The carrier tape is made from a dissipative (carbon filled) polycarbonate resin. The cover tape is a multilayer film (Heat Activated Adhesive in nature) primarily composed of polyester film, adhesive layer, sealant, and an antistatic sprayed agent. These reeled parts in standard option are shipped with 3,000 units per 7" or 17.8cm diameter reel. The reels are clear in color and are made of polystyrene plastic (antistatic coated).

Dimensions are in millimeter

Pkg type	A	B	C	d	E	F	P0	P	P1	W
SOT-23	3.15	2.77	1.22	Ø1.50	1.75	3.50	4.00	4.00	2.00	8.00

SOT-23 Tape Leader and Trailer

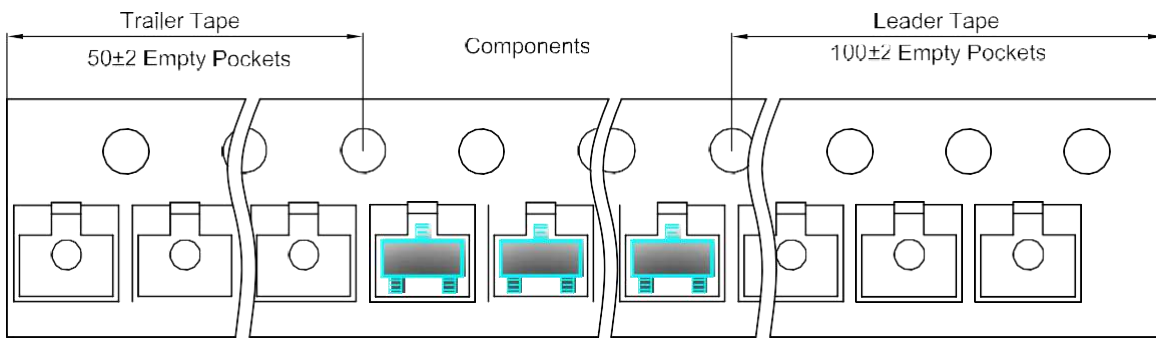

SOT-23 Reel

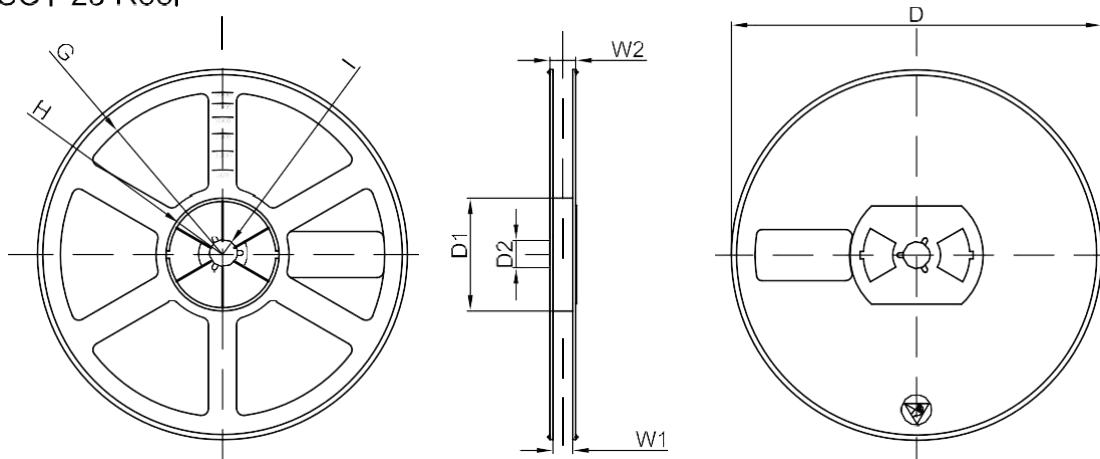

Dimensions are in millimeter

Reel Option	D	D1	D2	G	H	I	W1	W2
7" Dia	Ø178.00	54.40	13.00	R78.00	R25.60	R6.50	9.50	12.30

REEL	Reel Size	Box	Box Size(mm)	Carton	Carton Size(mm)	G.W.(kg)
3000 pcs	7 inch	45,000 pcs	203×203×195	180,000 pcs	438×438×220	