

# SCHOTTKY BARRIER RECTIFIER

## Features:

- Plastic package has Underwriters Laboratory Flammability Classification 94V-0
- Metal silicon junction ,majority carrier conduction
- Guard ring for overvoltage protection
- Low power loss ,high efficiency
- High current capability ,Low forward voltage drop
- High surge capability
- For use in low voltage ,high frequency inverters, free wheeling ,and polarity protection applications
- Dual rectifier construction
- High temperature soldering guaranteed:260°C/10 seconds,, 0.25"(6.35mm) from case
- Component in accordance to RoHS 2002/95/EC and WEEE 2002/96/EC

## TO-252

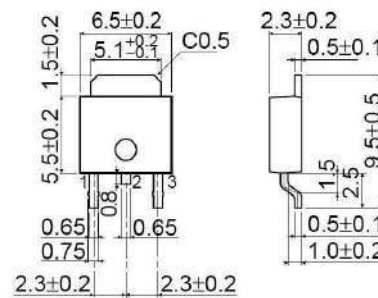

## Descriptions :

- *Case:* JEDEC TO-220AB molded plastic body
- *Terminals:* Lead solderable per MIL-STD-750,method 2026
- *Polarity:* As marked
- *Mounting Position:* Any
- *Weight:* 0.08ounce, 2.24 grams

## MAXIMUM RATINGS AND ELECTRICAL CHARACTERISTICS

(Ratings at 25°C ambient temperature unless otherwise specified ,Single phase ,half wave ,resistive or inductive load. For capacitive load,derate by 20%.)

	Symbols	KSRD 1020CT	KSRD 1030CT	KSRD 1045CT	KSRD 1050CT	KSRD 1060CT	KSRD 1080CT	KSRD 10100CT	KSRD 10150CT	KSRD 10200CT	Units
Maximum repetitive peak reverse voltage	$V_{RRM}$	20	30	45	50	60	80	100	150	200	Volts
Maximum RMS voltage	$V_{RMS}$	14	21	31.5	35	42	56	70	105	140	Volts
Maximum DC blocking voltage	$V_{DC}$	20	30	45	50	60	80	100	150	200	Volts
Maximum average forward rectified current(see Fig.1)	$I_{(AV)}$	5.0 10.0									Amps
Peak forward surge current 8.3ms single half sine-wave superimposed on rated load (JEDEC method)	$I_{FSM}$	160.0									Amps
Maximum instantaneous forward voltage at 10.0A	$V_F$	0.60		0.70		0.85		0.90		0.95	Volts
Maximum instantaneous reverse current at rated DC blocking voltage(Note 1)	$T_c=25^\circ C$	0.1									mA
	$T_c=125^\circ C$	15			20						
Typical thermal resistance (Note 2)	$R_{\theta JC}$	3.0									°C/W
Operating junction temperature range	$T_J$	-65 to +150									°C
Storage temperature range	$T_{STG}$	-65 to +150									°C

- Notes:** 1.Pulse test: 300  $\mu s$  pulse width,1% duty cycle  
 2.Thermal resistance from junction to case

FIG.1-FORWARD CURRENT DERATING CURVE

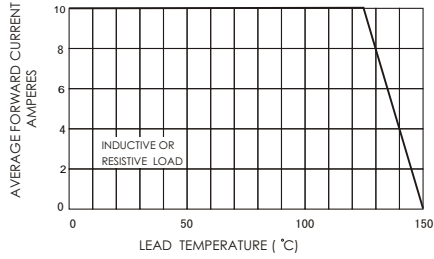

FIG.2-MAXIMUM NON-REPETITIVE PEAK FORWARD SURGE CURRENT

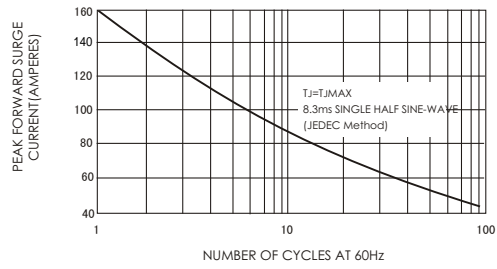

FIG.3-TYPICAL INSTANTANEOUS FORWARD CHARACTERISTICS

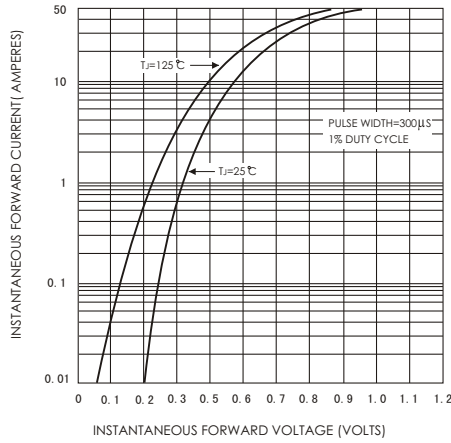

FIG.4-TYPICAL REVERSE CHARACTERISTICS

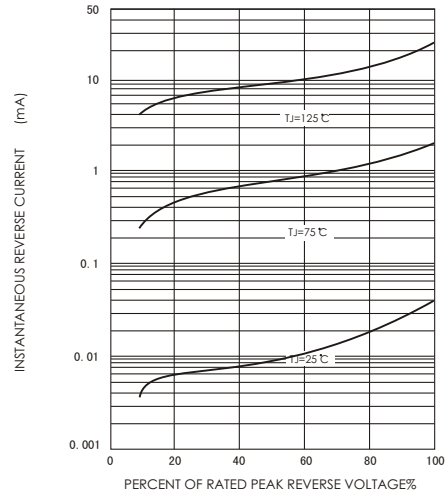

FIG.5-TYPICAL JUNCTION CAPACITANCE

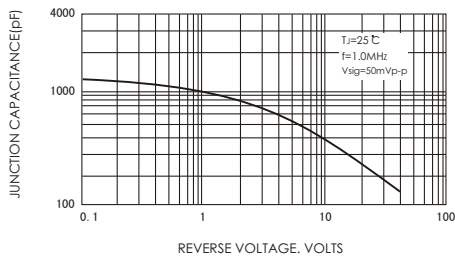
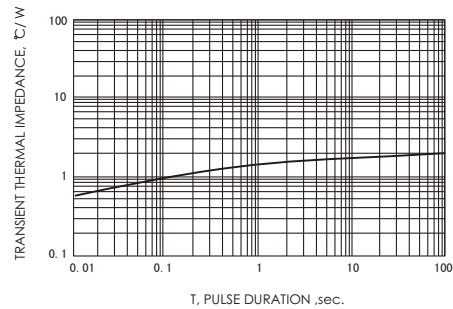
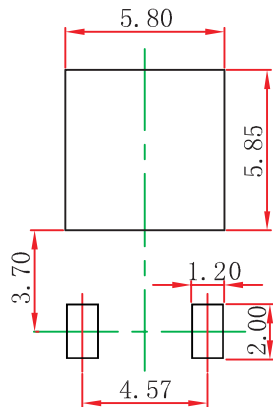

FIG.6-TYPICAL TRANSIENT THERMAL IMPEDANCE



### TO-252-2L Suggested Pad Layout



**Note:**

1. Controlling dimension: in millimeters.
2. General tolerance:  $\pm 0.05\text{mm}$ .
3. The pad layout is for reference purposes only.

## TO-252-2L Tape and Reel

### TO-252 Embossed Carrier Tape

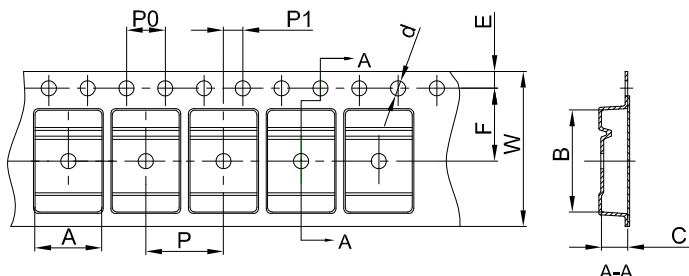

**Packaging Description:**

TO-252 parts are shipped in tape. The carrier tape is made from a dissipative (carbon filled) polycarbonate resin. The cover tape is a multilayer film (Heat Activated Adhesive in nature) primarily composed of polyester film, adhesive layer, sealant, and anti-static sprayed agent. These reeled parts in standard option are shipped with 25,00 units per 13" or 33.0 cm diameter reel. The reels are clear in color and is made of polystyrene plastic (anti-static coated).

Dimensions are in millimeter										
Pkg type	A	B	C	d	E	F	P0	P	P1	W
TO-252	6.90	10.50	2.70	Ø1.55	1.75	7.50	4.00	8.00	2.00	16.00

### TO-252 Tape Leader and Trailer

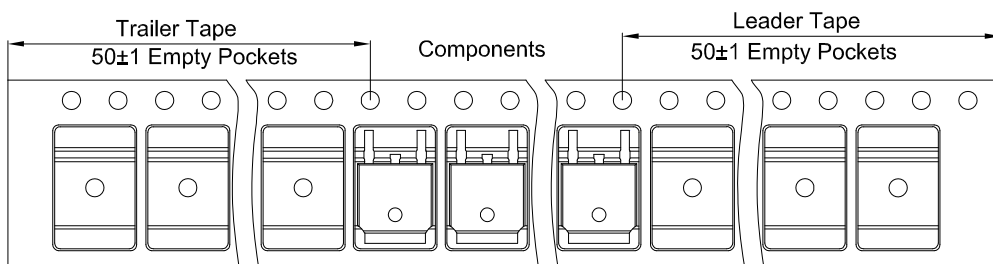

### TO-252 Reel

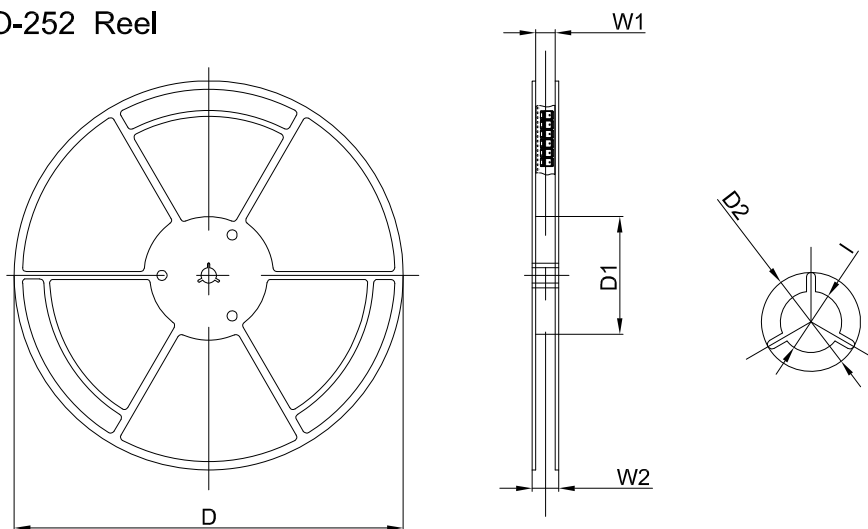

Dimensions are in millimeter						
Reel Option	D	D1	D2	W1	W2	I
13" Dia	330.00	100.00	Ø21.00	16.40	21.00	Ø13.00

REEL	Reel Size	Box	Box Size(mm)	Carton	Carton Size(mm)	G.W.(kg)
2,500 pcs	13inch	2,500 pcs	340×336×29	25,000 pcs	353×346×365	