

SOD-123FL Plastic-Encapsulate Diodes

Fast Recovery Rectifier Diodes

Features:

- $I_{F(AV)}$ 2A
- V_{RRM} 50V-1000V
- High surge current capability
- Polarity: Color band denotes cathode

Applications:

- Rectifier

Marking

- FMS2

1PL:2F1; 2PL:2F2; 3PL:2F3; 4PL:2F4; 5PL:2F5; 6PL:2F6; 7PL:2F7

SOD-123FL



Limiting Values(Absolute Maximum Rating)

Item	Symbol	Unit	Test Conditions	FMS2						
				1PL	2PL	3PL	4PL	5PL	6PL	7PL
Repetitive Peak Reverse Voltage	V_{RRM}	V		50	100	200	400	600	800	1000
Maximum RMS Voltage	V_{RMS}	V		35	70	140	280	420	560	700
Average Forward Current	$I_{F(AV)}$	A	60Hz Half-sine wave, Resistance load, $T_a=90^\circ\text{C}$	2.0						
Surge(Non-repetitive)Forward Current	I_{FSM}	A	60Hz Half-sine wave, 1 cycle, $T_a=25^\circ\text{C}$	50						
Junction Temperature	T_J	$^\circ\text{C}$		-55 ~ +150						
Storage Temperature	T_{STG}	$^\circ\text{C}$		-55 ~ +150						

Electrical Characteristics ($T=25^\circ\text{C}$ Unless otherwise specified)

Item	Symbol	Unit	Test Condition	FMS2						
				1PL	2PL	3PL	4PL	5PL	6PL	7PL
Peak Forward Voltage	V_F	V	$I_F=2.0\text{A}$	1.3						
Maximum reverse recovery time	t_{rr}	ns	$I_F=0.5\text{A}, I_R=1.0\text{A}, I_{rr}=0.25\text{A}$	150			250		500	
Peak Reverse Current	I_{RRM1}	μA	$V_{RM}=V_{RRM}$	$T_a=25^\circ\text{C}$		5				
	I_{RRM2}			$T_a=125^\circ\text{C}$		50				
Thermal Resistance(Typical)	$R_{\theta J-A}$	$^\circ\text{C}/\text{W}$	Between junction and ambient		70					
	$R_{\theta J-L}$		Between junction and terminal		25					

Notes:

Thermal resistance from junction to ambient and from junction to lead mounted on P.C.B. with 0.2" x 0.2" (5.0 mm x 5.0 mm) copper pad areas

Typical Characteristics

FIG.1: FORWARD CURRENT DERATING CURVE

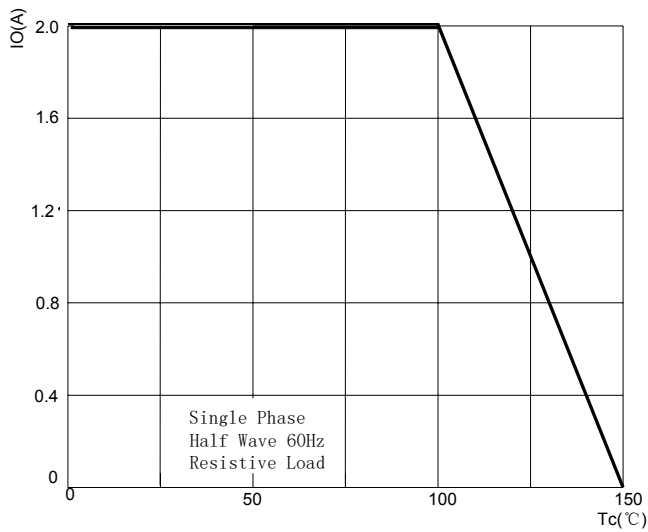

FIG.2: MAXIMUM NON-REPETITIVE FORWARD URGE CURRENT

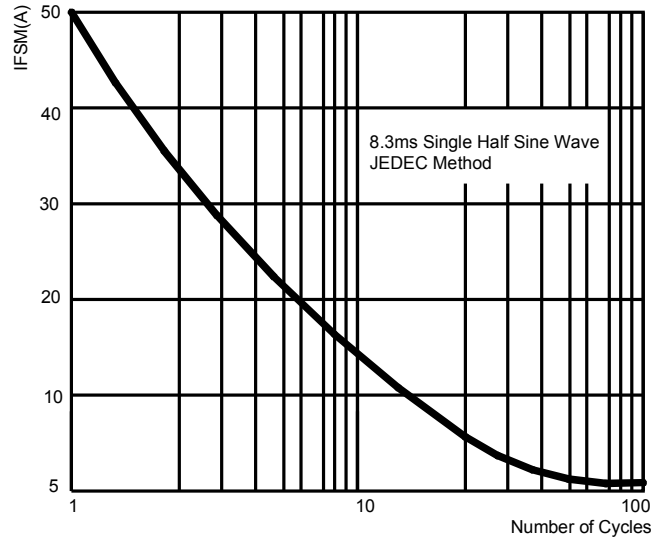

FIG.3: TYPICAL FORWARD CHARACTERISTICS

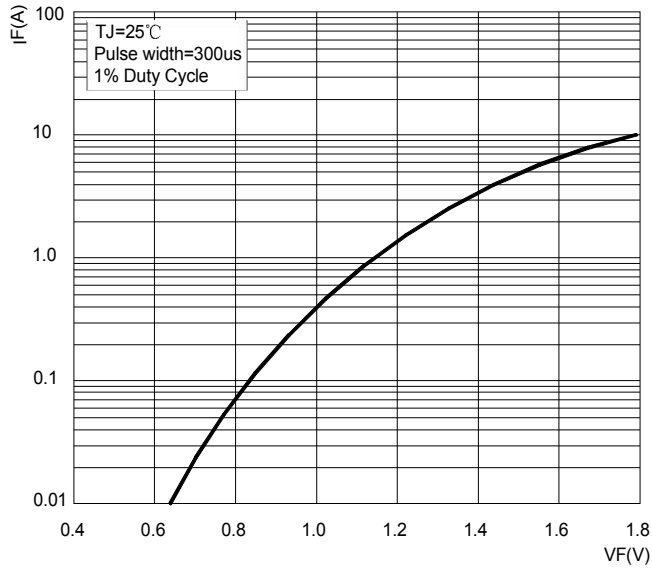

FIG.4: TYPICAL REVERSE CHARACTERISTICS

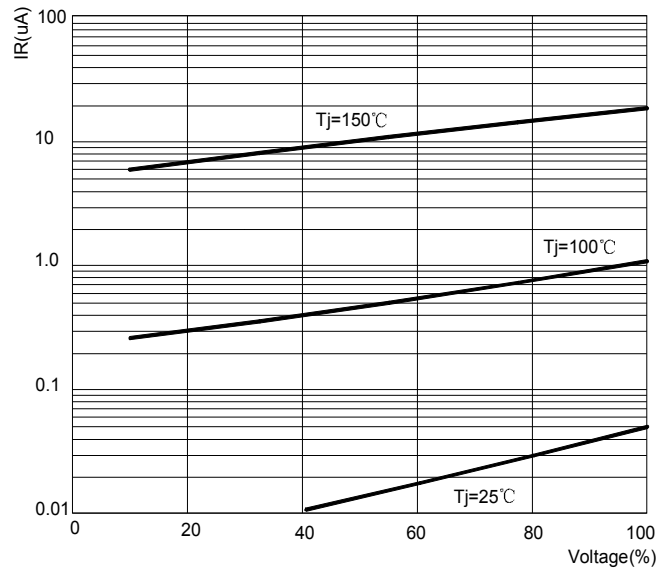
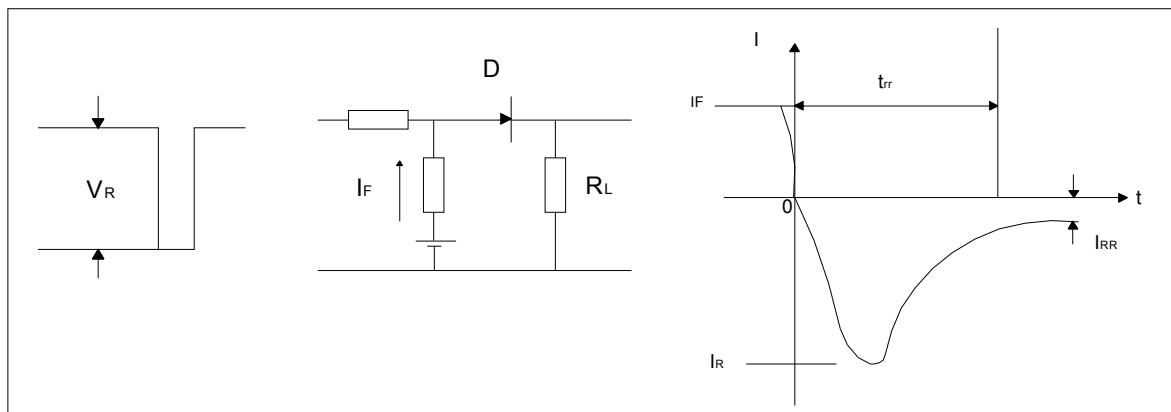
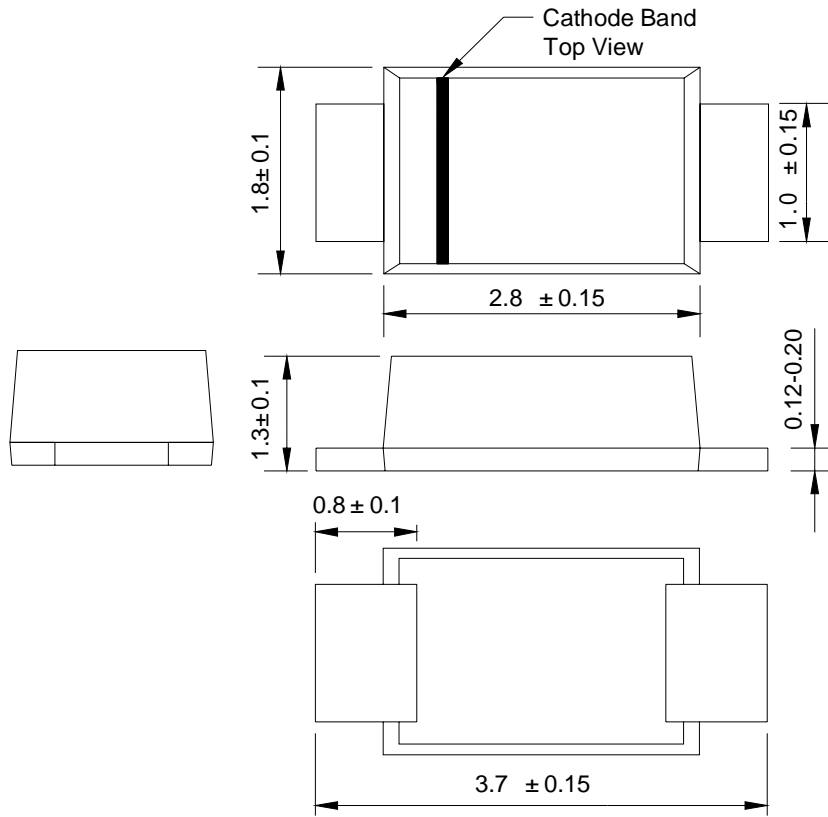

FIG.5: Diagram of circuit and Testing wave form of reverse recovery time



SOD-123FL Package Outline Dimensions



Dimensions in millimeters

SOD-123FL Suggested Pad Layout

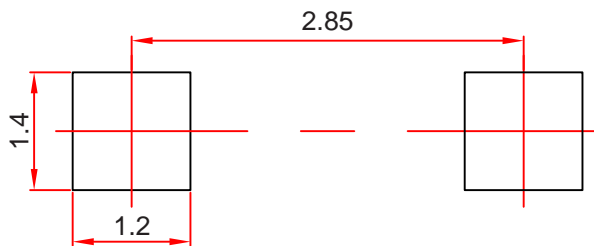

Note:

1. Controlling dimension: in millimeters.
2. General tolerance: ± 0.05 mm.
3. The pad layout is for reference purposes only.

Reel Taping Specifications For Surface Mount Devices-SOD-123FL

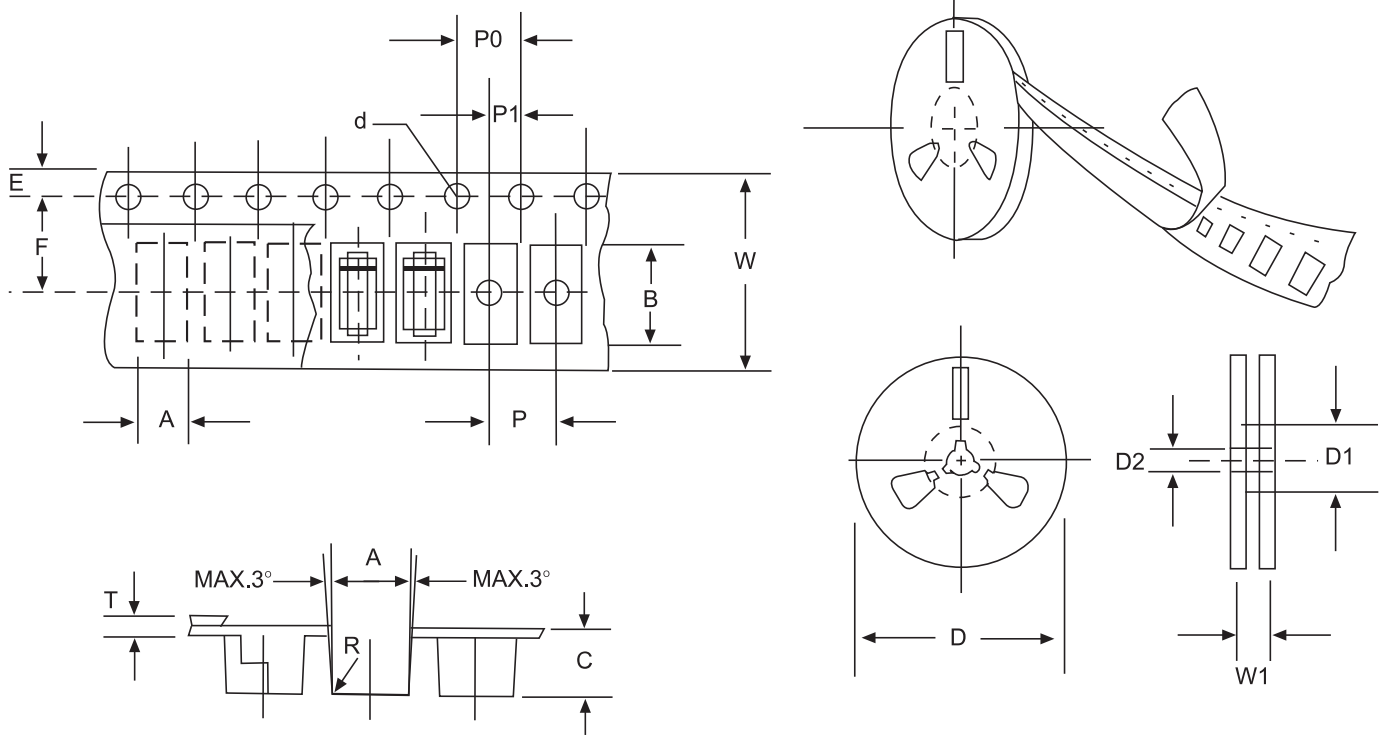

FIG: CONFIGURATION OF SURFACE MOUNTED DEVICES TAPING

ITEM	SYMBOL	SOD-123FLmm(inch)
Carrier width	A	2.05±0.1(0.081±0.004)
Carrier length	B	3.95±0.1(0.156±0.004)
Carrier depth	C	1.45±0.1(0.057±0.004)
Sprocket hole	d	1.55±0.05(0.061±0.002)
Reel outside diameter	D	178±2.0(7.0±0.079)
Reel inner diameter	D1	54±1.0(2.13±0.039)
Feed hole diameter	D2	13±0.5(0.512±0.020)
Sprocket hole position	E	1.75±0.1(0.069±0.004)
Punch hole position	F	3.50±0.1(0.138±0.002)
Punch hole pitch	P	4.0±0.1(0.157±0.004)
Sprocket hole pitch	P0	4.0±0.1(0.157±0.004)
Embossment center	P1	2.0±0.1(0.079±0.004)
Totall tape thickness	T	0.21±0.25(0.008±0.010)
Tape width	W	8.0±0.2(0.315±0.008)
Reel width	W1	10.0±2.0(0.394±0.079)

NOTE: Devices are packed in accordance with EIA standard RS-481-A and specification given above.