

# TO-220AB/ITO-220AB Plastic-Encapsulate Diode

SCHOTTKY BARRIER RECTIFIER

## Features:

- Low Power Loss, High Efficiency
- Guard Ring Die Construction for Transient Protection
- High Current Capability and Low Forward Voltage Drop

## MAIN CHARACTERISTICS

$I_O$	16(2*8)A
$V_{RRM}$	45V
$T_j$	150 °C
$V_{F(typ)}$	0.45V (@ $T_j=125^\circ\text{C}$ )

## MARKING

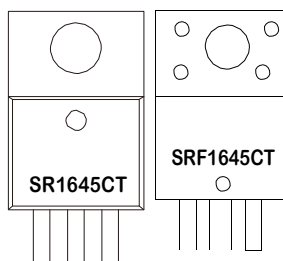

TO-220AB      ITO-220AB

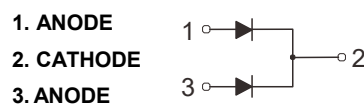
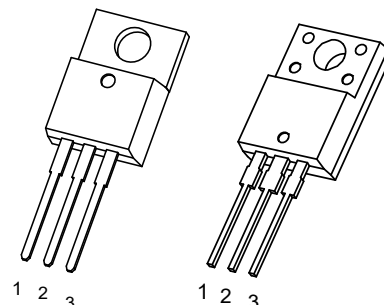

## MAXIMUM RATINGS ( $T_a=25^\circ\text{C}$ unless otherwise noted )

Symbol	Parameter	SR		Unit
		1645CT	F1645CT	
$V_{RRM}$	Peak repetitive reverse voltage	45		V
$V_{RWM}$	Working peak reverse voltage			
$V_R$	DC blocking voltage			
$V_{R(RMS)}$	RMS reverse voltage	31.5		V
$I_O$	Average rectified output current	16		A
$I_{FSM}$	Non-Repetitive peak forward surge current (8.3ms half sine wave)	150		A
$R_{\theta Jc}$	Thermal resistance from junction to case, $T_c=25^\circ\text{C}$	2.0	3.0	$^\circ\text{C}/\text{W}$
$R_{\theta JA}$	Thermal resistance from junction to ambient	62.5		$^\circ\text{C}/\text{W}$
$T_j$	Junction temperature	150		$^\circ\text{C}$
$T_{stg}$	Storage temperature	-55~+150		$^\circ\text{C}$

## ELECTRICAL CHARACTERISTICS ( $T_a=25^\circ\text{C}$ unless otherwise specified )

Parameter	Symbol	Test conditions	Min	Typ	Max	Unit
Reverse voltage	$V_{(BR)}$	$I_R=1\text{mA}$	45			V
Reverse current	$I_R$	$V_R=45\text{V}$	$T_j=25^\circ\text{C}$	0	200	$\mu\text{A}$
			$T_j=125^\circ\text{C}$	10		mA
Forward voltage	$V_F$	$I_F=4\text{A}$	$T_j=25^\circ\text{C}$	0.45		V
			$T_j=125^\circ\text{C}$	0.40		V
		$I_F=8\text{A}$	$T_j=25^\circ\text{C}$	0.52	0.60	V
			$T_j=125^\circ\text{C}$	0.45		V

\*Pulse test: pulse width  $\leq 300\mu\text{s}$ , duty cycle  $\leq 2.0\%$ .

## Typical Characteristics

FIG.1: FORWARD CURRENT DERATING CURVE

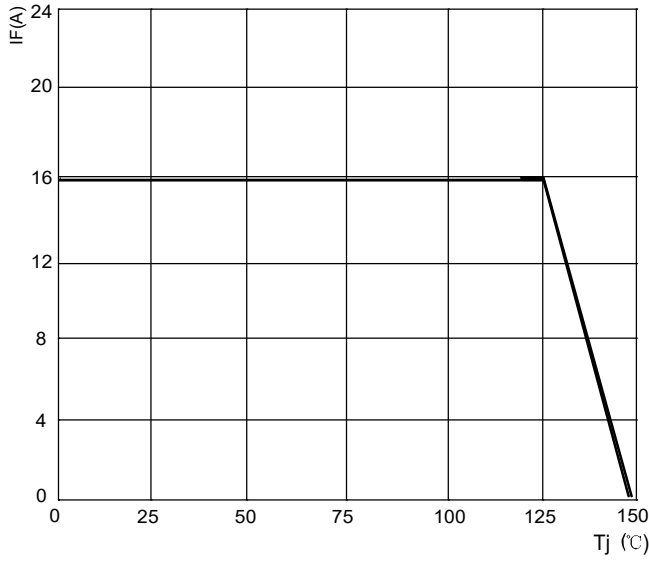

FIG.2: TYPICAL FORWARD CHARACTERISTICS

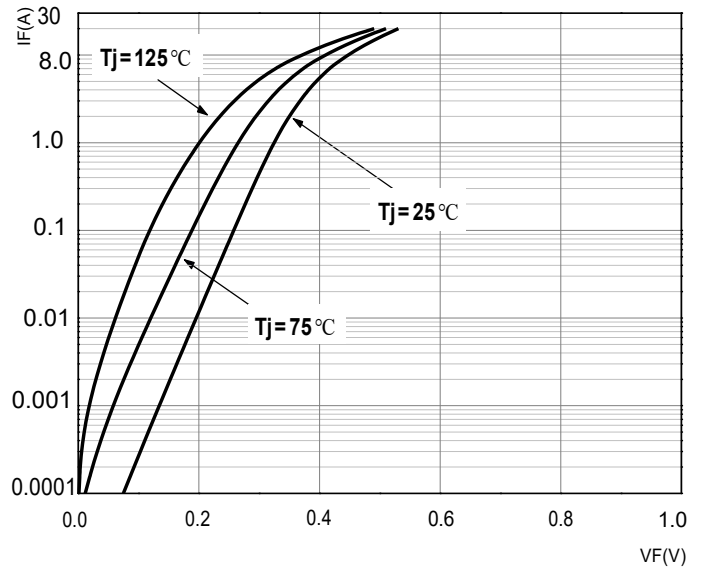

FIG.3: TOTAL CAPACITANCE DERATING CURVE

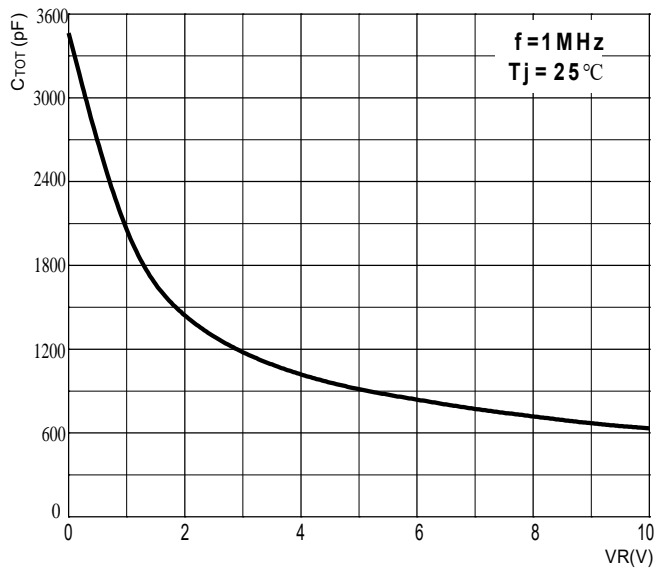
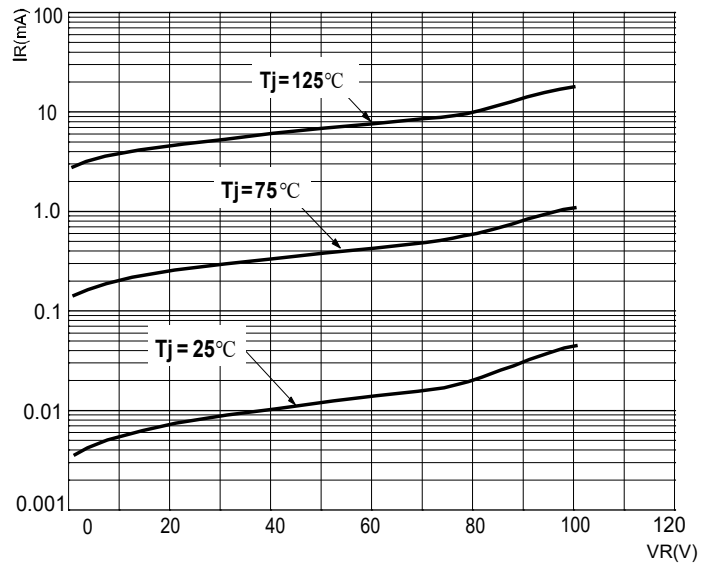
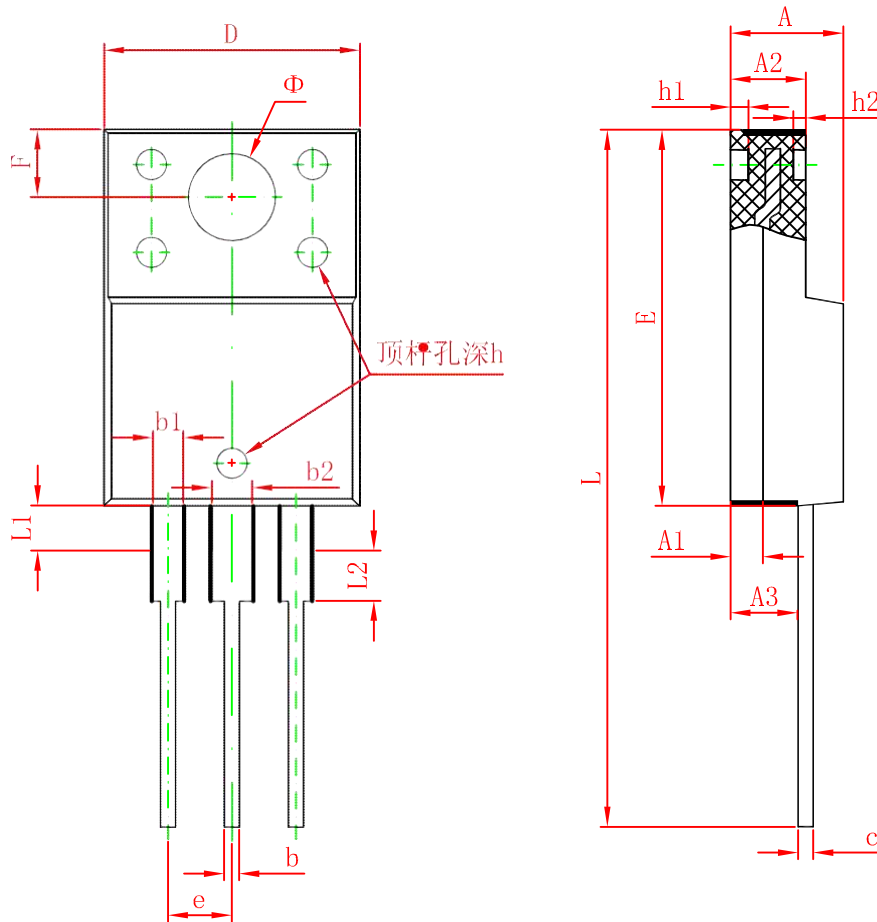

FIG.4: TYPICAL REVERSE CHARACTERISTICS







Symbol	Dimensions In Millimeters		Dimensions In Inches	
	Min.	Max.	Min.	Max.
A	4.300	4.700	0.169	0.185
A1	1.300 REF.		0.051 REF.	
A2	2.800	3.200	0.110	0.126
A3	2.500	2.900	0.098	0.114
b	0.500	0.750	0.020	0.030
b1	1.100	1.350	0.043	0.053
b2	1.500	1.750	0.059	0.069
c	0.500	0.750	0.020	0.030
D	9.960	10.360	0.392	0.408
E	14.800	15.200	0.583	0.598
e	2.540 TYP.		0.100 TYP.	
F	2.700 REF.		0.106 REF.	
$\Phi$	3.500 REF.		0.138 REF.	
h	0.000	0.300	0.000	0.012
h1	0.800 REF.		0.031 REF.	
h2	0.500 REF.		0.020 REF.	
L	28.000	28.400	1.102	1.118
L1	1.700	1.900	0.067	0.075
L2	1.900	2.100	0.075	0.083