

GBU Plastic-Encapsulate Bridge Rectifier

General Purpose Bridge Rectifier

Features:

- I_o 15A
- V_{RRM} 50V-1000V
- High surge current capability
- Glass passivated chip

Applications:

- General purpose 1 phase Bridge rectifier applications

Marking

- GBU15Lxx
- XX : From 005 To 10

GBU

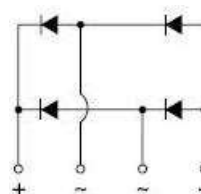
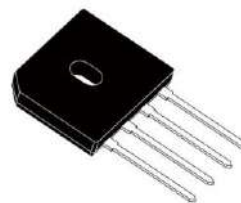

Limiting Values (Absolute Maximum Rating)

Item	Symbol	Unit	Conditions	GBU15L						
				005	01	02	04	06	08	10
Repetitive Peak Reverse Voltage	V_{RRM}	V		50	100	200	400	600	800	1000
Maximum RMS Voltage	V_{RMS}	V		35	70	140	280	420	560	700
Average Rectified Output Current	I_o	A	60Hz sine wave, R-load $T_c = 100^\circ\text{C}$	15						
Surge(Non-repetitive)Forward Current	I_{FSM}	A	60Hz half-sine wave, 1 cycle, $T_j = 25^\circ\text{C}$	200						
Current Squared Time	I^2t	A^2S	$1\text{ms} \leq t < 8.3\text{ms}$ $T_j = 25^\circ\text{C}$, Rating of per diode	170						
Storage Temperature	T_{stg}	$^\circ\text{C}$		-55 ~ +150						
Junction Temperature	T_j	$^\circ\text{C}$		-55 ~ +150						
Dielectric Strength	V_{dis}	KV	Terminals to case, AC 1 minute	2						
Mounting Torque	Tor	$\text{kg} \cdot \text{cm}$	Recommend torque: $5\text{kg} \cdot \text{cm}$	8						

Electrical Characteristics ($T_a = 25^\circ\text{C}$ Unless otherwise specified)

Item	Symbol	Unit	Test Condition	Max
Peak Forward Voltage	V_{FM}	V	$I_{FM} = 7.5\text{A}$, Pulse measurement, Rating of per diode	0.90
Peak Reverse Current	I_{RRM}	μA	$V_{RM} = V_{RRM}$, Pulse measurement, Rating of per diode	10
Thermal Resistance	$R_{\theta J-A}$	$^\circ\text{C/W}$	Between junction and ambient, Without heatsink	23
	$R_{\theta J-C}$		Between junction and case, With heatsink	1.2

Typical Characteristics

FIG.1-MAXIMUM FORWARD SURGE CURRENT

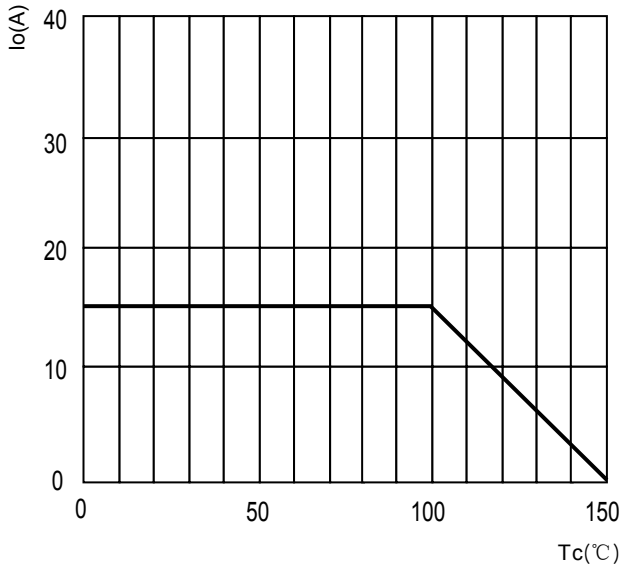

FIG.2-MAXIMUM NON-REPETITIVE SURGE CURRENT

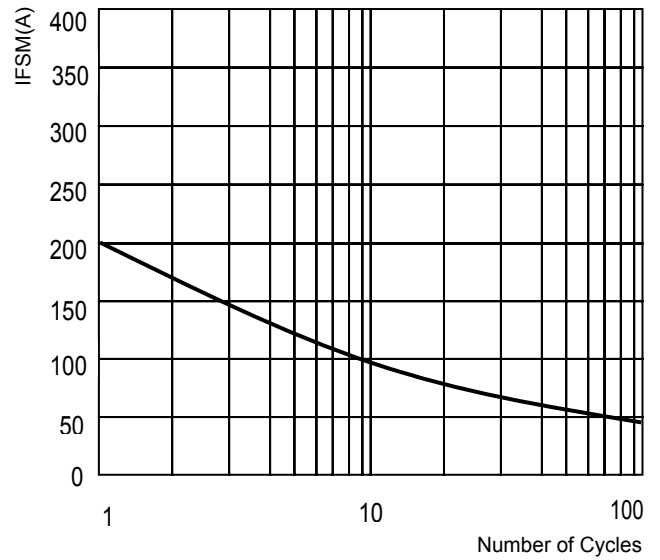

FIG.3-TYPICAL FORWARD CHARACTERISTICS

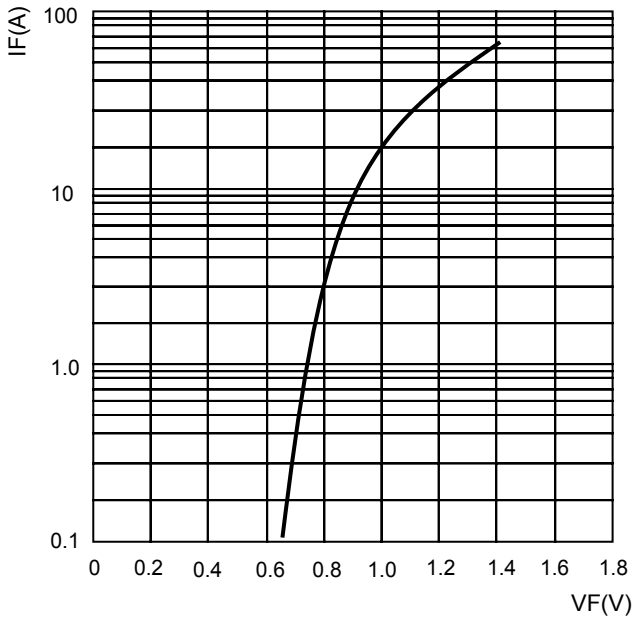
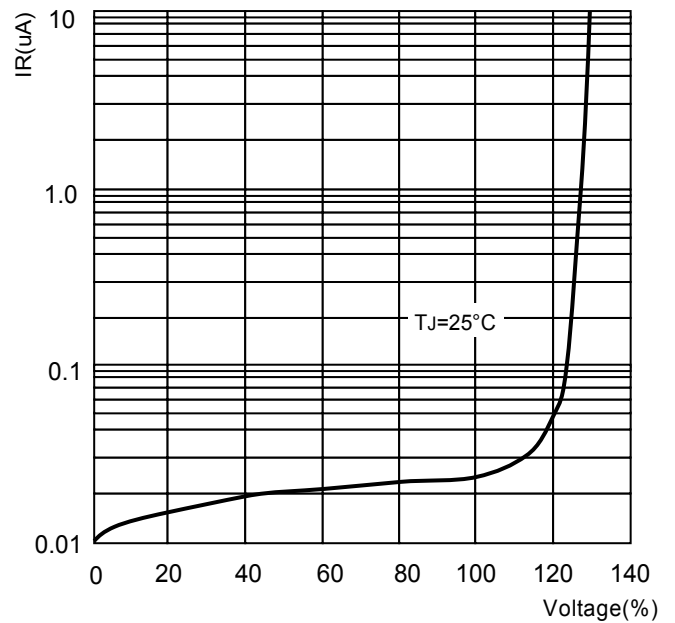
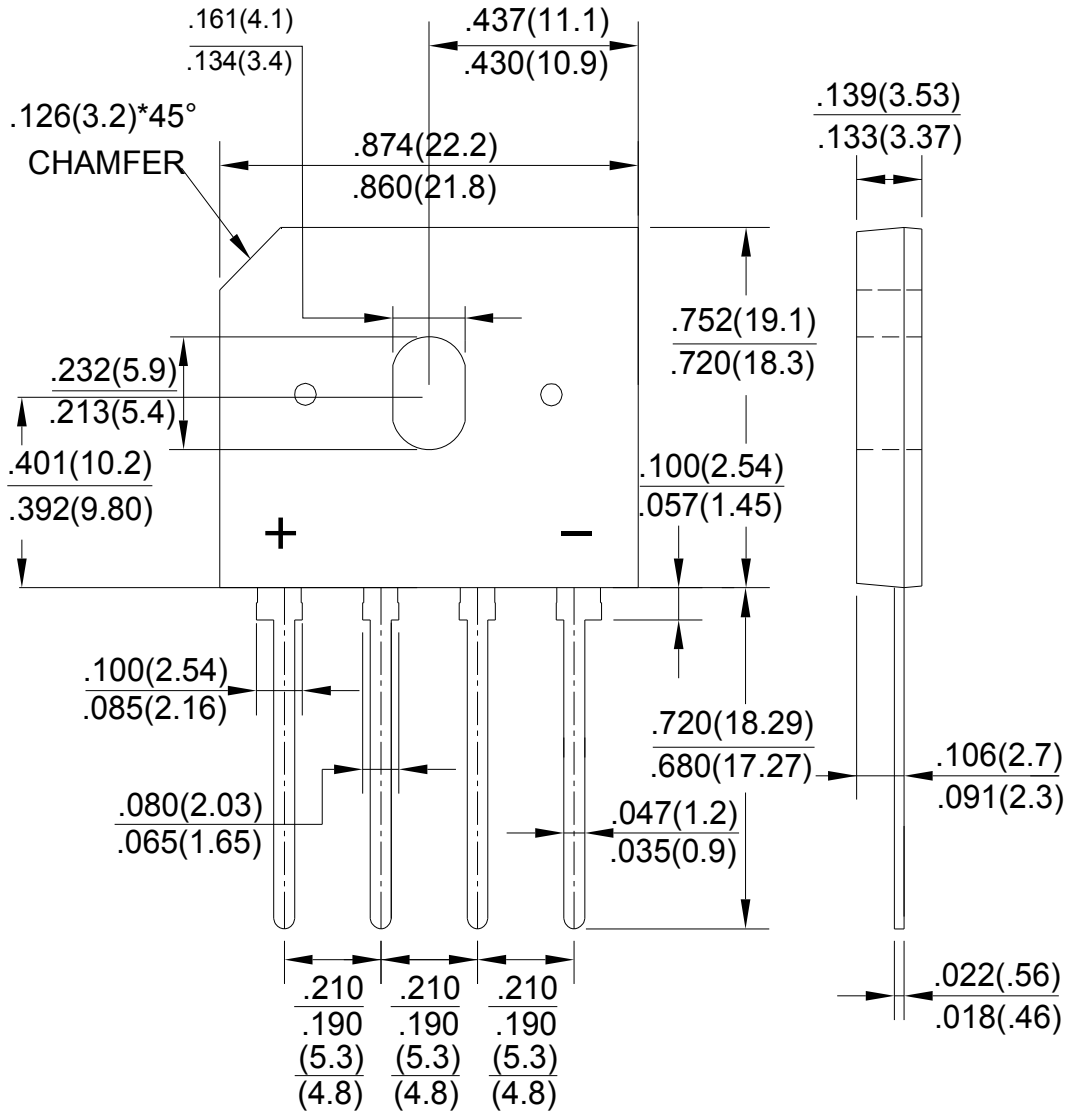

FIG.4-TYPICAL REVERSE CHARACTERISTICS



GBU Package Outline Dimensions



Unit: in inches (millimeters)