

SMB Plastic-Encapsulate Diodes

Super Fast Recovery Rectifier Diodes

Features:

- $I_{F(AV)}$ 3A
- V_{RRM} 50V-600V
- High surge current capability
- Polarity: Color band denotes cathode

Applications:

- Rectifier

Marking

- ES3X
- X : From A To J

SMB



Limiting Values(Absolute Maximum Rating)

Item	Symbol	Unit	Test Conditions	ES3							
				A	B	C	D	E	G	H	J
Repetitive Peak Reverse Voltage	V_{RRM}	V		50	100	150	200	300	400	500	600
Maximum RMS Voltage	V_{RMS}	V		35	70	105	140	210	280	350	420
Average Forward Current	$I_{F(AV)}$	A	60Hz Half-sine wave , Resistance load , $T_a=100^{\circ}C$	3.0							
Surge(Non-repetitive)Forward Current	I_{FSM}	A	60Hz Half-sine wave , 1 cycle , $T_a=25^{\circ}C$	100							
Operation Junction and Storage Temperature Range	T_J, T_{STG}	$^{\circ}C$		-55 ~ +150							

Electrical Characteristics ($T=25^{\circ}C$ Unless otherwise specified)

Item	Symbol	Unit	Test Condition	ES3							
				A	B	C	D	E	G	H	J
Peak Forward Voltage	V_F	V	$I_F=3.0A$	0.95				1.25		1.7	
Maximum reverse recovery time	t_{rr}	ns	$I_F=0.5A, I_R=1.0A, I_{rr}=0.25A$	35							
Peak Reverse Current	I_{RRM1}	μA	$V_{RM}=V_{RRM}$	$T_a=25^{\circ}C$							
	I_{RRM2}			$T_a=100^{\circ}C$							
Thermal Resistance(Typical)	$R_{\theta J-A}$	$^{\circ}C/W$	Between junction and ambient				47				
	$R_{\theta J-L}$		Between junction and terminal				12				

Notes:

Thermal resistance from junction to ambient and from junction to lead mounted on P.C.B. with 0.27" x 0.27" (7.0 mm x 7.0 mm) copper pad areas

Typical Characteristics

FIG.1: FORWARD CURRENT DERATING CURVE

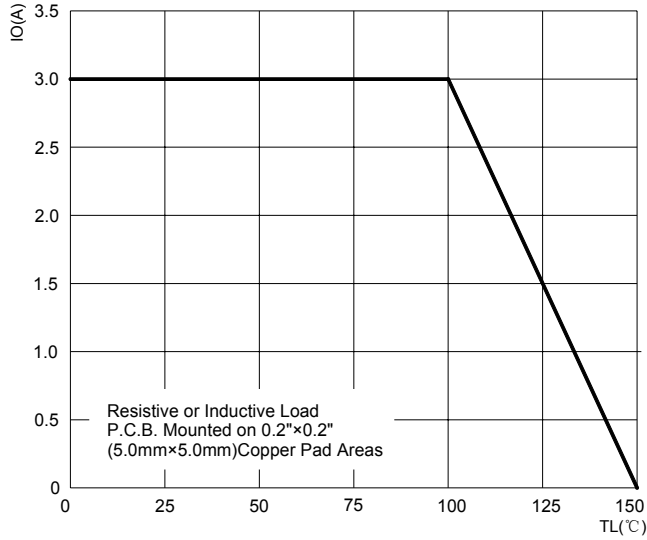

FIG.2: MAXIMUM NON-REPETITIVE FORWARD URGE CURRENT

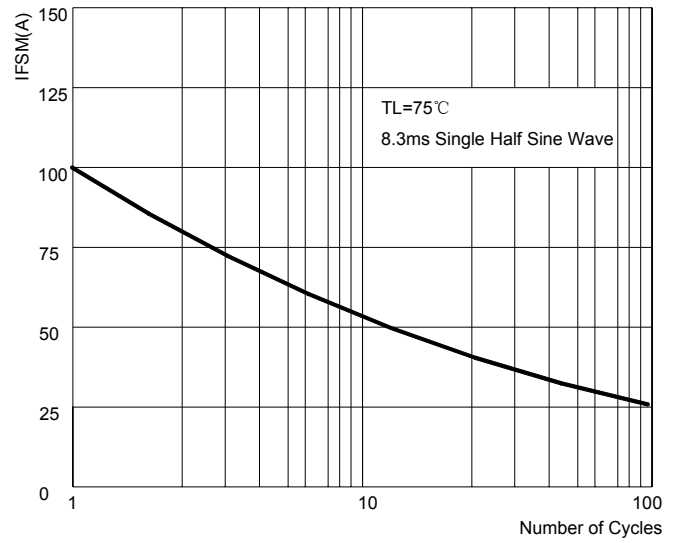

FIG.3: TYPICAL FORWARD CHARACTERISTICS

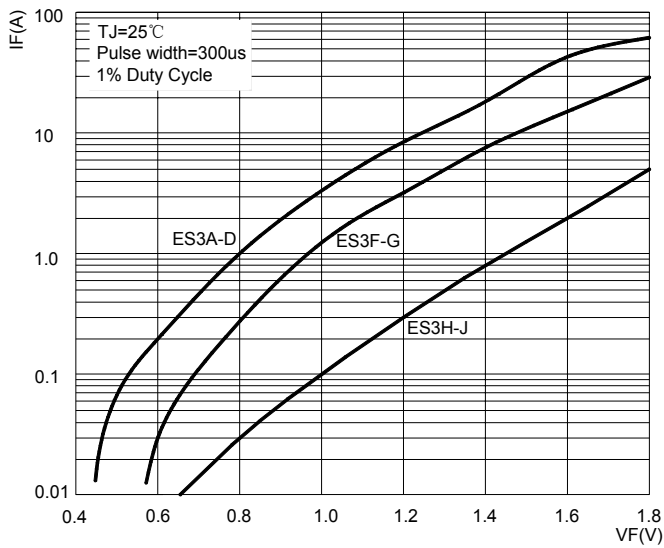

FIG.4: TYPICAL REVERSE CHARACTERISTICS

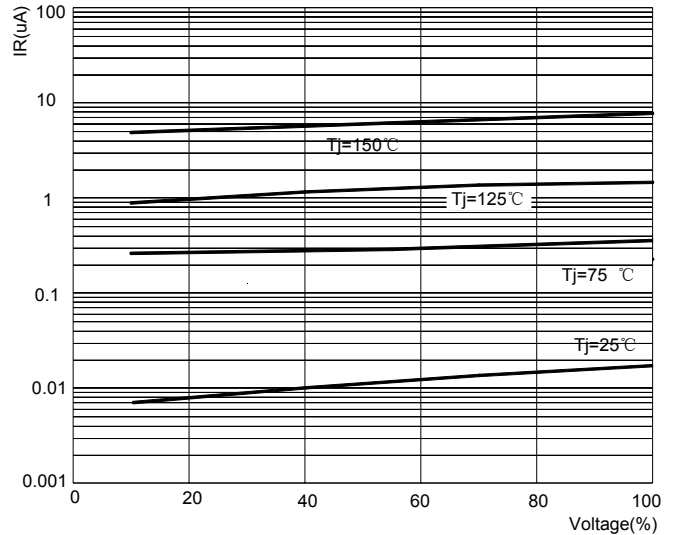
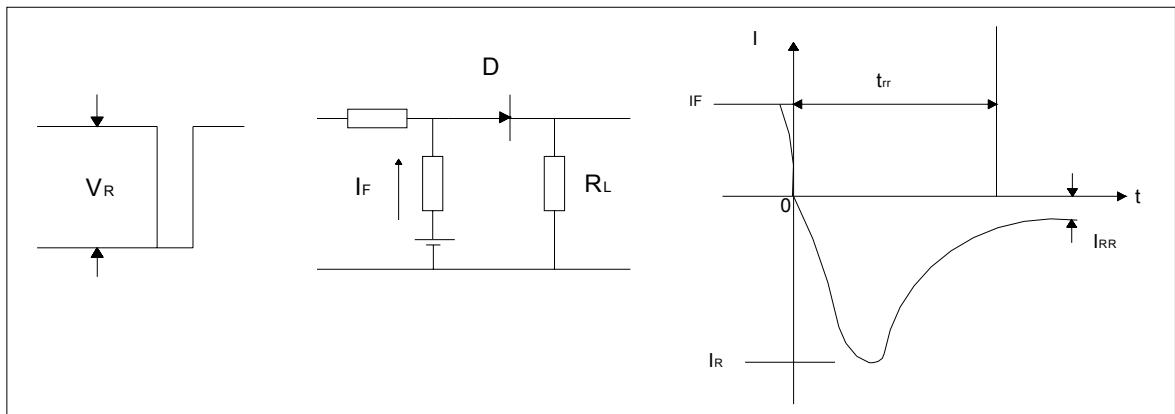
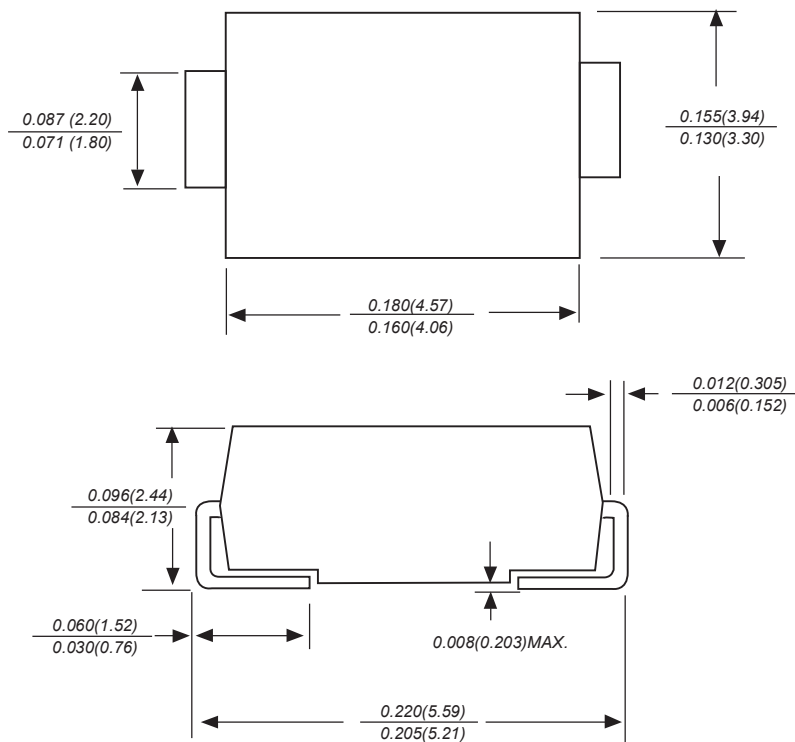

FIG.5: Diagram of circuit and Testing wave form of reverse recovery time



SMB Package Outline Dimensions



Dimensions in inches and (millimeters)

SMB Suggested Pad Layout

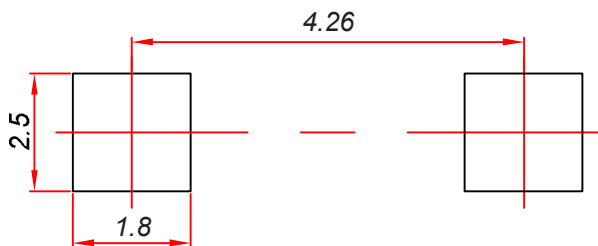

Note:

1. Controlling dimension: in millimeters.
2. General tolerance: ± 0.05 mm.
3. The pad layout is for reference purposes only.

Reel Taping Specifications For Surface Mount Devices-SMB

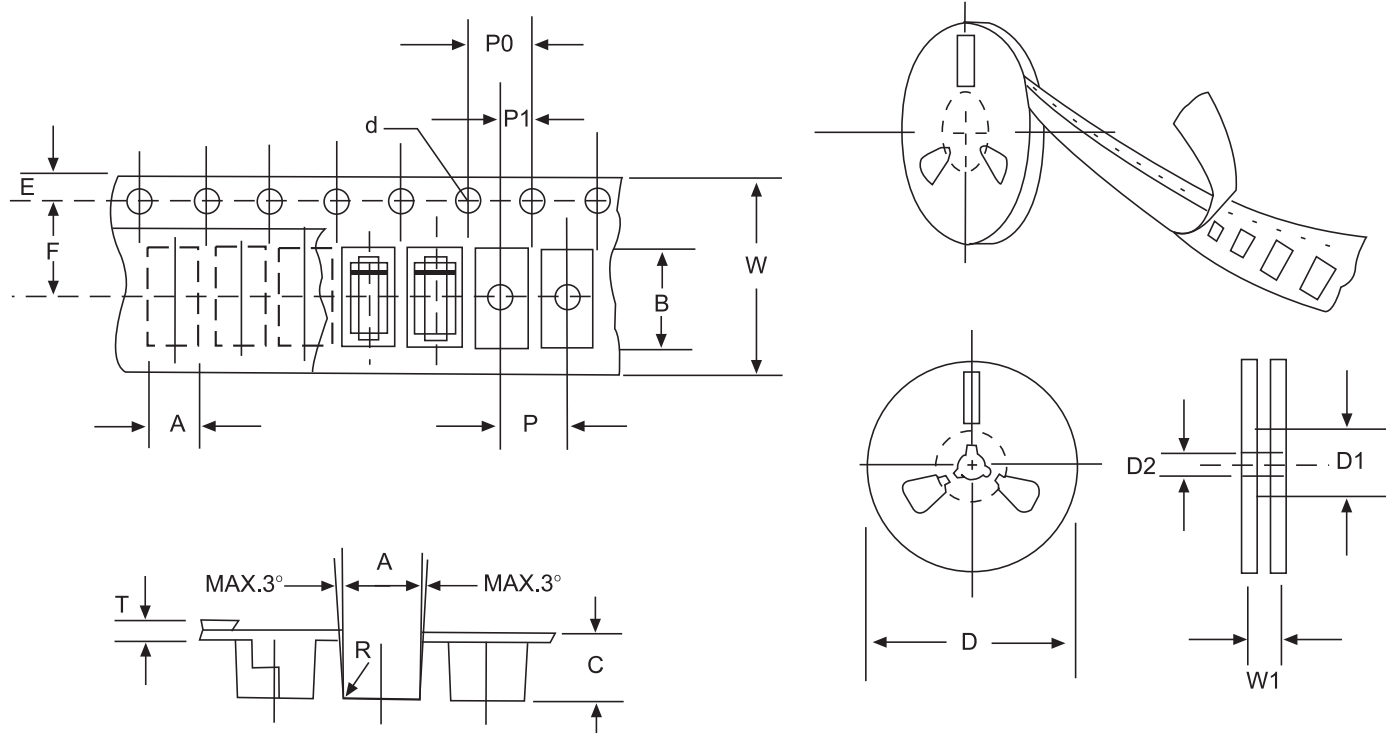

FIG: CONFIGURATION OF SURFACE MOUNTED DEVICES TAPING

ITEM	SYMBOL	SMB mm(inch)
Carrier width	A	4.09±0.1(0.161±0.004)
Carrier length	B	5.82±0.1(0.229±0.004)
Carrier depth	C	2.50±0.1(0.100±0.004)
Sprocket hole	d	1.55±0.05(0.061±0.002)
Reel outside diameter	D	330±2.0(13±0.079)
Reel inner diameter	D1	75 ±1.0 (2.95 ±0.039)
Feed hole diameter	D2	13±0.5(0.512±0.020)
Sprocket hole position	E	1.75±0.1(0.069±0.004)
Punch hole position	F	5.65±0.05(0.222±0.002)
Punch hole pitch	P	8.0±0.1(0.315±0.004)
Sprocket hole pitch	P0	4.0±0.1(0.157±0.004)
Embossment center	P1	2.0±0.1(0.079±0.004)
Total tape thickness	T	0.32±0.1(0.013±0.004)
Tape width	W	12.0±0.2(0.472±0.008)
Reel width	W1	16.8±2.0(0.661±0.079)

NOTE: Devices are packed in accordance with EIA standard RS-481-A and specification given above.