

## DBS Plastic-Encapsulate Bridge Rectifier

### General Purpose Bridge Rectifier

#### Features:

- $I_{F(AV)}$  2A
- $V_{RRM}$  50V-1000V
- High surge current capability
- Glass passivated chip

#### Applications:

- General purpose 1 phase Bridge rectifier applications

#### Marking

- DB20XS  
X : From 01 To 7

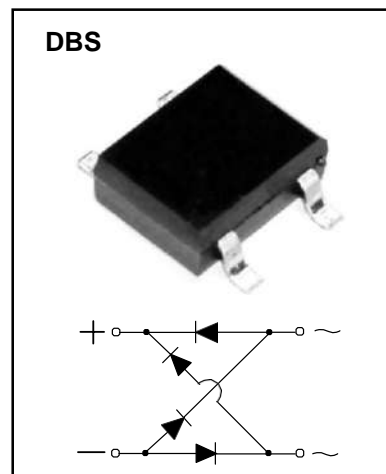

### Limiting Values (Absolute Maximum Rating)

Item	Symbol	Unit	Conditions	DB2						
				01S	02S	03S	04S	05S	06S	07S
Repetitive Peak Reverse Voltage	$V_{RRM}$	V		50	100	200	400	600	800	1000
Maximum RMS Voltage	$V_{RMS}$	V		35	70	140	280	420	560	700
Average Rectified Output Current	$I_o$	A	60Hz sine wave, R-load, $T_a=25^\circ\text{C}$	On glass-epoxi substrate		2.0				
Surge(Non-repetitive)Forward Current	$I_{FSM}$	A	60Hz halfsine wave, 1 cycle, $T_j=25^\circ\text{C}$		75					
Current Squared Time	$I^2t$	$\text{A}^2\text{S}$	$1\text{ms} \leq t < 8.3\text{ms}$ $T_j=25^\circ\text{C}$ , Rating of per diode		15					
Operation Junction and Storage Temperature Range	$T_j, T_{stg}$	$^\circ\text{C}$	-55 ~ +150							

### Electrical Characteristics ( $T_a=25^\circ\text{C}$ Unless otherwise specified)

Item	Symbol	Unit	Test Condition	Max
Peak Forward Voltage	$V_{FM}$	V	$I_{FM}=2.0\text{A}$ , Pulse measurement, Rating of per diode	1.0
Peak Reverse Current	$I_{RRM}$	$\mu\text{A}$	$V_{RM}=V_{RRM}$ , Pulse measurement, Rating of per diode	10
Thermal Resistance	$R_{\theta J-A}$	$^\circ\text{C}/\text{W}$	Between junction and ambient, On glass-epoxi substrate	68
	$R_{\theta J-L}$		Between junction and lead	15

**Typical Characteristics**

FIG.1: FORWARD CURRENT DERATING CURVE

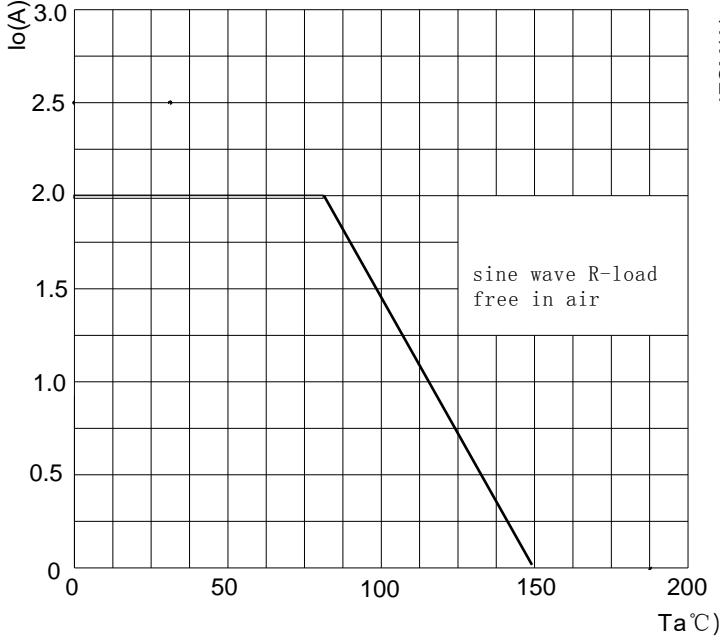

FIG.2: MAXIMUM NON-REPETITIVE FORWARD SURGE CURRENT

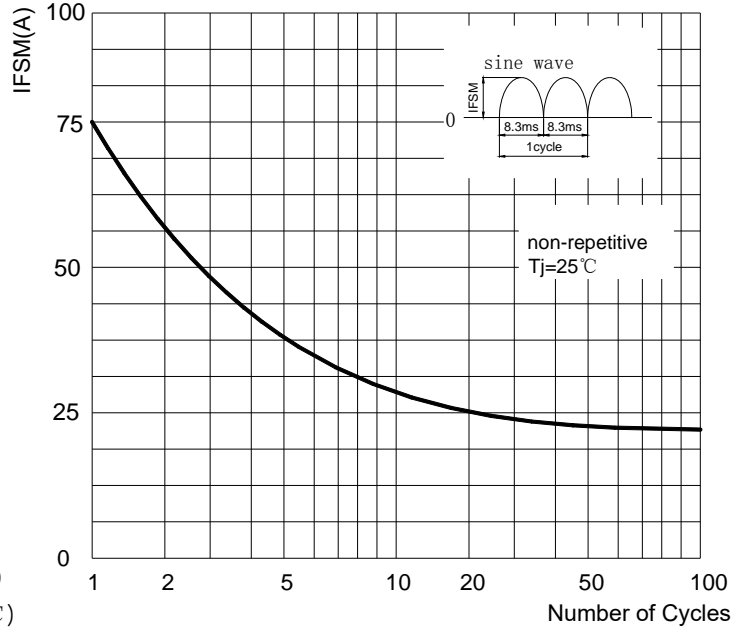

FIG.3: TYPICAL FORWARD CHARACTERISTICS

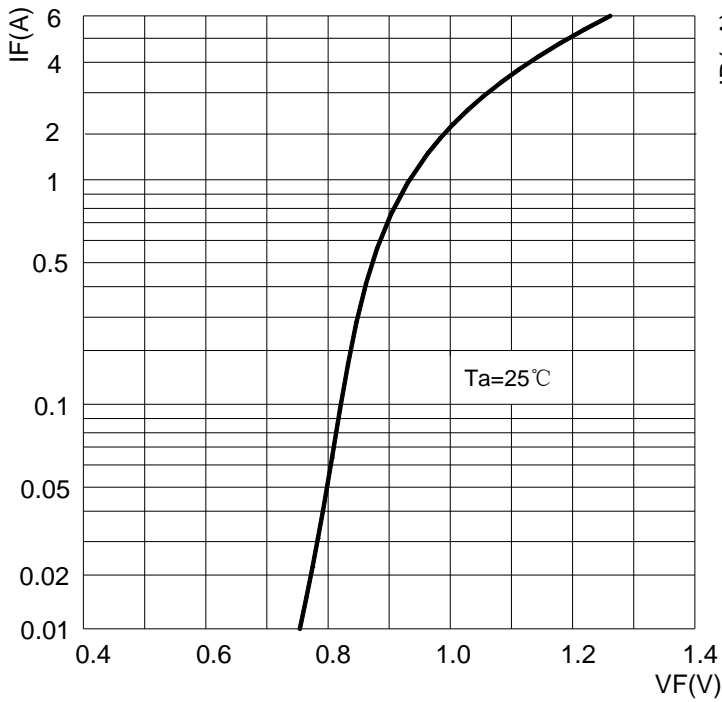
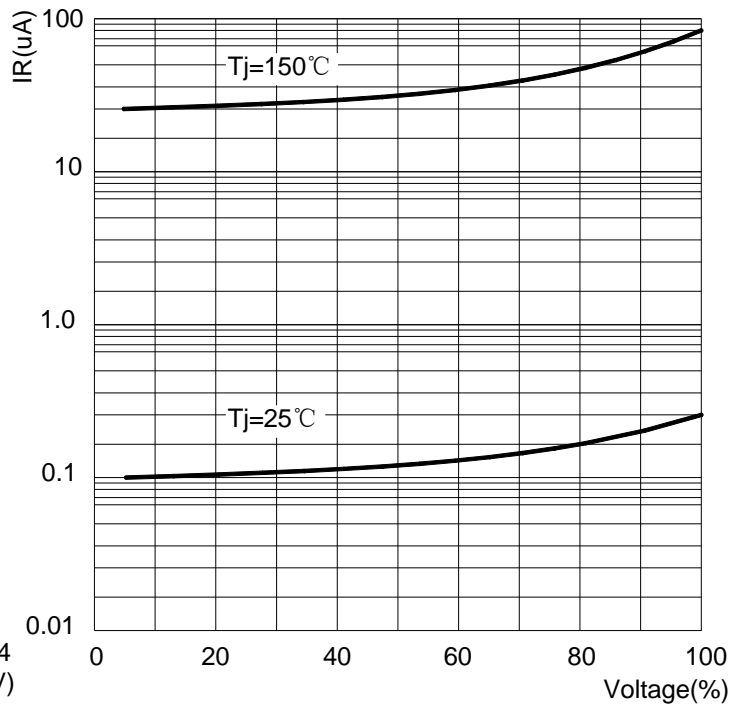
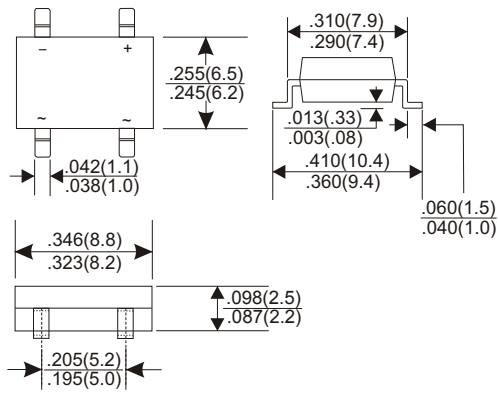

FIG.4: TYPICAL REVERSE CHARACTERISTICS



### DBS Package Outline Dimensions



Dimensions in inches and (millimeters)

### DBS Suggested Pad Layout

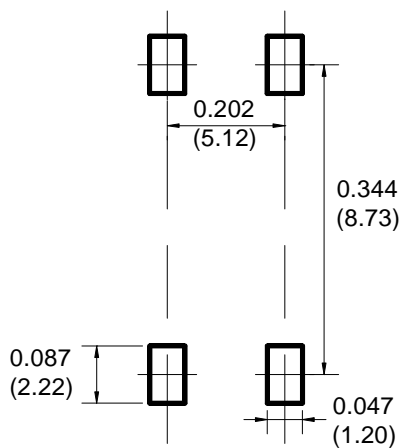

**Note:**

1. Controlling dimension: in millimeters.
2. General tolerance:  $\pm 0.05$ mm.
3. The pad layout is for reference purposes only.